

Quinko-Tek

I N T E R N A T I O N A L



Watts: 800.363.4979

info@quinkotek.com

www.quinkotek.com

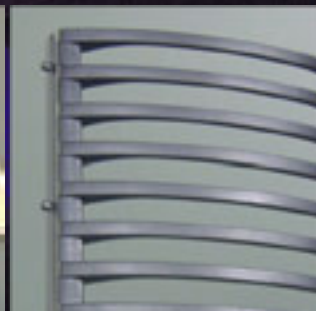

À notre clientèle,

C'est avec grand plaisir que nous vous présentons notre **Catalogue renouvelé**.

Grâce à votre soutien constant, **Quinko-Tek International** a durant les dernières années grandi et progressé au point de devenir un fournisseur de file dans l'industrie de la quincaillerie pour meubles et armoires.

Pour maintenir votre confiance et fidélité, ainsi que nos engagements envers notre clientèle, nous continuons à parcourir le globe à la recherche de produits innovateurs et de qualité qui font partie de nos lignes habituelles. Il va de soi que nous continuerons à vous offrir un service supérieur et fiable, ce qui fait de **Quinko-Tek** votre fournisseur de choix.

Veillez noter que ce catalogue comprend notre ligne de produits **Q line**. Cette sélection inclut des charnières invisibles, des coulisses de tiroir, des pattes de meubles et autres composantes, des poignées et autres produits décoratives, des systèmes de serrures et plusieurs autres types de quincailleries développés par **Quinko-Tek** et fabriqués dans divers pays de l'Extrême Orient en partenariat avec nos fabricants asiatiques.

L'avantage pour nos clients est la qualité assurée à des prix imbattables. De plus, les politiques des prix et de mise en marché sont entièrement contrôlées par **Quinko-Tek**. Nous ne serons pas influencés, affectés ou dérangés par des décisions prises par des maisons corporatives situées ailleurs dans le monde et qui ne reflètent pas la réalité de notre marché.

Ceci est une stratégie intégrale pour **Quinko-Tek** et ses fidèles clients.

Nous espérons donc que ce catalogue saura vous plaire. Nous serons heureux de vous servir dans un avenir proche.

• • •

Dear Customer,

*It is our pleasure and with great pride that we present our **newly expanded Catalogue**.*

*Thanks to your support, **Quinko-Tek International** has grown over the years to become a leader in our industry, into one of the most progressive and informed furniture hardware suppliers in the market.*

In order to continue to earn your confidence and maintain our reputation, it is our commitment to you, the customer, that we will always be scanning the globe in search of the quality and innovative products you have become accustomed to finding amongst our product lines. We will also continue to offer the superior levels of service and reliability that have made us your furniture hardware supplier.

*Please note that this catalogue includes our **Q line** series of products. This selection includes: invisible hinges and drawer slides, furniture legs and other components, cabinet handles, knobs, and other decorative products, locking systems, and many other hardware items that **Quinko-Tek International** develops and produces in the Far East in partnership with our Asian manufacturers.*

*The advantage to our clients is assured quality at unbeatable prices. Moreover, our pricing and marketing policies are fully monitored by **Quinko-Tek**. We will not be influenced, affected or detracted by decisions taken by corporations located elsewhere which do not reflect our market's reality.*

*This is an essential strategy for **Quinko-Tek** and its loyal customers.*

We hope you enjoy our catalogue and we hope to serve you in the near future.



Andre Plaitis
Président / President



Ira Kroo
Directeur-général / C.E.O.

Remerciements / Acknowledgements

AllWebConcept Corporation
www.allwebconcept.com • info@allwebconcept.com

Technique / Technical : **Paul Desgroseilliers**
Conception / Design : **Dumitru Tăbăcelea**
Photographie / Photography : **Cezar Popovici**



CONTENU / CONTENTS**1****Pentures et produits associés / Hinges and related products**

- A 00 A-D Pentures **Q line®** / **Q line®** hinges
- A 01-09 Pentures **Salice** / **Salice** hinges
- A 10 Amortisseurs SMOVE / *SMOVE cabinet impact absorber*
- A 11-14 Systèmes pour portes relevables **Salice** / *Salice swing door systems*
- B 01-04 Pentures **Lama** / **Lama** hinges
- C 01-02 Pentures pivotantes / *Pivot hinges*
- C 03-06 Aimants, loquets, plaques de verre, coussinets / *Magnets, latches, glass door catches, bumpers*
- D 01-05 Pentures traditionnelles, pentures piano / *Traditional hinges, piano hinges*

2**Coulisses, serrures et quincaillerie pour portes coulissantes / Slides, locks and sliding door hardware**

- A 01-03 Coulisses euro autofermantes **Taiming** / **Taiming** self closing euro slides
- A 04 Coulisses euro autofermantes **Q line®** / **Q line®** self closing euro slides
- B 01-05 Coulisses à billes **Q line®** / **Q line®** ball bearing slides
- BB 01-02 Serrures **Q line®** / **Q line®** locks
- C 01-08 **Harn** : Coulisses euro et tiroir métallique / **Harn** : euro slides and metal drawer slides
- D 01-02 Coulisses à billes pleine extension **Waterloo** / **Waterloo** full extension ball bearing slides
- E 01 Coulisses traditionnelles / *Traditional slides*
- F 01-05 Quincaillerie pour portes coulissantes / *Sliding door hardware*

3**Produits de rangement et multimédia / Storage and multimedia products**

- A 01-14 Produits de rangement multimédia **Spectrum** / **Spectrum** multimedia storage systems
- B 01-03 Passe-fils et augets à crayons **Q line®** / **Q line®** grommets and pencil trays
- C 01-06 Produits ergonomiques **Modern Solid** / **Modern Solid** ergonomic products

4**Quincaillerie spécialisée / Specialized hardware**

- A 01-03 Support à tablette / *Shelf supports*
- B 01-07 Roulettes, pattes, sous-pattes et bases de table / *Casters, decorative legs, glides and table bases*
- C 01 Quincaillerie de lit / *Bed hardware*
- C 02-04 Bras de suspension pour portes relevables / *Swing door stay supports*
- C 05 Équerres pour supports à tablette / *Metal shelf brackets*
- C 06 Crochets à linge simple (vois aussi section **10 C 01**) / *Coat hooks (also see section 10 C 01)*
- D 01-02 Plateaux pivotants / *Swivel plates*
- E 01-06 Crémaillères, supports et accessoires / *Wall standards, supports and accessories*
- F 01 Crochets à vis et carrelage / *Screw-in hooks and egg crate louvers*

5**Titus**

- A 01-06 Boîtier & vis d'assemblage, systèmes d'assemblage, Quickfit / *Quickfit, assembly fittings, cams & screws*
- A 07-08 Produits de rangement multimédia / *Multimedia storage systems*



CONTENU / CONTENTS**6****Attaches, vis de fixation, ferrures d'assemblage et caches-vis / Fasteners, screws, assembly fittings and screw covers**

- A 01-03 Attaches, goujons / *Fasteners, dowels*
- B 01-02 Vis / *Screws*
- C 01-04 Équerres et ferrures d'assemblage / *Brackets and assembly fittings*
- D 01-02 Cache-vis / *Screw covers*
- E 01 Capuchons et vis décoratives / *Decorative cover caps and screws*

7**Éclairage, moulures / Lighting, moldings**

- A 01-06 Éclairage **Shemol** / *Shemol lighting*
- B 01-02 Moulures en plastique / *Plastic moldings*
- C « Disponible bientôt / *Available soon* »
- D 01-07 Moulures en aluminium / *Aluminum moldings*

8**Matériaux de surface / Surface materials**

- A 01-02 Stratifiés **Lamitech**® / *Lamitech*® laminates
- B 01 P.V.C. **Dura Edge**, mélamine, bandes de chant / *P.V.C. Dura Edge, melamine, wood veneer tapes*
- C 01-02 Recouvrements **Dynea** / *Dynea backers*
- D « Disponible bientôt / *Available soon* »
- E « Disponible bientôt / *Available soon* »
- F « Disponible bientôt / *Available soon* »
- G 01 Adhésifs solvants **Helmitin** / *Helmitin solvent adhesives*
- G 03-04 Adhésifs en vaporisateur **Level One** / *Level One aerosol adhesives*
- H « Disponible bientôt / *Available soon* »
- I 01-04 Accessoires de cuisine / *Kitchen accessories*

9**Outillage divers / Miscellaneous tools**

- A 01-03 Outillage et accessoires divers / *Miscellaneous tools and accessories*
- B 01-02 Correcteur **Seamfil**, crayons correcteurs / *Seamfil filler, touch-up pens*
- C 01-02 Abrasifs / *Abrasives*

10**10. Poignées, pattes et crochets Q line® / Q line® handles, legs and hooks**

- A 01 Notes et légende de finis / *Notes and finish legend*
- A02-06 Index des produits et détails techniques / *Product index and technical specifications*
- AA-AQ Poignées décoratives **Q line**® / *Q line*® decorative handles
- AR 01-02 Poignées de portes **Q line**® / *Q line*® door handles
- AS 01 Crochets décoratifs à manteaux **Q line**® / *Q line*® decorative coat hooks
- B 01-02 Pattes décoratives et accessoires **Q line**® / *Q line*® decorative legs and accessories

11**11. Feuilles de promotion / Promotion Flyers**

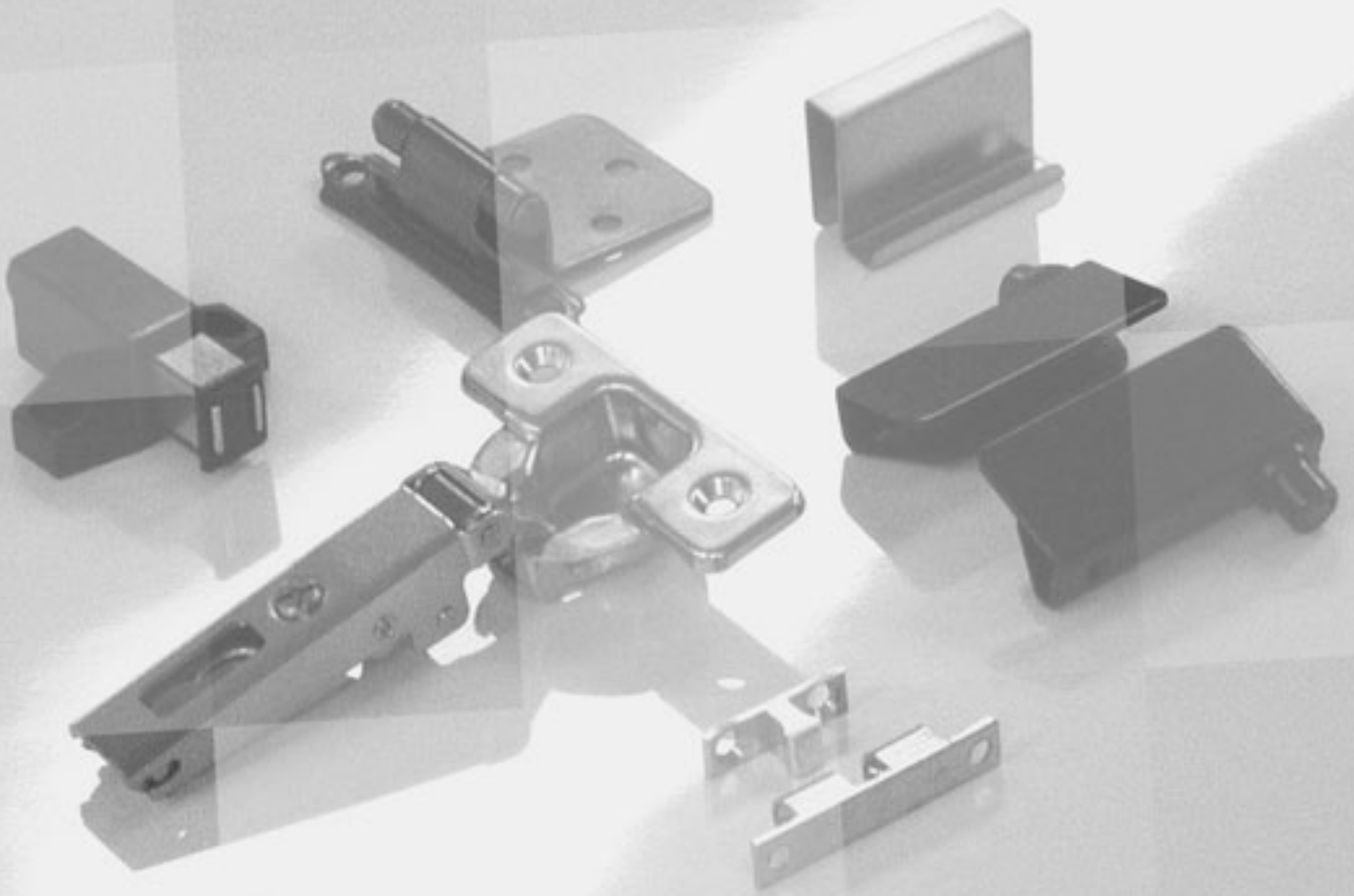

Qline

PENTURES MINI ET PLAQUES DEMONTAGE
MINI HINGES AND MOUNTING PLATES

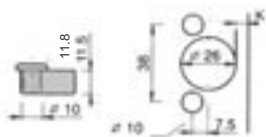

- A VISSER
SCREW-IN
- A ENFONCER
KNOCK-IN
- VIS EURO
EURO - SCREWS
- F/S
- SANS RESSORT
FREE SWINGING
- S/C
- AVEC RESSORT
SELF-CLOSING



PLEIN RECOUVREMENT / FULL OVERLAY

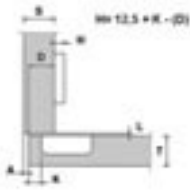

# QUINKO-TEK	OUVERTURE OPENING	CAISSE CASE
405A - ES	95°	500
403A - NC	95°	500
405A - NC	95°	500
402A - NC	95°	500
404A - NC	95°	500
404A - ES	95°	500



DEMI RECOUVREMENT / HALF OVERLAY

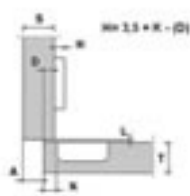

405B - ES	95°	500
403B - NC	95°	500
405B - NC	95°	500
402B - NC	95°	500
404B - NC	95°	500
404B - ES	95°	500



INTÉRIEUR / INSET

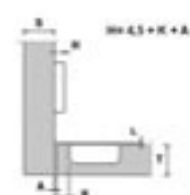

405C - ES	95°	500
403C - NC	95°	500
405C - NC	95°	500
402C - NC	95°	500
404C - NC	95°	500
404C - ES	95°	500



PLEIN RECOUVREMENT / FULL OVERLAY

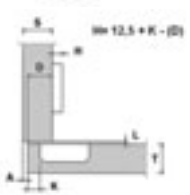

404A - ES - E0	95°	250
404A - ES - E3	95°	250



DEMI RECOUVREMENT / HALF OVERLAY

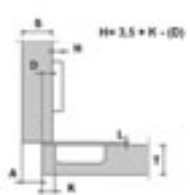

404B - ES - E0	95°	250
404B - ES - E3	95°	250



INTÉRIEUR / INSET

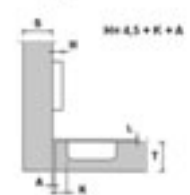

404C - ES - E0	95°	250
404C - ES - E3	95°	250

PENTURE ET PLAQUE PRÉ-ASSEMBLÉES POUR APPLICATIONS PAA HINGE AND PLATE PRE-ASSEMBLED, FOR RTA APPLICATIONS

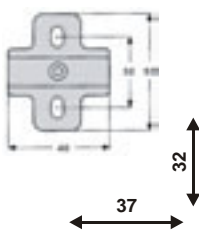

# QUINKO-TEK	HAUTEUR HEIGHT	CAISSE CASE
0410 - 00	0mm	500
0410 - 03	3mm	500
410E - 00	0mm	500
410E - 03	3mm	500

Positionnement et patron de perçage pour plaque (appliqué)
Positioning and boring pattern for plate (overlay)

Qline

PENTURES 35 MM CLIP-ON ET PLAQUES DE MONTAGE CLIP-ON 35 MM HINGES AND MOUNTING PLATES

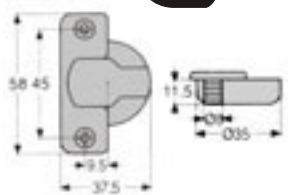
A VISSER
SCREW-INA ENFONCER
KNOCK-INVIS EURO
EURO - SCREWS

F/S

SANS RESSORT
FREE SWINGING

S/C

AVEC RESSORT
SELF-CLOSING
NOUVEAU / NEW

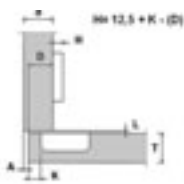

PLEIN RECOUVREMENT / FULL OVERLAY

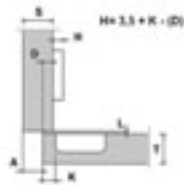

DEMI RECOUVREMENT / HALF OVERLAY

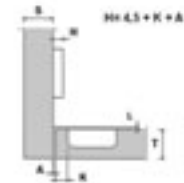

INTÉRIEUR / INSET



# QUINKO-TEK	OUVERTURE OPENING	CAISSE CASE
S/C 442A-CP-110-DA *	110°	250
S/C 440A-CP-110-DA **	110°	250
S/C 442B-CP-110-DA *	110°	250
S/C 440B-CP-110-DA **	110°	250
S/C 442C-CP-110-DA *	110°	250
S/C 440C-CP-110-DA **	110°	250

* Sans goujons / Without dowels

** Avec goujons / With dowels



PLEIN RECOUVREMENT / FULL OVERLAY

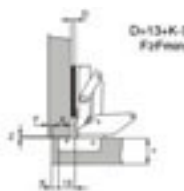

ANGLE 45° ANGLE

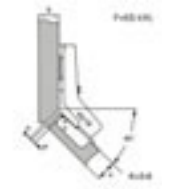

S/C 448B - CP - 170 - DA *	170°	100
S/C 446B - CP - 170 - DA **	170°	100
S/C 435A - CP - 45 - DA *	45°	100
S/C 433A - CP - 45 - DA **	45°	100

**PENTURE ET PLAQUE PRÉ-ASSEMBLÉES POUR APPLICATIONS PAA
HINGE AND PLATE PRE-ASSEMBLED, FOR RTA APPLICATIONS**

* Sans goujons / Without dowels

** Avec goujons / With dowels

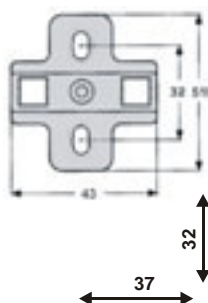

# QUINKO-TEK	HAUTEUR HEIGHT	CAISSE CASE
447A - 00	0mm	500
447A - 03	3mm	500
447A - E0	0mm	500
447A - E3	3mm	500

 Positionnement et patron de perçage pour plaque (appliqué)
 Positioning and boring pattern for plate (overlay)



SALICE 200 PENTURES HINGES

A VISSER SCREW-IN

A ENFONCER KNOCK-IN

F/S SANS RESSORT FREE SWINGING

S/C AVEC RESSORT SELF-CLOSING



PLEIN RECOUVREMENT / FULL OVERLAY

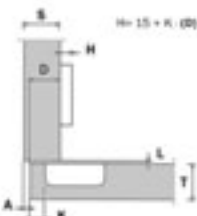

	# QUINKO-TEK	# SALICE	OUVERTURE OPENING	CAISSE CASE	PALETTE PALLET
F/S	373A - NC	C2P4A99	110°	300	7,200
F/S	371A - NC	C2R4A99	110°	300	7,200
S/C	372A - NC	C2P6A99	110°	300	7,200
S/C	370A - NC	C2R6A99	110°	300	7,200
S/C	0372 - 94	C2P7A99	94°	300	7,200
S/C	0370 - 94	C2R7A99	94°	300	7,200



DEMI RECOUVREMENT / HALF OVERLAY

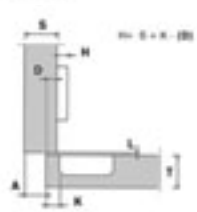

F/S	373B - NC	C2P4G99	110°	300	7,200
F/S	371B - NC	C2R4G99	110°	300	7,200
S/C	372B - NC	C2P6G99	110°	300	7,200
S/C	370B - NC	C2R6G99	110°	300	7,200



INTÉRIEUR / INSET

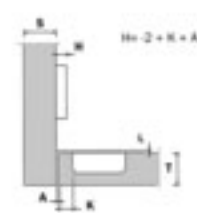

F/S	373C - NC	C2P5P99	94°	300	7,200
F/S	371C - NC	C2R5P99	94°	300	7,200
S/C	372C - NC	C2P7P99	94°	300	7,200
S/C	370C - NC	C2R7P99	94°	300	7,200



PLEIN RECOUVREMENT / FULL OVERLAY

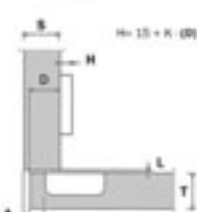

F/S	393A - NC	C2PEA99	165°	100	2400
F/S	391A - NC	C2REA99	165°	100	2400
S/C	392A - NC	C2PFA99	165°	100	2400
S/C	390A - NC	C2RFA99	165°	100	2400



DEMI RECOUVREMENT / HALF OVERLAY

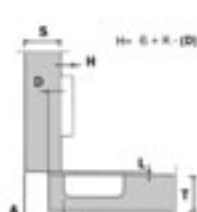

F/S	393B - NC	C2PEG99	165°	100	2400
F/S	391B - NC	C2REG99	165°	100	2400
S/C	392B - NC	C2PFG99	165°	100	2400
S/C	390B - NC	C2RFG99	165°	100	2400



INTÉRIEUR / INSET

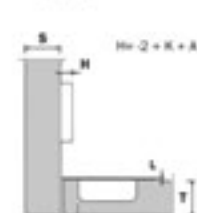

F/S	393C - NC	C2PEP99	165°	100	2400
F/S	391C - NC	C2REP99	165°	100	2400
S/C	392C - NC	C2PFP99	165°	100	2400
S/C	390C - NC	C2RFP99	165°	100	2400

PATRON DE PERÇAGE - SÉRIE 200
BORING PATTERN - SERIES 200

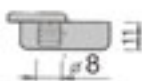
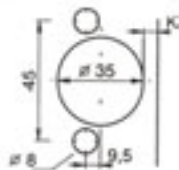

ADAPTABLE À TOUTES LES EMBASES TRADITIONNELLES SÉRIE 200 ET À TOUTES LES EMBASES **DOMI**

COMPATIBLE WITH ALL SERIES 200 TRADITIONAL MOUNTING PLATES AND WITH ALL **DOMI** MOUNTING PLATES

SALICE 200

PENTURES HINGES

A VISSER
SCREW-IN

A ENFONCER
KNOCK-IN

F/S SANS RESSORT
FREE SWINGING

S/C AVEC RESSORT
SELF-CLOSING



ANGLE NEGATIF -30°, -45° / NEGATIVE ANGLE -30°, -45°



# QUINKO-TEK	# SALICE	APPLICATION APPLICATION	CAISSE CASE	PALETTE PALLET	
S/C	358V - NC	C2P7W99	-30°	150	3,600
S/C	360V - NC	C2P7H99	-45°	150	3,600



ANGLE 45° / 45° ANGLE



S/C	380A - NC	C2P7M99AC	45°	150	3,600
S/C	378A - NC	C2R7M99AC	45°	150	3,600
S/C	380M - NC	C2P7M99	45°	150	3,600



ANGLE 30° / 30° ANGLE

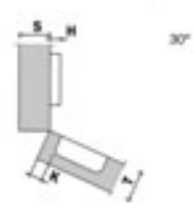

S/C	379A - NC	C2P7E99	30°	150	3,600
F/S	0379 - SR	C2P5E99	30°	150	3,600
S/C	379B - NC	C2P7T99	30°	150	3,600

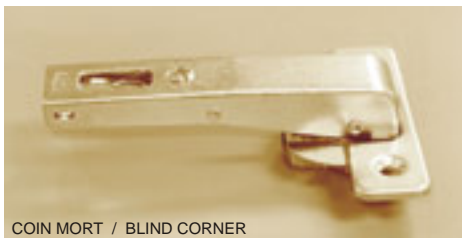

COIN MORT / BLIND CORNER

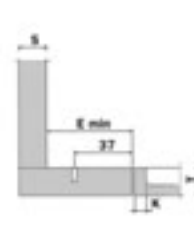

S/C	396A - NC	C2P7N99AC	94°	150	3,600
S/C	394A - NC	C2R7N99AC	94° ouverture opening	150	3,600

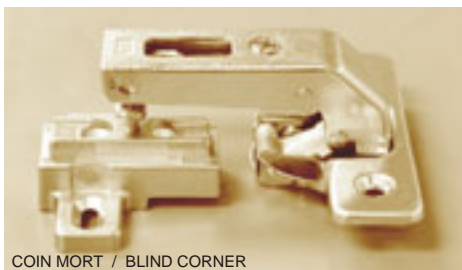

COIN MORT / BLIND CORNER

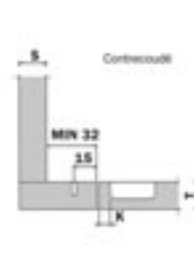

S/C	396A - BC	C2P7N99	94°	150	3,600
S/C	394A - BC	C2R7N99	94° ouverture opening	150	3,600
Plaque de montage / Mounting plate					
	397A - 09 plaque / plate 28 x 32mm	B2S3B99B6	9mm épaisseur thickness	300	7,200



LAZY SUZAN

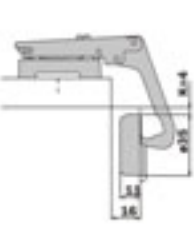

S/C	359Y - NC	C2PYA99	90° LAZY SUZAN	150	3,600
-----	-----------	---------	-------------------	-----	-------

PATRON DE PERÇAGE - SÉRIE 200 BORING PATTERN - SERIES 200

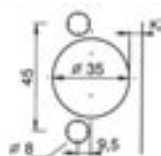

ADAPTABLE À TOUTES LES EMBASES TRADITIONNELLES SÉRIE 200 ET À TOUTES LES EMBASES **DOMI**

COMPATIBLE WITH ALL SERIES 200 TRADITIONAL MOUNTING PLATES AND WITH ALL **DOMI** MOUNTING PLATES



SALICE 200

PENTURES LOGICA LOGICA HINGES



A VISSER
SCREW-IN



LOGICA
LOGICA

F/S

SANS RESSORT
FREE SWINGING

S/C

AVEC RESSORT
SELF-CLOSING



PLEIN RECOUVREMENT / FULL OVERLAY

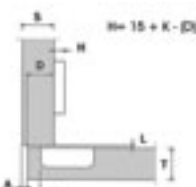

# QUINKO-TEK	# SALICE	OUVERTURE OPENING	CAISSE CASE	PALETTE PALLET
370A - LG	C2J6A99	110°	300	7,200



DEMI RECOUVREMENT / HALF OVERLAY

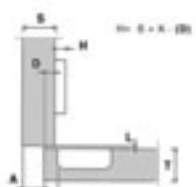

370B - LG	C2J6G99	110°	300	7,200
-----------	---------	------	-----	-------



INTERIEUR / INSET

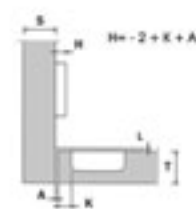

370C - LG	C2J7P99	94°	300	7,200
-----------	---------	-----	-----	-------

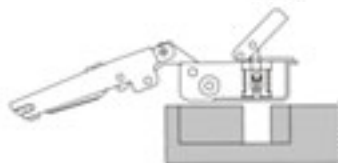
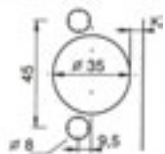

INSTALLATION RAPIDE / FAST INSTALLATION



SALICE

PLAQUES DE MONTAGE LOGICA LOGICA MOUNTING PLATES

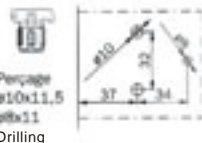

398GL - 00	B7R9P09D	0mm	300	7,200
398GL - 03	B7R9P39D	3mm épaisseur thickness	300	7,200

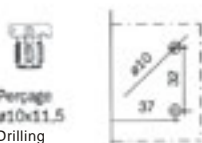

395AL - 00	B7R9E09	0mm	300	7,200
395AL - 03	B7R9E39	3mm épaisseur thickness	300	7,200

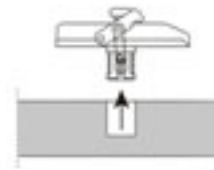
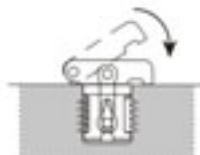
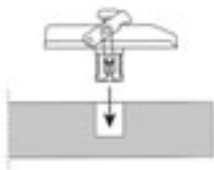

SALICE
**INFORMATIONS
INFORMATION**

 Largeur de la porte jusqu'à 600 mm / 2ft
 Door width up to 600mm / 2ft

 Nombre de charnières requises par porte
 Poids maximum de la porte

∅ 26 mm	10 lb	15 lb	20 lb
∅ 35 mm	20 lb	40 lb	60 lb

 Nombre de charnières
 2 3 4

 Recommended number of hinges per door
 Maximum door weight

∅ 26 mm	10 lb	15 lb	20 lb
∅ 35 mm	20 lb	40 lb	60 lb

No. of hinges 2 3 4

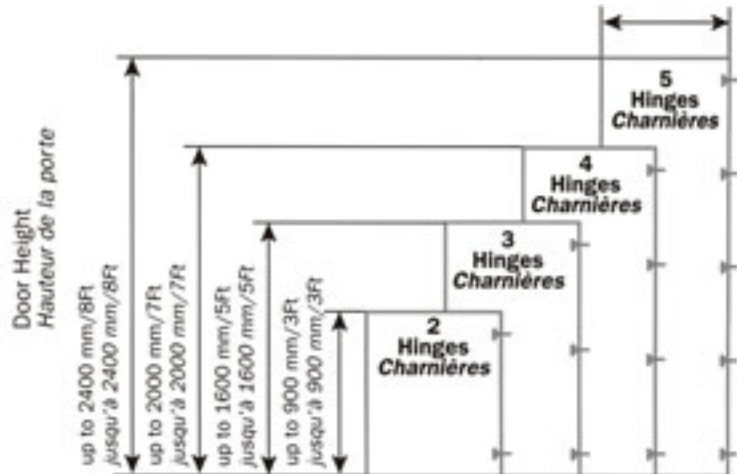
SALICE
**RÉGLAGE LATÉRAL PARALLÈLE ET AJUSTEMENT
PARALLEL AND COMPENSATING SIDE ADJUSTMENT**
Réglage latéral de la porte avec des charnières Série 200 et F

Une technique spéciale de réglage latéral permet un déplacement de la porte en maintenant la même valeur "L" de 0.7 mm.

Réglage latéral compensé. C'est une exclusivité sur toutes les charnières Salice série 200 et F

Side to side adjustment of the door with Series 200 and F hinges

An ingenious adjustment system allows the door to be moved sideways without changing the gap behind the door (the "L" value of 0.7 mm remains constant).

Compensating side adjustment. A patented system exclusive to all Salice 200 and F series hinges.

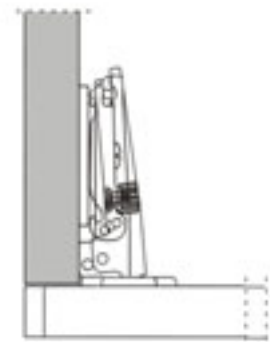
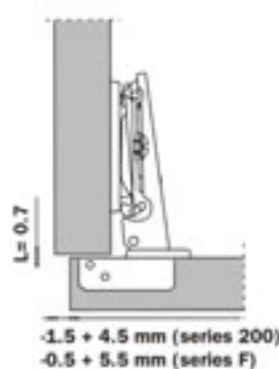
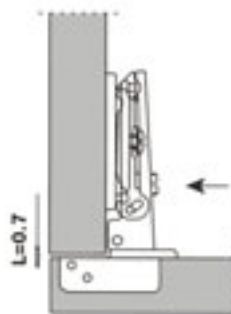
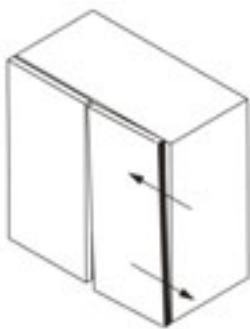

La vis de réglage agit en faisant avancer le bras de la charnière.

La porte se déplace par rapport au côté en évitant tout détachement. Des opérations d'ajustage, par la suite, ne sont plus nécessaires.

The adjustment screw operates in conjunction with the inner leaf of the hinge arm.

The door moves in only one direction - parallel to the carcass and without a gap developing between the door and the carcass. No further adjustments are necessary. There is no gap to reduce.



SALICE 600

PENTURES MINI MINI HINGES

A VISSER
SCREW-IN

A ENFONCER
KNOCK-IN

F/S SANS RESSORT
FREE SWINGING

S/C AVEC RESSORT
SELF-CLOSING



PLEIN RECOUVREMENT / FULL OVERLAY

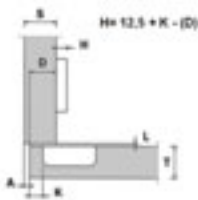

# QUINKO-TEK	# SALICE	OUVERTURE OPENING	CAISSE CASE	PALETTE PALLET	
F/S	353A - NC	C6A5C99	94°	600	14,400
F/S	351A - NC	C6B5C99	94°	600	14,400
S/C	352A - NC	C6A7C99	94°	600	14,400
S/C	350A - NC	C6B7C99	94°	600	14,400

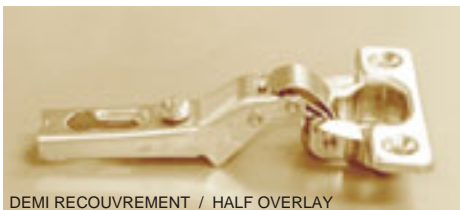

DEMI RECOUVREMENT / HALF OVERLAY

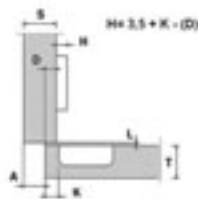

F/S	353B - NC	C6A5L99	94°	600	14,400
F/S	351B - NC	C6B5L99	94°	600	14,400
S/C	352B - NC	C6A7L99	94°	600	14,400
S/C	350B - NC	C6B7L99	94°	600	14,400



INTÉRIEUR / INSET

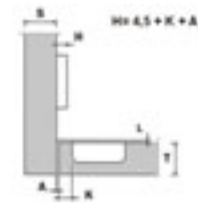

F/S	353C - NC	C6A5S99	94°	600	14,400
F/S	351C - NC	C6B5S99	94°	600	14,400
S/C	352C - NC	C6A7S99	94°	600	14,400
S/C	350C - NC	C6B7S99	94°	600	14,400



ANGLE 45° / 45° ANGLE

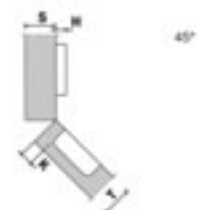

S/C	352D - NC	C6A7M99	94°	300	7,200
-----	-----------	---------	-----	-----	-------

**PATRON DE PERÇAGE - SÉRIE 600
BORING PATTERN - SERIE 600**

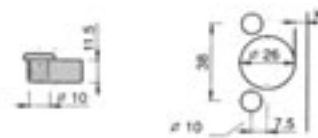

SALICE

CHARNIÈRES FACE FRAME FACE FRAME HINGES



**PATRON DE PERÇAGE
BORING PATTERN**

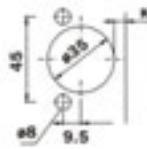

RECOUVREMENT
OVERLAY

1/2"

S/C	363A - NC	CSR3799	106°	300	7,200
S/C	365A - NC	CSP3799	106°	300	7,200

9/16"

S/C	363B - NC	CSR3699	106°	300	7,200
S/C	365B - NC	CSP3699	106°	300	7,200

5/8"

S/C	363C - NC	CSR3599	106°	300	7,200
S/C	365C - NC	CSP3599	106°	300	7,200

3/4"

S/C	363D - NC	CSR3499	106°	300	7,200
S/C	365D - NC	CSP3499	106°	300	7,200

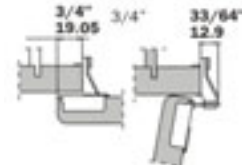
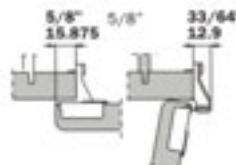
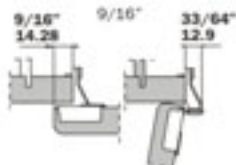
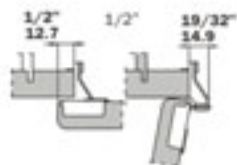

SALICE 200

PENTURES POUR PORTES EN VITRE MINI HINGES FOR GLASS DOORS



S/C AVEC RESSORT
SELF-CLOSING



PLEIN RECOUVREMENT / FULL OVERLAY

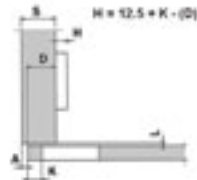

DEMI RECOUVREMENT / HALF OVERLAY

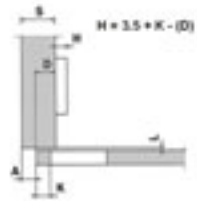

INTÉRIEUR / INSET

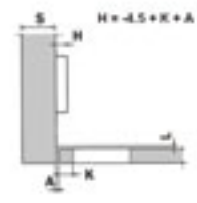

ANGLE 45° / 45° ANGLE

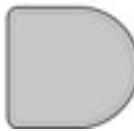
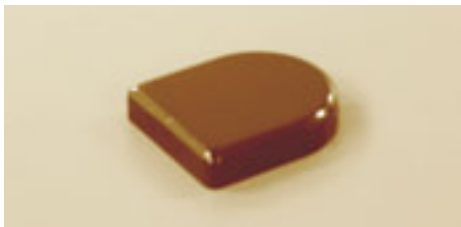
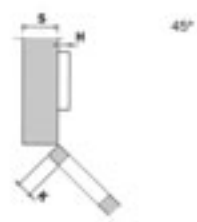

# QUINKO-TEK	# SALICE	OUVERTURE OPENING	CAISSE CASE	PALETTE PALLET
S/C 355A - NC	C2C7A39	94°	150	3,600
S/C 355B - NC	C2C7G39	94°	150	3,600
S/C 355C - NC	C2C7P39	94°	150	3,600
S/C 355D - NC	C2C7M39	94°	150	3,600
356R - BL	P2CTAX1	BLANC WHITE	300	-
356R - NR	P2CTAX3	NOIRE BLACK	300	-
356R - CH	P2CTA06	CHROME CHROME	300	-
356R - LT	P2CTA08	LAITON BRASS	300	-
356D - BL	P2CBAX1	BLANC WHITE	300	-
356D - NR	P2CBAX3	NOIRE BLACK	300	-
356D - CH	P2CBA06	CHROME CHROME	300	-
356D - LT	P2CBA08	LAITON BRASS	300	-

**PATRON DE PERÇAGE
BORING PATTERN**

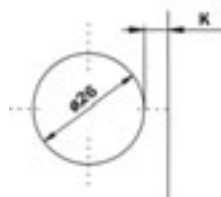

- POSSIBILITÉ DE PERÇAGE DE LA PORTE (K) DE 5,5 À 6,5mm
- UTILISER UNE VITRE D'UNE ÉPAISSEUR DE 4 À 6mm
- ADAPTABLE À TOUTES LES EMBASES TRADITIONNELLES SÉRIE 200, ET À TOUTES LES EMBASES **DOMI**
- RANGE OF DRILLING DISTANCE ON THE DOORS (K) FROM 5.5 TO 6.5mm
- FOR USE WITH GLASS OF 4mm TO 6mm THICKNESS
- COMPATIBLE WITH ALL SERIES 200 TRADITIONAL MOUNTING PLATES AND WITH ALL **DOMI** MOUNTING PLATES



SALICE F

PENTURES HINGES

A VISSER SCREW-IN

A ENFONCER KNOCK-IN

F/S SANS RESSORT FREE SWINGING

S/C AVEC RESSORT SELF-CLOSING



PLEIN RECOUVREMENT / FULL OVERLAY

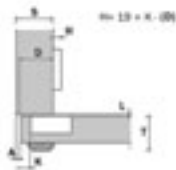

DEMI RECOUVREMENT / HALF OVERLAY

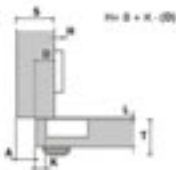

INTÉRIEUR / INSET

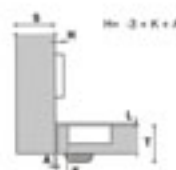

# QUINKO-TEK	# SALICE	OUVERTURE OPENING	CAISSE CASE	PALETTE PALLET	
S/C	368A - NC	CFA7A99	94°	300	7,200
F/S	369A - NC	CFA5A99	94°	300	7,200
S/C	368B - NC	CFA7G99	94°	300	7,200
F/S	369B - NC	CFA5G99	94°	300	7,200
S/C	368C - NC	CFA7P99	94°	300	7,200
F/S	369C - NC	CFA5P99	94°	300	7,200

POUR PORTES ÉPAISSES JUSQU'À 1 1/2" ET APPLICATIONS SPÉCIALES
FOR DOORS UP TO 1 1/2" THICK AND OTHER SPECIAL APPLICATIONS

SALICE 800

PENTURES CLIP ÉCONOMIQUES ECONOMICAL CLIP HINGES



PLEIN RECOUVREMENT / FULL OVERLAY

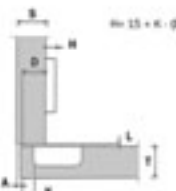

DEMI RECOUVREMENT / HALF OVERLAY

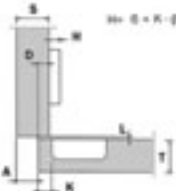

INTÉRIEUR / INSET

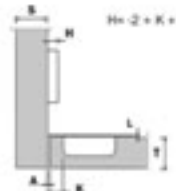

S/C	376A - NC	C8P6C99	110°	300	7,200
S/C	374A - NC	C8R6C99	110°	300	7,200
S/C	376B - NC	C8P6L99	110°	300	7,200
S/C	374B - NC	C8R6L99	110°	300	7,200
S/C	376C - NC	C8P7S99	94°	300	7,200
S/C	374C - NC	C8R7S99	94°	300	7,200

ADAPTABLE SEULEMENT SUR PLAQUE DE MONTAGE 397
ONLY COMPATIBLE WITH 397 MOUNTING PLATE

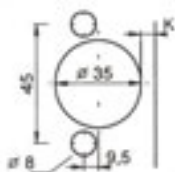

PATRON DE PERÇAGE - SÉRIE 800
BORING PATTERN - SERIES 800

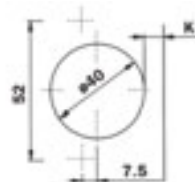



PATRON DE PERÇAGE - SÉRIE F
BORING PATTERN - SERIES F













SALICE

PLAQUES DE MONTAGE SALICE POUR SERIES 200, 600, 800 ET F SALICE MOUNTING PLATES FOR 200, 600, 800 AND F SERIES

 A VISSER
SCREW-IN

 VIS EURO
EURO - SCREWS





# QUINKO-TEK	# SALICE	HAUTEUR HEIGHT	CAISSE CASE	PALETTE PALLET	MATERIEL MATERIAL
 0397 - 00	B2V3H09	0 mm	600	14,400	ACIER - STEEL
 0397 - 02	B2V3H29	2 mm	600	14,400	ACIER - STEEL
 0397 - 03	B2V3H39	3 mm	600	14,400	ACIER - STEEL
 0397 - 06	B2V3H69	6 mm	600	14,400	ACIER - STEEL
 397X - 09	B2V3H99	9 mm	600	14,400	ACIER - STEEL
 397X - 12	B2V3BC9	12 mm	600	14,400	ACIER - STEEL
 0397 - N2	B2VGHS9	-2 mm	600	14,400	ACIER - STEEL
 397E - 00	B2VGH09	0 mm	600	14,400	ACIER - STEEL
 397E - 03	B2VGH39	3 mm	600	14,400	ACIER - STEEL
 397E - 06	B2VGH69	6 mm	600	14,400	ACIER - STEEL
 397E - 09	B2VGH99	9 mm	600	14,400	ACIER - STEEL



LA FAMEUSE PLAQUE SYMETRIQUE DE SALICE, PEUT ÊTRE MONTÉE SUR LA PENTURE D'UN SENS COMME DE L'AUTRE A 37MM DU BORD AU CENTRE DES TROUS POUR TOUTE PORTE EXTERIEURE.

THE FAMOUS SALICE SYMMETRIC CROSSPLATE, CAN BE MOUNTED ON A HINGE FROM EITHER SIDE, 37MM FROM EDGE TO HOLE CENTER. FOR ALL OVERLAY DOOR APPLICATIONS







 395A - 00	B2R3E09	0 mm	600	14,400	ZAMAC-DIE CAST
 395A - 03	B2R3E39	3 mm	600	14,400	ZAMAC-DIE CAST
 395A - 06	B2R3E69	6 mm	600	14,400	ZAMAC-DIE CAST



 0363 - 00	BAV3L09F	0 mm	300	7,200	ACIER-STEEL
 0363 - 03	BAV3L39F	3 mm	300	7,200	ACIER-STEEL
 0363 - 06	BAV3L69F	6 mm	300	7,200	ACIER-STEEL
 363E - 00	BAVGL09F	0 mm	300	7,200	ACIER-STEEL
 363E - 03	BAVGL39F	3 mm	300	7,200	ACIER-STEEL



 398G - 00	BAR3P09	0 mm	300	7,200	ZAMAC-DIE CAST
 398G - 03	BAR3P39	3 mm	300	7,200	ZAMAC-DIE CAST
 398G - 06	BAR3P69	6 mm	300	7,200	ZAMAC-DIE CAST
 398E - 00	BARGP09	0 mm	300	7,200	ZAMAC-DIE CAST
 398E - 03	BARGP39	3 mm	300	7,200	ZAMAC-DIE CAST





 0399 - 00	B2U3B19	1 mm	600	14,400	ZAMAC-DIE CAST
 399C - 00	BAU3L19	1 mm	300	7,200	ACIER-STEEL









SALICE PLAQUES DE MONTAGE À ANGLES VARIABLES ET ACCESSOIRES

MOUNTING PLATES FOR VARIABLE ANGLES AND OTHER ACCESSORIES

 A VISSER
 SCREW-IN

 VIS EURO
 EURO - SCREWS

# QUINKO-TEK	# SALICE	ANGLE ANGLE	CAISSE CASE	PALETTE PALLET
 395P - XX	B2V3BW9R	+7,5° -7,5°	600	14,400
 395PE - XX	B2VGBW9R	+7,5° -7,5°	600	14,400
 395X - 30	B2V3BW9S	+30° +10°	300	7,200
 395XE - 30	B2VGBW9S	+30° +10°	300	7,200
 395X - 15	B2V3BW9	15°	600	14,400
 395XE - 15	B2VGBW9	15°	600	14,400
26mm 357S - 26	S6A786XG	épaisseur thickness 1,5mm	1000	-
35mm 357S - 35	S2A786XG	1,4mm	1000	-
40mm 357S - 40	SFA586XG	1,5mm	1000	-
UTILISER POUR REDUIRE LA PROFONDEUR DE PERÇAGE TO BE USED TO REDUCE THE CUP DRILLING DEPTH				
357L - NR	S2AF37X3	-	1000	-
ARRÊT POUR LIMITER L'OUVERTURE À 125° POUR LES CHARNIÈRES À 165° STOP DEVICE FOR 165° HINGES. LIMITS THE OPENING TO 125°				
356SCC - NC	S2XX83H9	-	1000	-
CACHE VIS SYMÉTRIQUE EN ACIER AVEC LOGO IMPRIMÉ POUR TOUTES LES CHARNIÈRES SERIE 200 ET F STEEL SYMMETRICAL SCREW COVER CAP WITH PRINTED LOGO FOR ALL SERIES 200 AND F HINGES				
356FCC - NC	S2BX83H9	-	-	-
CACHE FLASQUE HAUTEUR 3,8mm EN ACIER NICKELÉ POUR CHARNIÈRES AVEC FIXATION À VISSER ET A PRESSION FLANGE COVER CAP 3,8mm HEIGHT. NICKEL PLATED STEEL SUITABLE FOR SCREW-ON AND KNOCK-IN HINGES				

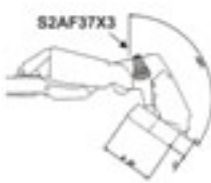

 CALE POUR CHARNIÈRE
 SPACER FOR HINGE

SALICE

SMOVE AMORTISSEURS DE PORTE ET TIROIR
SMOVE SHOCK ABSORBER FOR DOOR AND DRAWER

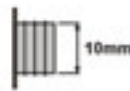

# QUINKO-TEK	# SALICE	COULEUR COLOR	BOÎTE BOX	CAISSE CASE
D00ISN SMOVE	D00ISN	-	300	2,400



D020SNB Bague couvre-trou Grommet	D020XX1	BLANC WHITE	600	7,200
---	---------	-------------	-----	-------

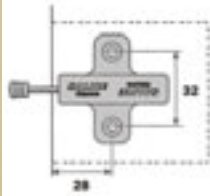

D060SNB	D060SN1	BLANC WHITE	600	14,400 palette pallet
ADAPTEUR POUR PORTES INTERNES, TIROIRS ET APPLICATIONS SPÉCIALES ADAPTER FOR INSET DOORS, DRAWERS AND SPECIAL APPLICATIONS				

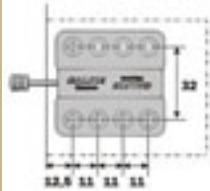

D061SNB	D060SN1	BLANC WHITE	600	14,400 palette pallet
ADAPTEUR POUR PORTES INTERNES, TIROIRS ET APPLICATIONS SPÉCIALES ADAPTER FOR INSET DOORS, DRAWERS AND SPECIAL APPLICATIONS				

DISTANCE D'APPLICATION DU SMOVE
SMOVE RANGE OF INSTALLATION POSITIONS

POUR LE POSITIONNEMENT DE SMOVE IL EST CONSEILLÉ DE RESPECTER LES TOLÉRANCES CI-DESSOUS; EN CHOISSANT LE MINIMUM DE LA TOLÉRANCE ON AURA UN EFFET MOINS FREINANT DE LA PORTE. AU MAXIMUM DE LA TOLÉRANCE ON AURA UN EFFET PLUS FREINANT.



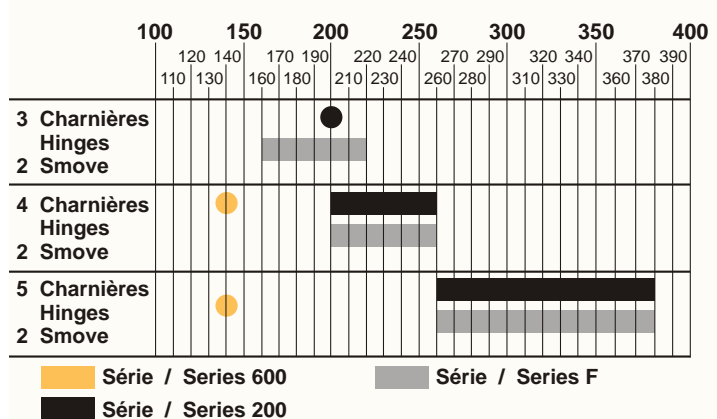
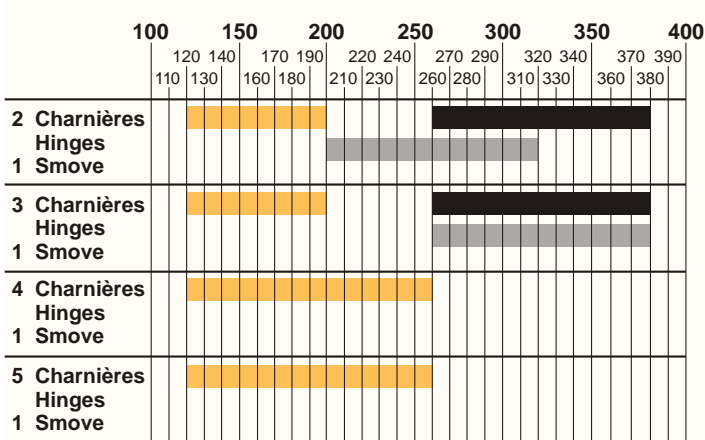

IT IS SUGGESTED THAT SMOVE IS POSITIONED WITHIN THE STATED RANGES; AT THE MINIMUM DISTANCE, THE BRAKING EFFECT OF THE DOOR WILL BE WEAKER. AT THE MAXIMUM DISTANCE, THE BRAKING EFFECT WILL BE STRONGER.



SALICE

SALICE CONCERTINA CONCERTINA SYSTEM



	# QUINKO-TEK	# SALICE	FINISH FINI	CAISSE CASE
	410Z - OH	F1C169	ZINC / ZINC	25
Charnière supérieure / Upper hinges				
	411Z - CC	F1CXE9	ZINC / ZINC	25
Charnière centrale / Central hinges				
	4128 - CR	F1PXAY	BLANC / WHITE	25
Charriot / Sliding block				
	408B - GD	F1GFA1	BLANC / WHITE	25
	408N - GD	F1GFA3 1.180 m	NOIR / BLACK	25
Glissière / Track				
	409B - JP	F1SBA1	BLANC / WHITE	METRE / METER
	409N - JP	F1SBA3	NOIR / BLACK	METRE / METER
	409C - JP	F1SBAY	NEUTRE / NEUTRAL	METRE / METER
Joint souple de protection / Finger protection strip				



SALICE Practical

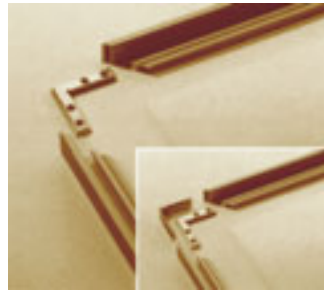

Nouveau système de porte vitrée à l'Européenne. Vous coupez et assemblez selon vos besoins et dimensions. Profilé du cadre en aluminium disponible en longueur de 10'. Renforcé par des équerres à 4 vis. Éléments cache-profil internes en plastique. Montage facile et rapide avec la charnière adaptable sur toute sa longueur.

New European glass door system. You may cut to match your dimensions. Aluminum frame profile available in 10' lengths. Reinforced corner connector with 4 fixing screws. Elegant internal cover frame profile made of moulded plastic. Easy and fast mounting with adaptable hinges along the entire length.

Accessoires pour l'assemblage des cadres / Accessories for frame assembly



Équerre supplémentaire en acier pour assemblage du cadre / Additional corner connector for the frame assembly

Caisse / Case : 600

407E - SP



Profilé métallique pour portes, glaces à encastrer, barre de 3 m / Frame for doors, glass to be inserted, 3 m lengths

Caisse / Case : 12

407AL - PM



Équerre avec 4 vis de fixation pour l'assemblage du cadre / Corner connector with 4 fixing screws for the frame assembly

Caisse / Case : 600

407E - 4V



Garniture pour glaces, barres de 3 m / Gasket for glass, 3 m lengths

Caisse / Case : 12

407B - GG



Équerre avec 2 vis de fixation pour l'assemblage du cadre / Corner connector with 2 fixing screws for the frame assembly

Caisse / Case : 600.

407E - 2V

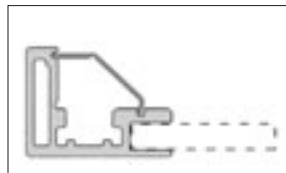

Cache-profil interne en plastique galbe, barre de 3 m / Internal cover frame profile of flat plastic, 3 m lengths

Caisse / Case : 120

407P - CI



407A - NC

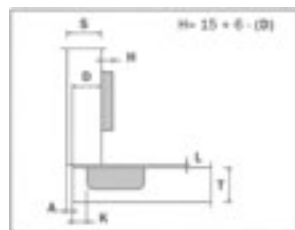

407B - NC

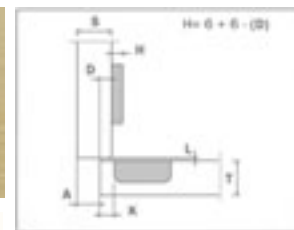

407C - NC

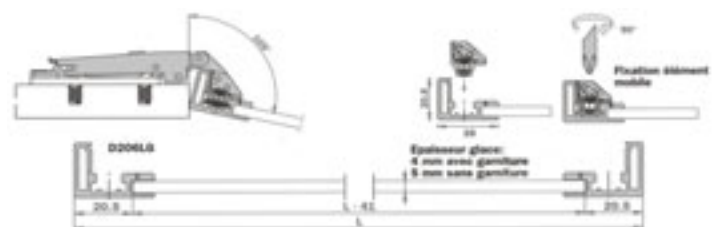
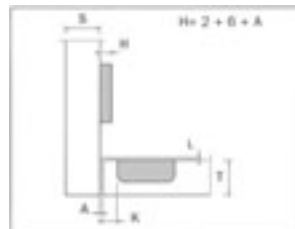

SALICE SYSTEMES DE PORTES RELEVABLES / SWING DOOR SYSTEMS

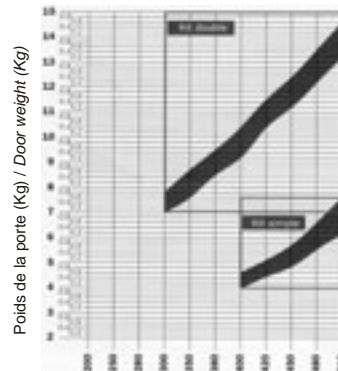

Système pour portes en bois / Wood door system

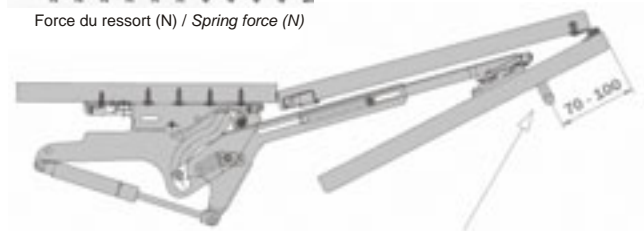

Accessoires pour assemblage des portes / Accessories for door assembly



416SL - XXXX

416SL - XXXX =

- 416SL - 200N
- 416SL - 250N
- 416SL - 280N
- 416SL - 300N
- 416SL - 350N
- 416SL - 380N
- 416SL - 400N
- 416SL - 420N
- 416SL - 450N
- 416SL - 480N
- 416SL - 510N



1



3

417N - CC

Charnière centrale symétrique / Symmetrical central hinge

Caisse / Case : 600



4

398I - E2

Embase supérieure et latérale / Upper and lateral mounting plate

Caisse / Case : 300



Système de levée / Gaz lifting system

Carton / Box : 10 sets

Cette embase est un élément indispensable. Elle garantit le fonctionnement du système / This mounting plate is indispensable. It guarantees the well functioning of the system.



2

372A - NC

Charnière supérieure / Upper hinge

Caisse / Case : 300

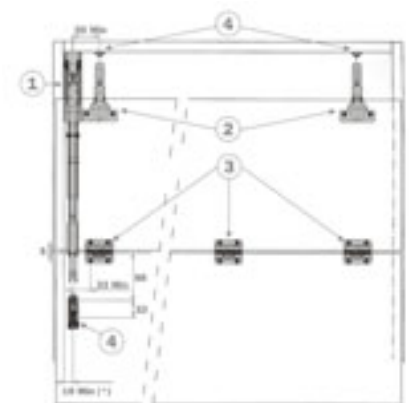
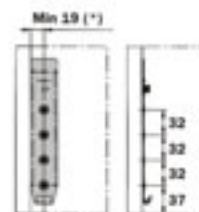

SALICE *PracticAL*

**SYSTÈME POUR PORTES RELEVABLES
SWING DOOR SYSTEMS**

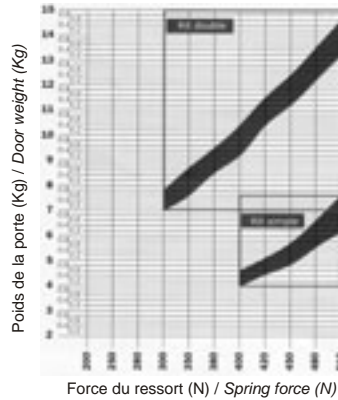

Systèmes pour portes
PracticAL
Door systems



416SL - XXXX



407A - NC



419Z - CC

416SL - XXXX =

- 416SL - 200N
- 416SL - 250N
- 416SL - 280N
- 416SL - 300N
- 416SL - 350N
- 416SL - 380N
- 416SL - 400N
- 416SL - 420N
- 416SL - 450N
- 416SL - 480N
- 416SL - 510N

Système de levée /
Gaz lifting system

Carton / Box : 10 sets

Charnière supérieure pour
Système PracticAL /
Upper hinge for
PracticAL system

Caisse / Case : 150

Charnière centrale symétrique
avec adaptateurs /
Symmetrical central hinge
with adapters

Caisse / Case : 150



398I - 02

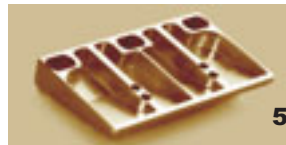

398I - SE



398I - E2

Embase latérale /
Lateral mounting plate

Caisse / Case : 300

Support pour l'embase /
Support for mounting plate

Caisse / Case : 150

Embase supérieure /
Superior mounting plate

Caisse / Case : 300

Cette embase est un élément indispensable. Elle garantit le fonctionnement du système / This mounting plate base is indispensable. It guarantees the proper functioning of the system.

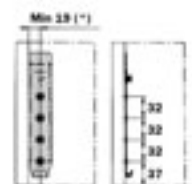
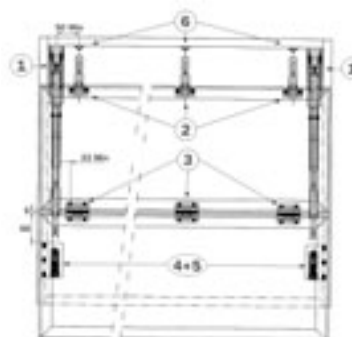



**PENTURES BASIC
BASIC HINGES**

A VISSER
SCREW-IN

A ENFONCER
KNOCK-IN

VIS EURO
EURO - SCREWS

F/S SANS RESSORT
FREE SWINGING

S/C AVEC RESSORT
SELF-CLOSING



PLEIN RECOUVREMENT / FULL OVERLAY



DEMI RECOUVREMENT / HALF OVERLAY



INTÉRIEUR / INSET



PLEIN RECOUVREMENT / FULL OVERLAY



ANGLE 45° / 45° ANGLE



COIN MORT / BLIND CORNER

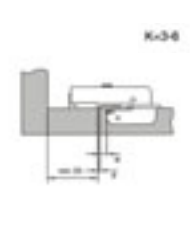
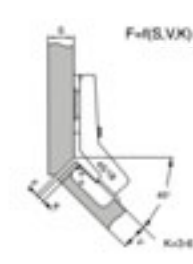
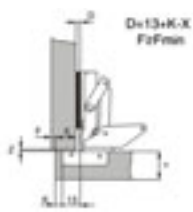
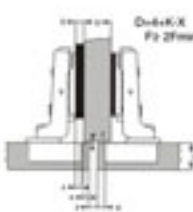
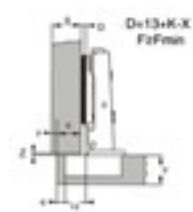

# QUINKO-TEK	# LAMA	OUVERTURE OPENING	CAISSE CASE	PALETTE PALLET
S/C 340A - NC	248.0G79.05	110°	200	6,000
F/S 341A - NC	248.0K89.05	110°	200	6,000
S/C 342A - NC	248.0G54.05	110°	200	6,000
F/S 343A - NC	248.0K88.05	110°	200	6,000
S/C 340B - NC	248.0G80.05	110°	200	6,000
F/S 341B - NC	248.0K90.05	110°	200	6,000
S/C 342B - NC	248.0G55.05	110°	200	6,000
F/S 343B - NC	248.0K85.05	110°	200	6,000
S/C 340C - NC	248.0G81.05	110°	200	6,000
F/S 341C - NC	248.0K93.05	110°	200	6,000
S/C 342C - NC	248.0G56.05	110°	200	6,000
F/S 343C - NC	248.0K94.05	110°	200	6,000
S/C 336A - NC	248.0L31.05	170°	100	3,000
S/C 338A - NC	248.0L30.05	170°	100	3,000
S/C 333A - NC	248.0L46.05	45°	100	6,000
S/C 335A - NC	248.0L33.05	45°	100	6,000
S/C 332A - NC	248.0G82.05	30°	100	6,000
S/C 334A - NC	248.0G57.05	30° application application	100	6,000
S/C 346A - NC	248.0G83.05	95°	200	6,000
S/C 348A - NC	248.0G58.05	95°	200	6,000
0345 - 03	244.0810.65	3mm	200	6,000
345E - 03	244.0C32.65	3mm épaisseur thickness	200	6,000

**PATRON DE PERÇAGE
BORING PATTERN**

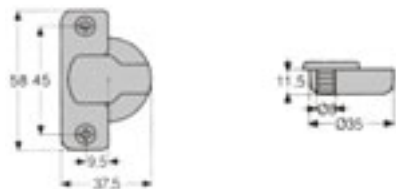

ADAPTABLE SEULEMENT AVEC EMBASES NUMERO 344
COMPATIBLE ONLY WITH NUMBER 344 MOUNTING PLATES



**PENTURES "CLIP"
"CLIP" HINGES**



A VISSER
SCREW-IN

A ENFONCER
KNOCK-IN

EASY-FIX
EASY-FIX

F/S SANS RESSORT
FREE SWINGING

S/C AVEC RESSORT
SELF-CLOSING



PLEIN RECOUVREMENT / FULL OVERLAY

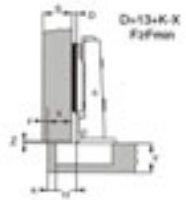

# QUINKO-TEK	# LAMA	OUVERTURE OPENING	CAISSE CASE	PALETTE PALLET
340A - CP	248.0171.05	110°	200	6,000
341A - CP	248.0009.05	110°	200	6,000
342A - CP	248.0535.05	110°	200	6,000
340A - EF	248.0186.05	110°	200	6,000



DEMI RECOUVREMENT / HALF OVERLAY

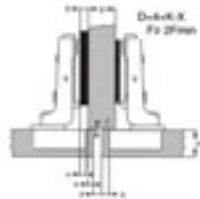

340B - CP	248.0279.05	110°	200	6,000
342B - CP	248.0536.05	110°	200	6,000
340B - EF	248.0482.05	110°	200	6,000

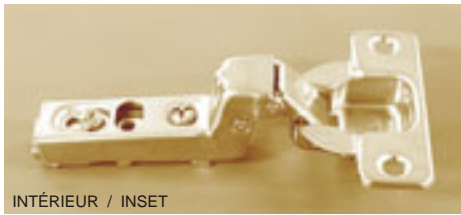

INTÉRIEUR / INSET

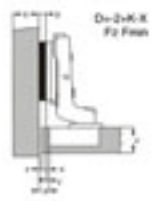

340C - CP	248.0280.05	110°	200	6,000
341C - CP	248.0011.05	110°	200	6,000
342C - CP	248.0537.05	110°	200	6,000
340C - EF	248.0487.05	110°	200	6,000



PLEIN RECOUVREMENT / FULL OVERLAY

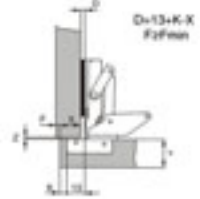

337A - CP	248.0M73.05	170°	100	3,000
339A - CP	248.0R14.05	170°	100	3,000
336A - EF	248.0N34.05	170°	100	3,000



ANGLE 45° / 45° ANGLE

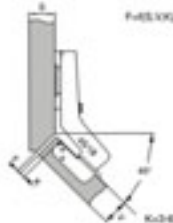

333A - CP	248.0N20.05	45°	200	6,000
335A - CP	248.0285.05	45°	200	6,000
335A - EF	248.0P21.05	45° application	200	6,000



PAA / RTA

PLEIN RECOUVREMENT / FULL OVERLAY

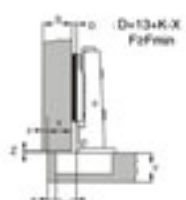

2 x 340A - EF	243.0186.05	110°	-	-
2 x 347E - 00	244.0118.05	0mm	-	-
= B340A - EFO	-	-	100	6,000

DEUX PENTURES ET DEUX PLAQUES PRÉ-ASSEMBLÉES DANS UN SAC, POUR APPLICATIONS PAA

TWO HINGES AND TWO PLATES PRE-ASSEMBLED IN ONE BAG, FOR RTA APPLICATIONS

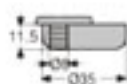
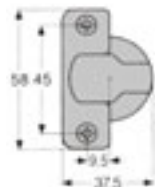

ADAPTABLE SEULEMENT AVEC EMBASES NUMERO 347
COMPATIBLE ONLY WITH NUMBER 347 MOUNTING PLATES



**PENTURES MINI
MINI HINGES**



A VISSER
SCREW-IN

A ENFONCER
KNOCK-IN

EASY-FIX
EASY-FIX

F/S SANS RESSORT
FREE SWINGING

S/C AVEC RESSORT
SELF-CLOSING



PLEIN RECOUVREMENT / FULL OVERLAY

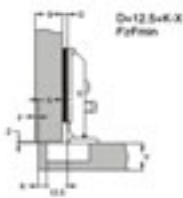

	# QUINKO-TEK	# LAMA	OUVERTURE OPENING	CAISSE CASE	PALETTE PALLET
F/S	301A - NC	243.0H23.05	95°	200	6,000
S/C	302A - NC	243.0B35.05	95°	200	6,000
S/C	302A - EF	243.0M64.05	95°	200	6,000
F/S	303A - NC	243.0L43.05	95°	200	6,000

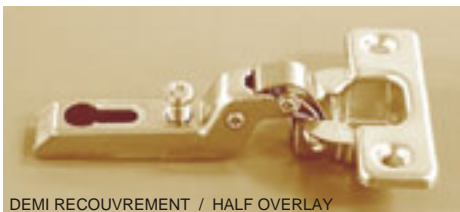

DEMI RECOUVREMENT / HALF OVERLAY

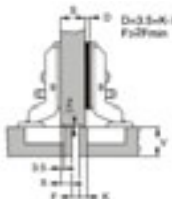

F/S	301B - NC	243.0H24.05	95°	200	6,000
S/C	302B - NC	243.0B36.05	95°	200	6,000
S/C	302B - EF	243.0M65.05	95°	200	6,000
F/S	303B - NC	243.0L44.05	95°	200	6,000



INTÉRIEUR / INSET

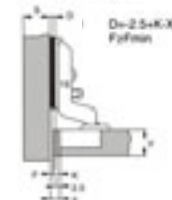

F/S	301C - NC	243.0H25.05	95°	200	6,000
S/C	302C - NC	243.0B37.05	95°	200	6,000
S/C	302C - EF	243.0M42.05	95°	200	6,000
F/S	303C - NC	243.0L45.05	95°	200	6,000



ANGLE 45° / 45° ANGLE

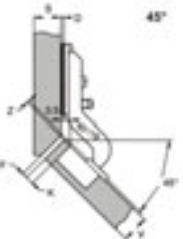

S/C	302D - NC	243.0002.05	95°	200	6,000
-----	-----------	-------------	-----	-----	-------



PAA / RTA

PLEIN RECOUVREMENT / FULL OVERLAY

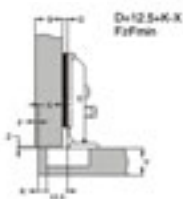

S/C	2 x 302A - EF	243.0M64.05	95°	-	-
	2 x 300E - 00	244.0846.05	0mm	-	-
	= P302A - EFO	-	-	200	6,000

DEUX PENTURES ET DEUX PLAQUES PRÉ-ASSEMBLÉES DANS UN SAC, POUR APPLICATIONS PAA
TWO HINGES AND TWO PLATES PRE-ASSEMBLED IN ONE BAG, FOR RTA APPLICATIONS

**PATRON DE PERÇAGE
BORING PATTERN**



ADAPTABLE SEULEMENT AVEC EMBASES NUMERO 300
COMPATIBLE ONLY WITH NUMBER 300 MOUNTING PLATES



**PENTURES POUR PORTE À ABATTANT
HINGES FOR FLAP DOOR**



blanc white	0346 - BL	2446.9033.83	90°	250	7,500
brun brown	0346 - BR	2446.9033.84	90°	250	7,500



PLAQUES POUR PENTURES BASIC
MOUNTING PLATES FOR BASIC HINGES



A VISSER
SCREW-IN

GOUJONS 5mm
5mm DOWELS

VIS EURO
EURO - SCREWS

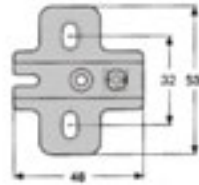

# QUINKO-TEK	# LAMA	ÉPAISSEUR THICKNESS	CAISSE CASE	PALETTE PALLET
0344 - 00	244.0L29.05	0mm	200	6,000
0344 - 03	244.0L39.05	3mm	200	6,000
0344 - 06	244.0232.65	6mm	200	6,000
344E - 00	244.0965.05	0mm	200	6,000
344E - 03	244.0G19.05	3mm	200	6,000
344E - 06	244.0914.65	6mm	200	6,000



PLAQUES POUR PENTURES CLIP
MOUNTING PLATES FOR CLIP HINGES

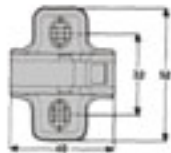

0347 - 00	244.1233.05	0mm	200	6,000
0347 - 03	244.1234.05	3mm	200	6,000
347E - 00	244.0118.05	0mm	200	6,000
347E - 03	244.0119.05	3mm	200	6,000

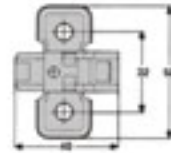

347A - 00	244.0R22.05	0mm	200	6,000
347A - 03	244.0R24.05	3mm	200	6,000



347D - 03	244.0128.05	3mm	200	6,000
-----------	-------------	-----	-----	-------

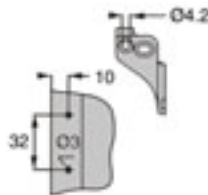
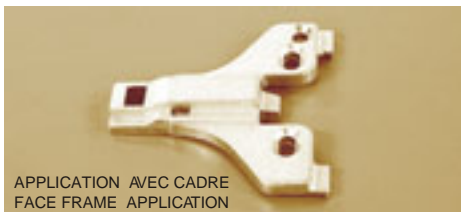

0347 - FF	244.3653.05	0mm	200	6,000
-----------	-------------	-----	-----	-------



PLAQUES POUR PENTURES MINI
MOUNTING PLATES FOR MINI HINGES

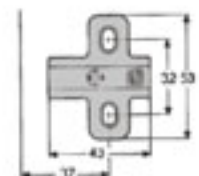

0300 - 00	244.0655.05	0mm	200	6,000
0300 - 03	244.0656.05	3mm	200	6,000
300E - 00	244.0846.05	0mm	200	6,000
300E - 03	244.0847.05	3mm	200	6,000

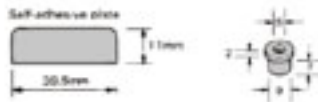
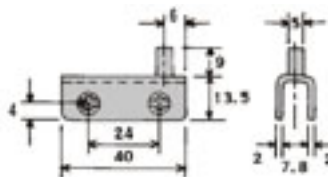
Qline
PENTURES PIVOTANTES
PIVOT HINGES

# QUINKO-TEK	FINI FINISH	CARTON CARTON	CAISSE CASE
0500 - BL	BLANC / WHITE	125	250
0500 - CH	CHROME	125	250
0500 - LT	LAITON / BRASS	125	250
0500 - NR	NOIR / BLACK	125	250

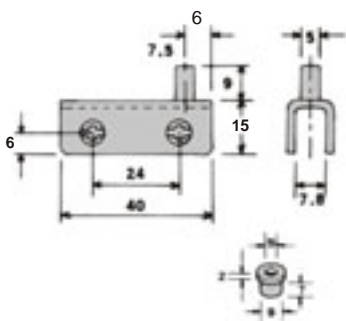
 PENTURE À VITRE AVEC VIS METAL ET ACCESSOIRES
 GLASS DOOR HINGE WITH METAL SCREWS AND ACCESSORIES

0501 - BL	BLANC / WHITE	-	250
0501 - CH	CHROME	-	250
0501 - LT	LAITON / BRASS	-	250
0501 - NR	NOIR / BLACK	-	250

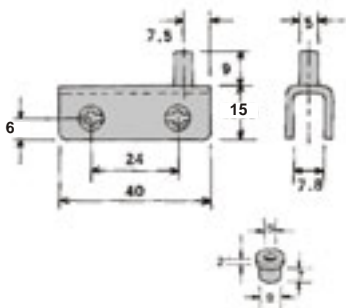
 PENTURE À VITRE AVEC VIS PLASTIQUE ET ACCESSOIRES
 GLASS DOOR HINGE WITH PLASTIC SCREWS AND ACCESSORIES

501M - NR	NOIR / BLACK	-	250
501M - CH	CHROME	-	250
501M - CS	CHR.: SATINE / SATIN	-	250

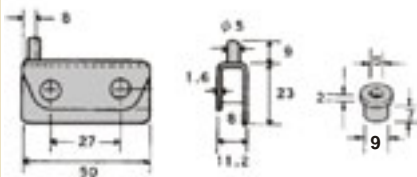
 PENTURE À VITRE AVEC VIS ZAMAC EMBOUTS PLASTIQUE ET ACCESSOIRES
 GLASS DOOR HINGE WITH PLASTIC TIPPED ZAMAC SCREWS AND ACCESSORIES

0502 - BL	BLANC / WHITE	200	400
0502 - CH	CHROME	200	400
0502 - LT	LAITON / BRASS	200	400
0502 - NR	NOIR / BLACK	200	400
0502 - AB	ANT.: LAITON / BRASS	200	400

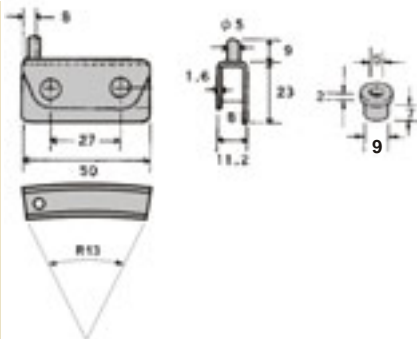
 PENTURE À VITRE AVEC VIS PLASTIQUE ET ACCESSOIRES
 GLASS DOOR HINGE WITH PLASTIC SCREWS AND ACCESSORIES

502CS - R13	CHR.: SATINE / SATIN	200	400
502L - R13	LAITON / BRASS	200	400
502N - R13	NOIR / BLACK	200	400

 PENTURE À VITRE POUR PORTE EN VITRE COURBÉE 13° AVEC VIS PLASTIQUE ET ACCESSOIRES
 GLASS DOOR HINGE FOR CURVED GLASS DOOR 13° WITH PLASTIC SCREWS AND ACCESSORIES

Qline

**PENTURES PIVOTANTES
PIVOT HINGES**

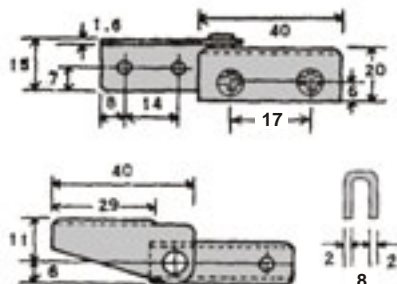

# QUINKO-TEK	FINI FINISH	CARTON CARTON	CAISSE CASE
0505 - BL	BLANC / WHITE	100	200
0505 - CH	CHROME	100	200
0505 - LT	LAITON / BRASS	100	200
0505 - NR	NOIR / BLACK	100	200

PENTURE À VITRE AVEC VIS PLASTIQUE ET ACCESSOIRES
GLASS DOOR HINGE WITH PLASTIC SCREWS AND ACCESSORIES

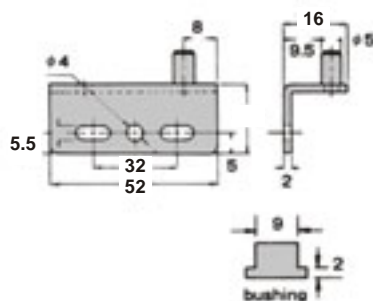

0503 - BL	BLANC / WHITE	-	250
0503 - NR	NOIR / BLACK	-	250

PENTURE POUR PORTE DE BOIS AVEC ACCESSOIRES
WOOD DOOR HINGE WITH ACCESSORIES

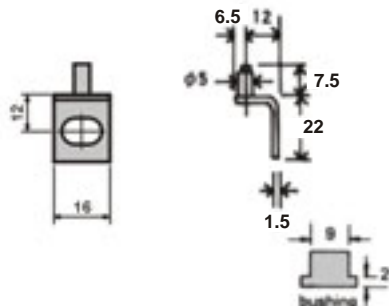
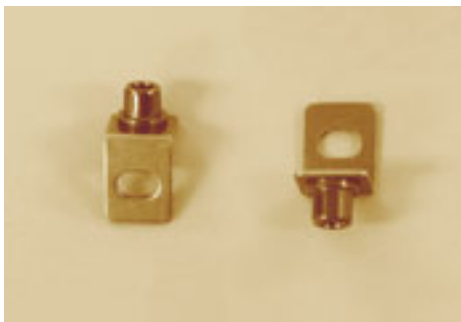

503M - NR	NOIR / BLACK	-	250
-----------	--------------	---	-----

PENTURE POUR PORTE DE BOIS AVEC ACCESSOIRES
WOOD DOOR HINGE WITH ACCESSORIES

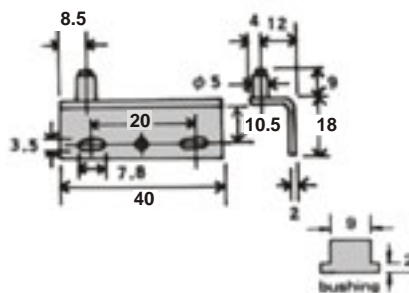

0506 - NR	NOIR / BLACK (VRAC / BULK)	150	1,500
P506N - 1/2	NOIR / BLACK (SAC / BAG)	-	500

PENTURE POUR PORTE DE BOIS AVEC ACCESSOIRES
WOOD DOOR HINGE WITH ACCESSORIES

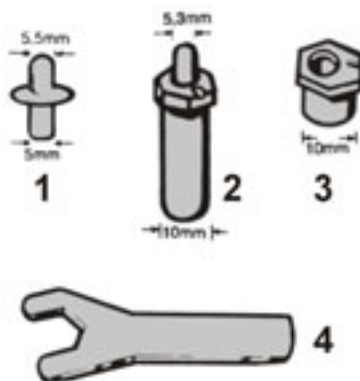
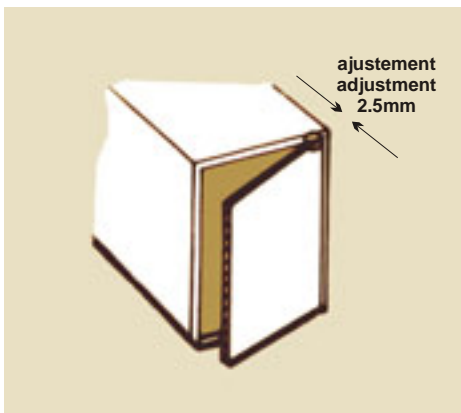

#	# QUINKO-TEK	DESCRIPTION	CAISSE CASE
1	0324 - DP	PIVOT EN PLASTIQUE BRUN BROWN PLASTIC PIVOT	5,000
2	0324 - GJ	GOUJON À RESSORT BRUN BROWN WITH SPRING	1,000
3	0324 - AH	RECEPTACLE EN PLASTIQUE BRUN BROWN PLASTIC RECEPTACLE	3,000
4	0324 - WR	CLEF D'AJUSTEMENT EN METAL METAL ADJUSTMENT WRENCH	1,000

SYSTÈME À PORTE PIVOTANTE ÉCONOMIQUE
ECONOMICAL PIVOTING DOOR SYSTEM

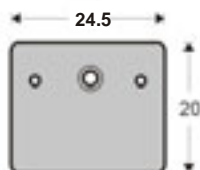
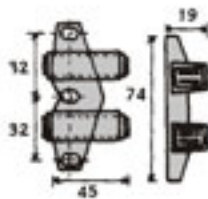
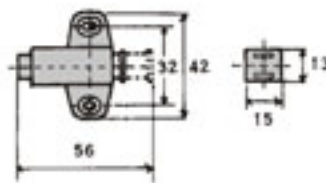
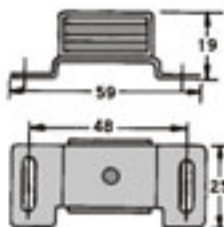
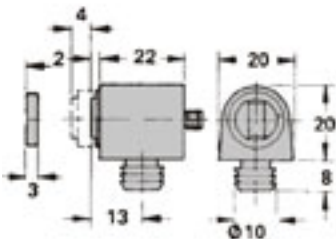
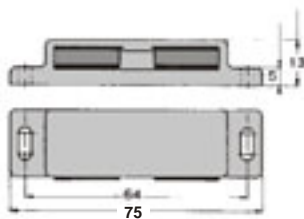
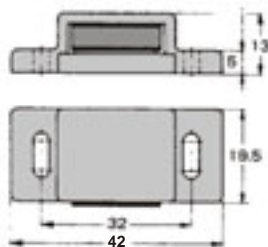
Qline
**AIMANTS
MAGNETS**

# QUINKO-TEK	FINI FINISH	CARTON	CAISSE CASE
0522 - BL	BLANC / WHITE	100	1,000
0522 - NR	NOIR / BLACK	100	1,000
0522 - BR	BRUN / BROWN	100	1,000
0522 - AM	AMANDE / ALMOND	100	1,000

**AIMANT SIMPLE
SINGLE MAGNET**

0523 - BL	BLANC / WHITE	100	500
0523 - NR	NOIR / BLACK	100	500
0523 - BR	BRUN / BROWN	100	500

**AIMANT DOUBLE
DOUBLE MAGNET**

0512 - NR	NOIR / BLACK	100	1,200
-----------	--------------	-----	-------

**AIMANT SIMPLE AJUSTABLE À ENFONCER
SINGLE ADJUSTABLE KNOCK-IN MAGNET**

P516 - ZC	ZINC	100	500
-----------	------	-----	-----

**AIMANT DOUBLE EXTRA FORT
EXTRA STRENGTH DOUBLE MAGNET**

0527 - BL	BLANC / WHITE	250	1,000
0527 - NR	NOIR / BLACK	250	1,000

**AIMANT POUSSOIR SIMPLE
SINGLE MAGNET PUSH LATCH**

0526 - BL	BLANC / WHITE	100	400
0526 - NR	NOIR / BLACK	100	400

**AIMANT POUSSOIR DOUBLE
DOUBLE MAGNET PUSH LATCH**

0524 - ZC	ZINC	-	3,000
0524 - NR	NOIR / BLACK	-	3,000

**PLAQUE D'AIMANTS
STRIKER PLATES**



POIGNÉES POUR PORTE EN VITRE, LOQUETS ET COUSSINETS
GLASS DOOR HANDLES, LATCHES AND BUMPERS

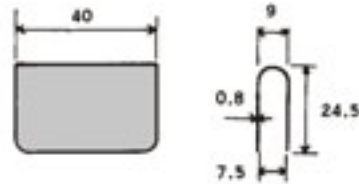

# QUINKO-TEK	FINI FINISH	CARTON	CAISSE CASE
0540 - BL	BLANC / WHITE	200	1,000
0540 - CH	CHROME	200	1,000
0540 - LT	LAITON / BRASS	200	1,000
0540 - NR	NOIR / BLACK	200	1,000

PLAQUE DE VITRE AVEC COUSSINET AUTOCOLLANT
GLASS DOOR CATCH WITH EVA PAD

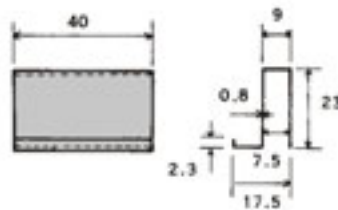

0541 - BL	BLANC / WHITE	200	1,000
0541 - CH	CHROME	200	1,000
0541 - LT	LAITON / BRASS	200	1,000
0541 - NR	NOIR / BLACK	200	1,000
0541 - AB	ANTIQUE	200	1,000
0541 - CS	CHR.: SATINE / SATIN	200	1,000

PLAQUE DE VITRE AVEC COUSSINET AUTOCOLLANT
GLASS DOOR CATCH WITH EVA PAD

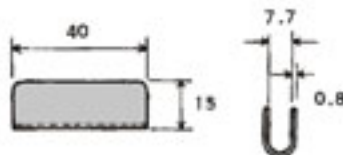

0544 - NR	NOIR / BLACK	200	1,000
-----------	--------------	-----	-------

PLAQUE DE VITRE AVEC COUSSINET AUTOCOLLANT
GLASS DOOR CATCH WITH EVA PAD

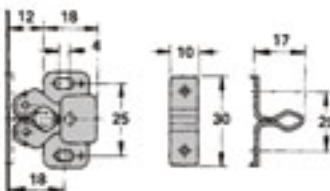

0532 - ZC	ZINC	100	1,000
0532 - BZ	BRONZE	100	1,000

LOQUET À ROULEAU
ROLLER CATCH

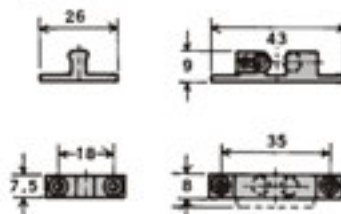
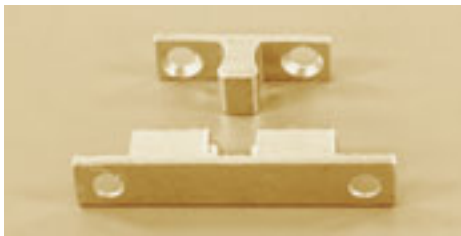

533L - 43	LAITON / BRASS	100	2,500
-----------	----------------	-----	-------

LOQUET À BILLES DOUBLE ACTION
SOLID BRASS DOUBLE BALL CATCH

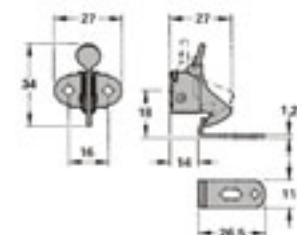

0534 - ZC	ZINC	100	1,000
0534 - BZ	BRONZE	100	1,000

LOQUET COUDÉ
ELBOW CATCH





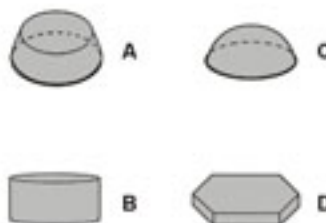



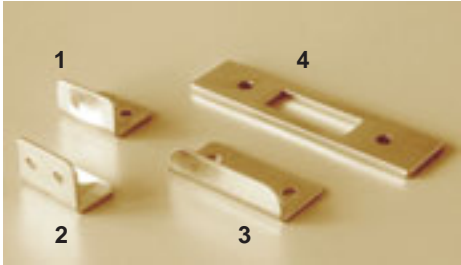
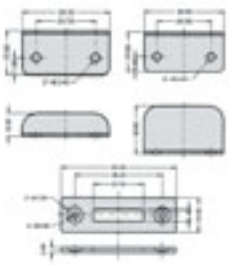
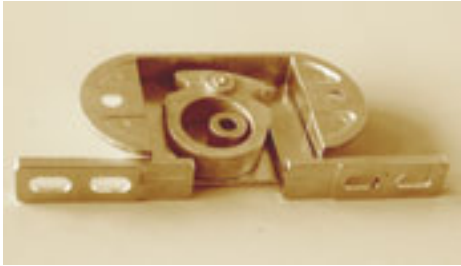
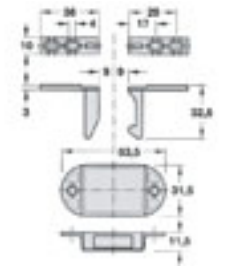

COUSSINETS AUTOCOLLANTS
SELF-STICK BUMPERS

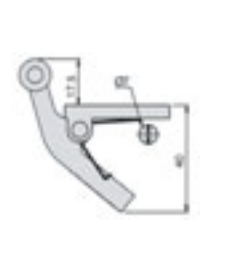

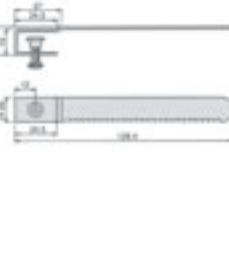
# QUINKO-TEK	COULEUR COLOR	STYLE	DIMENSION H x DIAM.	CAISSE CASE
546P - CL	CLAIR CLEAR	A	3.5x12.7mm	5,000
546P - BL	BLANC WHITE	A	3.5x12.7mm	5,000
546P - NR	NOIR BLACK	A	3.5x12.7mm	5,000
547P - CL	CLAIR CLEAR	C	2.2x8.5mm	5,400
548P - CL	CLAIR CLEAR	C	5 x 11.1mm	5,082
548P - NR	NOIR BLACK	C	5 x 11.1mm	5,082
549P - LN	NOIR BLACK	B	1/8 x 1/2	3,800
543M - BL	BLANC WHITE	D	3 x 8.5mm	10,000

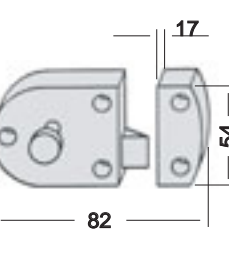
LOQUETS LATCHES

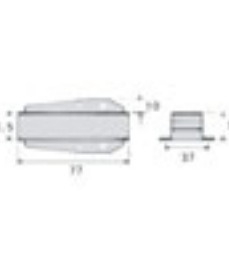
		# QUINKO-TEK	FINISH FINI	DESCRIPTION	CAISSE CASE
		# 1 31707 - LT	LAITON / BRASS	Plaquette de retenue pour serrures	100
		# 2 31707 - CH	CHROME		100
		# 3 31700 - CH	CHROME		100
		# 4 35239 - CH	CHROME		100
		30500 - CH	CHROME	Mécanisme de loquet pour portes doubles <i>Automatic hook latch for double door</i>	100
		35400 - BL	BLANC CHROME WHITE CHROME	Mécanisme de loquet pour portes doubles <i>Automatic hook latch for double door</i>	40
		220VT - CH	CHROME	Serrure pour portes verre coulissantes <i>Lock for glass sliding door</i>	12
		0536 - LT	LAITON BRASS	Locquet de surface pour porte	10
		0536 - CH	CHROME	<i>Surface door lock</i>	10
		0534 - ZC	ZINC	Locquet poussoir Touch-Latch <i>Touch-Latch Automatic Spring catch</i>	100

AIMANTS & LOCQUETS
MAGNETS & LATCHES

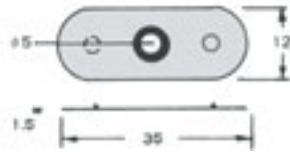

# QUINKO-TEK	FINISH FINI	CAISSE CASE
5240 - ZC	ZINC / ZINC	1,000
Plaque ovale pour aimant <i>Oval strike plate</i>		

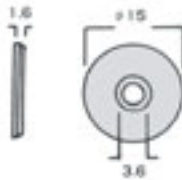

524R - ZC	ZINC / ZINC	1,000
Plaque ronde pour aimant <i>Round strike plate</i>		

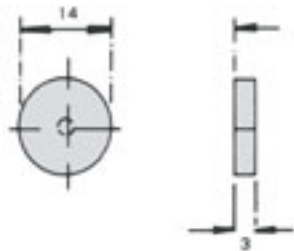

524S - ZC	ZINC / ZINC	1,000
Plaque ronde encollé pour aimant <i>Self adhesive strike plate</i>		



0521 - LT	LAITON / BRASS	100
Aimant double extra fort avec plaque <i>Heavy-duty magnet with strike plate</i>		

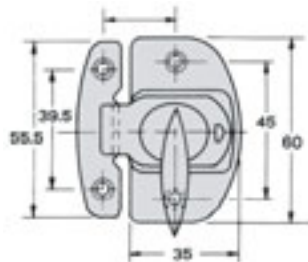

0535 - LT	LAITON / BRASS	100
Locquet de table laiton <i>Table lock</i>		

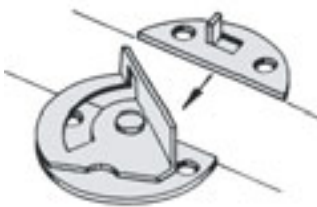

0464 - ZC	ZINC / ZINC	100
Locquet de table rond <i>Pivoting table lock</i>		



0424 - ZC	ZINC / ZINC	100
Locquet de coffre <i>Tension lever locking action</i>		

PENTURES TRADITIONNELLES / TRADITIONAL HINGES

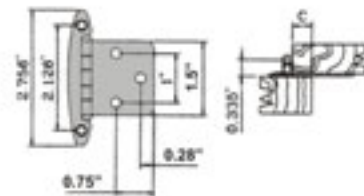

# QUINKO-TEK	FINI FINISH	C =	CAISSE CASE
P431 - AC	CUIVRE / COPPER	VARIABLE	100 prs
P431 - AM	AMANDE / ALMOND	VARIABLE	100 prs
P431 - AT	ANTIQUE	VARIABLE	100 prs
P431 - BL	BLANC / WHITE	VARIABLE	100 prs
P431 - CH	CHROME	VARIABLE	100 prs
P431 - GR	GRIS / GREY	VARIABLE	100 prs
P431 - LT	LAITON / BRASS	VARIABLE	100 prs
P431 - NR	NOIR / BLACK	VARIABLE	100 prs

AVEC VIS ET COUSSINETS / WITH SCREWS AND BUMPERS

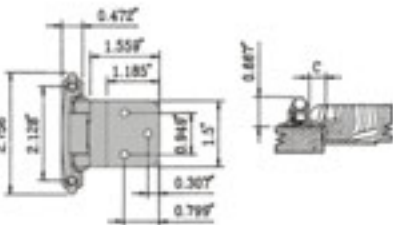

P432 - AT	ANTIQUE	3/8"	100 prs
P432 - BL	BLANC / WHITE	3/8"	100 prs
P432 - CH	CHROME	3/8"	100 prs

AVEC VIS ET COUSSINETS
WITH SCREWS AND BUMPERS

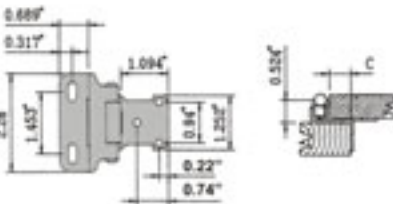

P433 - BL	BLANC - WHITE	5/8"	100 prs
P434 - AT	ANTIQUE (systeme 32mm)	1/4"	100 prs

AVEC VIS ET COUSSINETS
WITH SCREWS AND BUMPERS

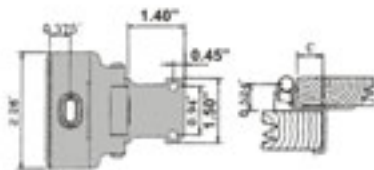

0433 - AT	ANTIQUE	1/2"	200 pcs
-----------	---------	------	---------

VIS ET COUSSINETS NON INCLUS
SCREWS AND BUMPERS NOT INCLUDED

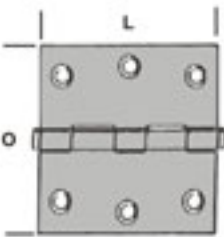

# QUINKO-TEK	FINI FINISH	O	L	CAISSE CASE
439N - 1	NICKEL	1"	1"	12 prs
439L - 1	LAITON / BRASS	1"	1"	12 prs
439N - 2	NICKEL	1 1/4"	1 1/2"	12 prs
439L - 2	LAITON / BRASS	1 1/4"	1 1/2"	12 prs
439N - 3	NICKEL	1 1/2"	2"	12 prs
439L - 3	LAITON / BRASS	1 1/2"	2"	12 prs
439N - 4	NICKEL	1 5/8"	2 1/2"	12 prs
439L - 4	LAITON / BRASS	1 5/8"	2 1/2"	12 prs

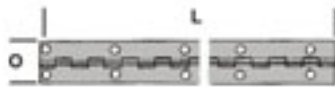

0451 - NC	NICKEL	1 1/4"	72"	10
0451 - LT	LAITON / BRASS	1 1/4"	72"	10
0452 - NC	NICKEL	1 1/2"	72"	10
0452 - LT	LAITON / BRASS	1 1/2"	72"	10
0453 - NC	NICKEL	2"	72"	10
0453 - LT	LAITON / BRASS	2"	72"	10
453N - 84	NICKEL	2"	84"	10

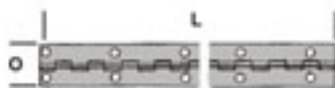
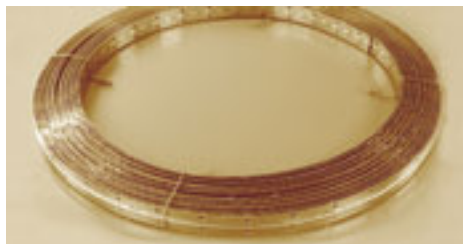

0450 - NC	NICKEL	1 1/4"	100'	3
-----------	--------	--------	------	---

LONGUEURS SPÉCIALES DISPONIBLES SUR COMMANDE
SPECIAL LENGTHS AVAILABLE ON ORDER

PENTURES TRADITIONNELLES / TRADITIONAL HINGES

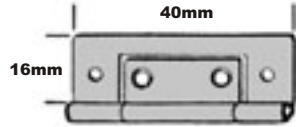
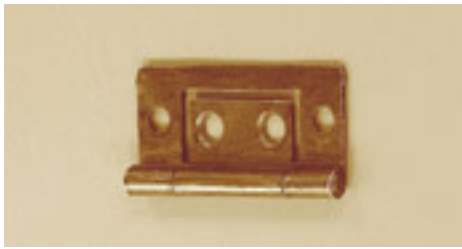

# QUINKO-TEK	FINI FINISH	CAISSE CASE
0401 - NR	NOIR - BLACK	1,000

CHARNIÈRE RASÉE
FLUSH HINGE

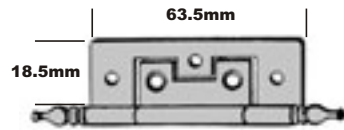

0413 - BZ	BRONZE	500
0413 - LT	LAITON - BRASS	500

CHARNIÈRE RASÉE
FLUSH HINGE

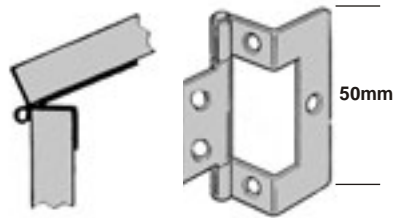

0428 - LT	LAITON - BRASS	500
-----------	----------------	-----

CHARNIÈRE RASÉE POUR PANNEAU 5/8" OU 11/16"
FLUSH HINGE FOR 5/8" OR 11/16" PANEL

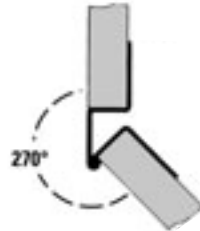

428N - 270	NICKEL	200
428L - 270	LAITON - BRASS	200

CHARNIÈRE RASÉE POUR PANNEAU 16mm
FLUSH HINGE FOR 16mm PANEL

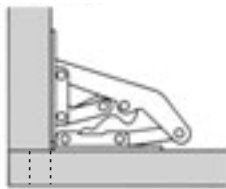
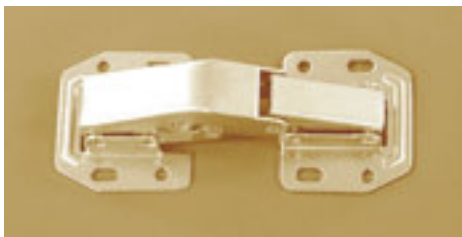

SP415 - ZC	ZINC	100
------------	------	-----

CHARNIÈRE À APPLICATION MULTIPLE
ACCOMMODATES VARIOUS OVERLAYS



346N - 35	ZINC	100
-----------	------	-----

CHARNIÈRE 90° POUR PORTE À ABATTANT
90° HINGE FOR FLAP DOOR

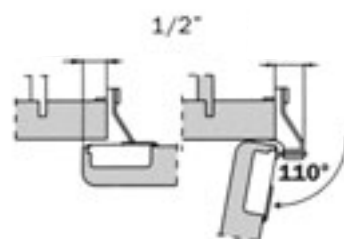

414N - FF	NICKEL	100
-----------	--------	-----

CHARNIÈRE "FACE FRAME" 45mm C.C. / GOUJONS 8mm
FACE FRAME HINGE 45mm C.C. / 8mm DOWELS

PENTURES TRADITIONNELLES / TRADITIONAL HINGES

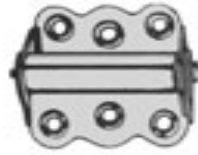

# QUINKO-TEK	FINISH FINI	CAISSE CASE
438Z - RS	ZINC / ZINC	100 prs

Charnières a ressort 43mm lrg x 55mm haut
Spring hinges 43mm wide x 55mm height

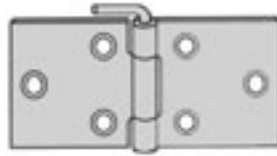

439ZD - 4 1/4	ZINC / ZINC	100 pcs
---------------	-------------	---------

Charnières de théâtre fiche amovible coudée
Theatre hinges bent loose pin 2 x 4 - 1/4"

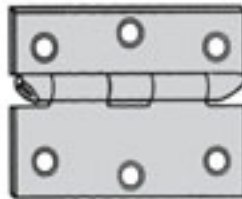

439NR - 2 1/2	NOIR / BLACK	100 pcs
---------------	--------------	---------

Charnières de laboratoire 2 - 1/2" x 1 - 3/4"
Laboratory hinges 2 - 1/2" x 1 - 3/4"



0429 - LT	LAITON / BRASS	100 pcs
-----------	----------------	---------

Charnières de paravent 1 - 3/4" x 3/4"
Folding door hinges 1 - 3/4" x 3/4"



438L - AF	LAITON / BRASS	100 sets
-----------	----------------	----------

Charnières à pivot de gravité pour portes 3/4"
Gravity hinges for 3/4" doors

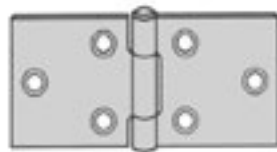

439Z - 2 3/4	1 x 2 - 3/4"	ZINC / ZINC	100 sets
439Z - 3 1/4	1 - 1/4 x 3 - 1/4"	ZINC / ZINC	
439Z - 3 1/2	1 - 1/2 x 3 - 1/2"	ZINC / ZINC	

Charnières pour coffré avec fiche rivée
Back flap hinges with fixed pin



0416 - ZC	ZINC / ZINC	100 pcs
-----------	-------------	---------

Charnières à pivot pour miroir 13/16 x 1 - 11/16 x 7/16"
Pivot hinges for mirror 13/16 x 1 - 11/16 x 7/16"

PENTURES TRADITIONNELLES / TRADITIONAL HINGES

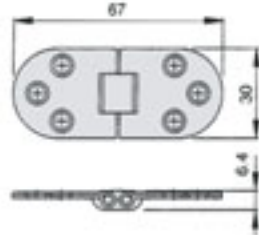

# QUINKO-TEK	FINISH FINI	CAISSE CASE
430L - 67 Charnière / Hinge	LAITON / BRASS 67 x 30 mm	200

Charnière régulière 1 3/16 X 2 5/8
Regular hinges 1 3/16 X 2 5/8

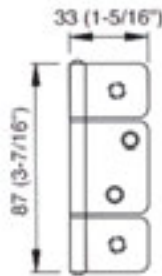

413L - 3 7/16	LAITON / BRASS	200
413AT - 3 7/16	LAITON ANTIQUE / ANTIQUE BRASS	200

Charnière rasée 3 7/16 X 1 5/16
Flush hinge 3 7/16 X 1 5/16



466N - 4	4" NOIR / BLACK	1 pr
466CS - 4	4" CHROME SATIN 4" SATIN CHROME	1 pr
466N - 5	5" NOIR / BLACK	1 pr
466CS - 5	5" CHROME SATIN 5" SATIN CHROME	1 pr

Charnières à ressort double action de type industriel
Double action spring hinges industrial type



467N - 3	3" NOIR / BLACK	1 pr
467N - 4	4" NOIR / BLACK	1 pr

Charnières à ressort double action de type résidentiel
Double action spring hinges residential type



0508 - LT	LAITON / BRASS	10
0508 - CH	CHROME / CHROME	10

Charnières pour porte de verre 5mm sans perçage
No hole glass door hinges for 5mm glass

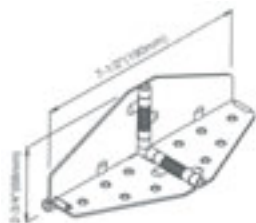

0489 - LT	CHROME (JAUNE) / CHROME (YELLOW)	24
-----------	----------------------------------	----

Pentures de tables 7 - 1/2 x 2 - 3/4"
Tables hinges 7 - 1/2 x 2 - 3/4"

PENTURES TRADITIONNELLES / TRADITIONAL HINGES

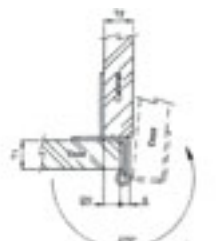
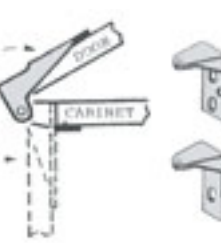
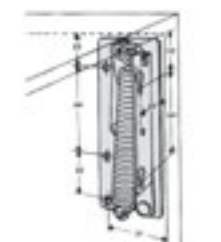
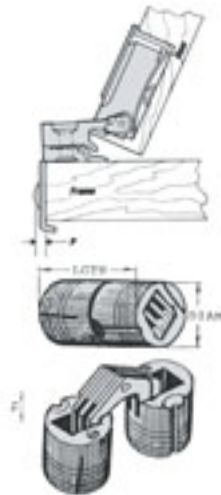

# QUINKO-TEK	RECOUVREMENT OVERLAY	FINISH FINI	CAISSE CASE
CM2007 - V - 14	1 - 1/4" +	ZINC / ZINC	50
CM2005 - A - 14	1"		50
CM2005 - B - 14	1 - 1/8"		50
CM2005 - H - 14	1/4"		50
CM2005 - J - 14	1/2"		50
CM2005 - K - 14	5/8"		50
CM2005 - L - 14	3/4"		50
CM2042 - I - 14	35mm	ZINC / ZINC	100
	Diam	Lg	
346L - 7/8	10mm	7/8"	100
346L - 1 1/16	12mm	1-1/16"	100
346L - 1 3/16	14mm	1-3/16"	100
346L - 1 5/16	16mm	1-5/16"	100
346L - 1 3/8	18mm	1-3/8"	100
346L - 2	20mm	2"	100
0248 - BL	-	BLANC / WHITE	20
0465 - ZC	3/4"	ZINC / ZINC	100
425LT - 70	9/16"	LAITON / BRASS	100
425CH - 70	9/16"	CHROME POLI BRIGHT CHROME	100
425CS - 70	9/16"	CHROME SATIN SATIN CHROME	100

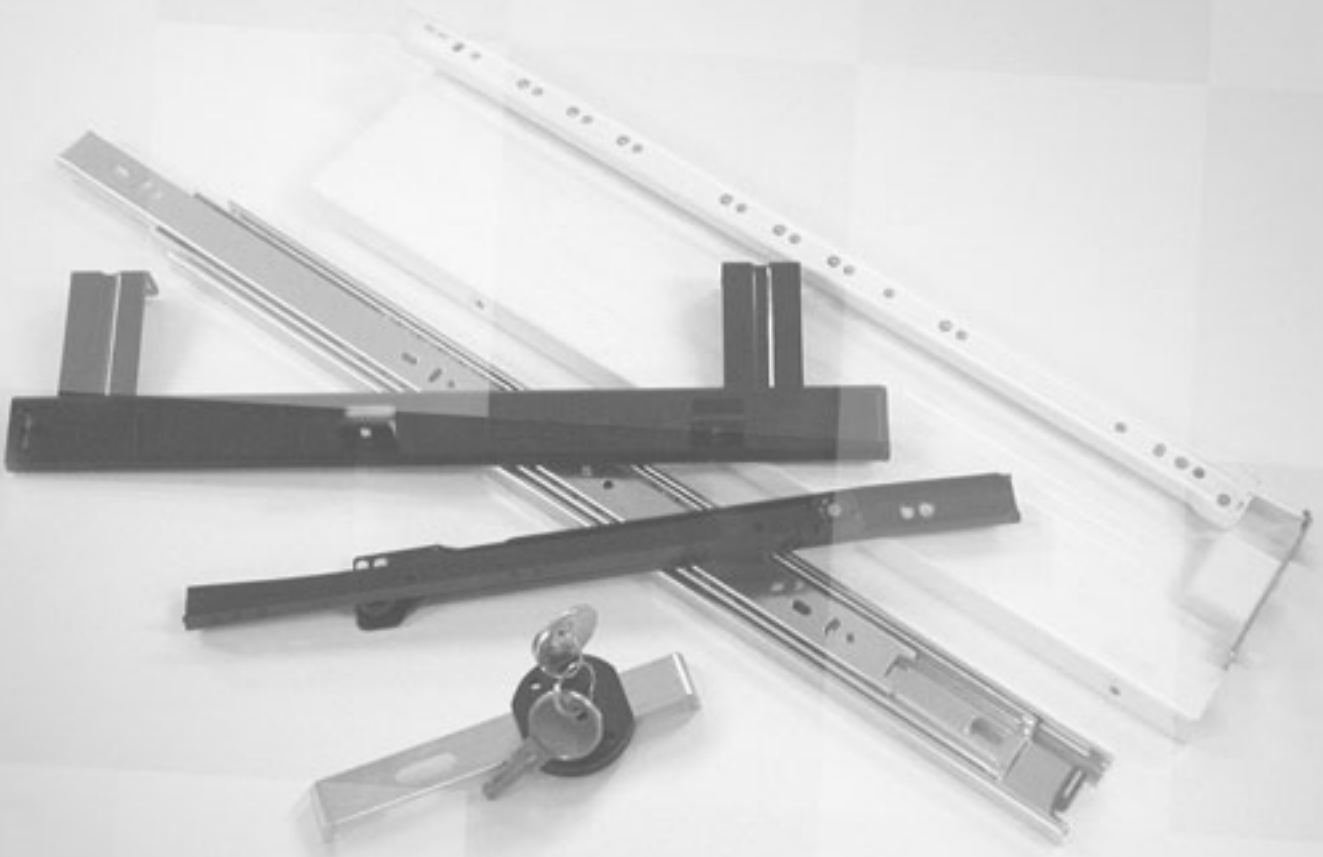

TAIMING

COULISSES AUTOFERMANTES SELF CLOSING SLIDES

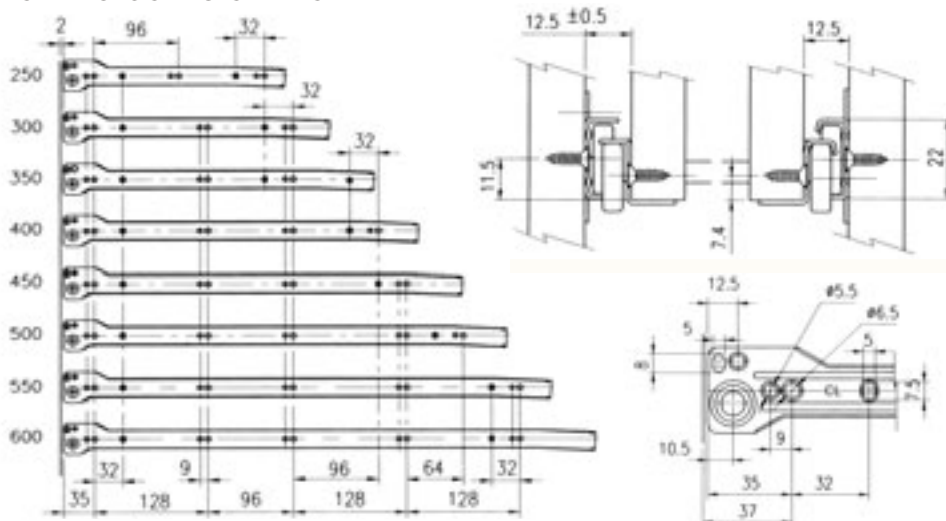
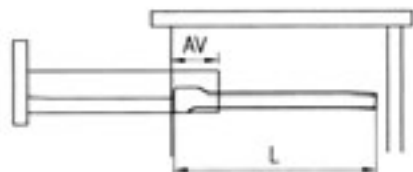

# QUINKO-TEK	COULEUR COLOR	LONGUEUR LENGTH	AV	CAPACITÉ CAPACITY	CAISSE (VRAC) (BULK) CASE	* CAISSE (TP) (TP) CASE
0650 - 10	BLANC / WHITE	250mm	85mm	55Lbs	100	20
0650 - 12	BLANC / WHITE	300mm	85mm	55Lbs	100	20
650N - 12	NOIR / BLACK	300mm	85mm	55Lbs	100	20
0650 - 14	BLANC / WHITE	350mm	85mm	55Lbs	100	20
650N - 14	NOIR / BLACK	350mm	85mm	55Lbs	100	20
0650 - 16	BLANC / WHITE	400mm	85mm	55Lbs	100	20
650N - 16	NOIR / BLACK	400mm	85mm	55Lbs	100	20
0650 - 18	BLANC / WHITE	450mm	95mm	55Lbs	100	20
650N - 18	NOIR / BLACK	450mm	95mm	55Lbs	100	20
0650 - 20	BLANC / WHITE	500mm	102mm	55Lbs	100	20
650N - 20	NOIR / BLACK	500mm	102mm	55Lbs	100	20
0650 - 22	BLANC / WHITE	550mm	109mm	55Lbs	100	20
650N - 22	NOIR / BLACK	550mm	109mm	55Lbs	100	20
0650 - 24	BLANC / WHITE	600mm	119mm	55Lbs	100	20

* PAIRE DE COULISSE ATTACHÉE INDIVIDUELLEMENT POUR DES APPLICATIONS PAA
 * PAIR OF SLIDES TAPED INDIVIDUALLY FOR RTA APPLICATIONS

TAIMING

COULISSES AUTOFERMANTES SERIE V SELF CLOSING SLIDES V SERIES

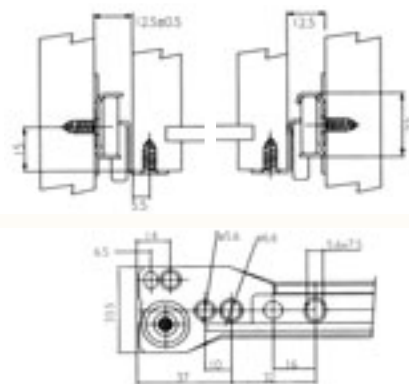

# QUINKO-TEK	COULEUR COLOR	LONGUEUR LENGTH	AV	CAPACITÉ CAPACITY	ÉPAISSEUR THICKNESS	CAISSE (VRAC) (BULK) CASE
650V - 14	BLANC / WHITE	350mm	87mm	55Lbs	1.2mm	100
650V - 16	BLANC / WHITE	400mm	87mm	55Lbs	1.2mm	100
* 650V - 18	BLANC / WHITE	450mm	97mm	55Lbs	1.2mm	100
* 650V - 20	BLANC / WHITE	500mm	97mm	55Lbs	1.2mm	100
* 650V - 22	BLANC / WHITE	550mm	117mm	55Lbs	1.2mm	100

AUTRES GRANDEURS ET COULEURS DISPONIBLES SUR COMMANDE SPÉCIALE / OTHER SIZES AND COLORS ARE AVAILABLE ON SPECIAL ORDER
 * COMMANDE SPÉCIALE / SPECIAL ORDER

TAIMING

COULISSES AUTOFERMANTES FIXATION DE CÔTÉ SELF CLOSING SLIDES SIDE MOUNT

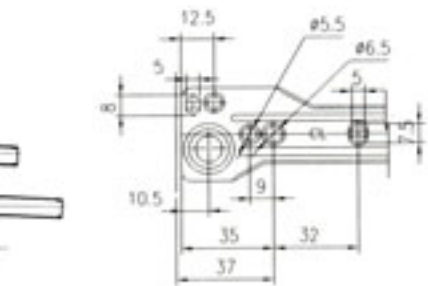
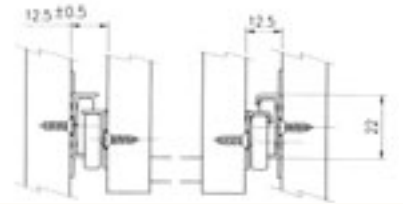
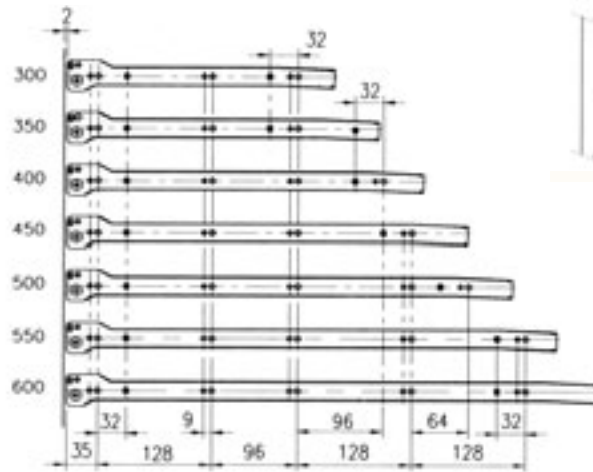
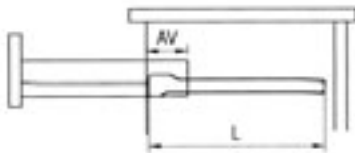

# QUINKO-TEK	COULEUR COLOR	LONGUEUR LENGTH	AV	CAPACITÉ CAPACITY	ÉPAISSEUR THICKNESS	CAISSE (VRAC) (BULK) CASE
* 0651 - 12	BLANC / WHITE	300mm	85mm	55Lbs	1.2mm	100
* 0651 - 14	BLANC / WHITE	350mm	85mm	55Lbs	1.2mm	100
* 0651 - 16	BLANC / WHITE	400mm	85mm	55Lbs	1.2mm	100
* 0651 - 18	BLANC / WHITE	450mm	95mm	55Lbs	1.2mm	100
* 0651 - 20	BLANC / WHITE	500mm	102mm	55Lbs	1.2mm	100
0651 - 22	BLANC / WHITE	550mm	109mm	55Lbs	1.2mm	100
* 0651 - 24	BLANC / WHITE	600mm	119mm	55Lbs	1.2mm	100

* DISPONIBLE SUR COMMANDE SPÉCIALE / AVAILABLE ON SPECIAL ORDER

TAIMING

COULISSES AUTOFERMANTES CLAMP-ON SELF CLOSING SLIDES CLAMP-ON

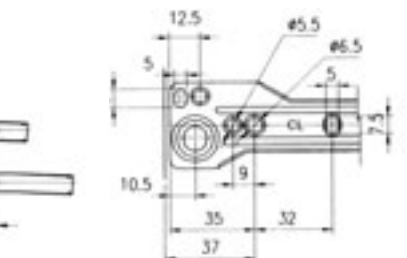
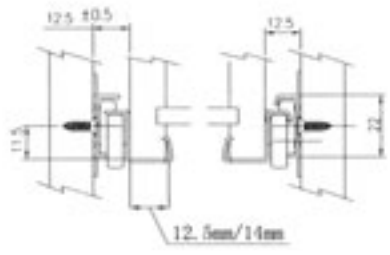
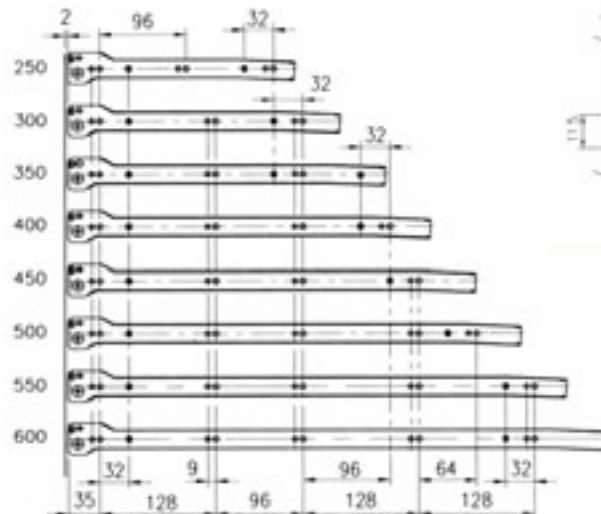
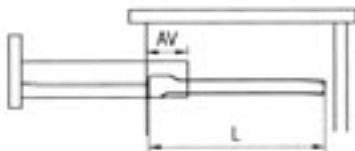

# QUINKO-TEK	COULEUR COLOR	LONGUEUR LENGTH	AV	CAPACITÉ CAPACITY	ÉPAISSEUR THICKNESS	CAISSE (VRAC) (BULK) CASE
* 650C - 12	BLANC / WHITE	300mm	85mm	55Lbs	1.2mm	100
650C - 14	BLANC / WHITE	350mm	85mm	55Lbs	1.2mm	100
* 650C - 16	BLANC / WHITE	400mm	85mm	55Lbs	1.2mm	100
* 650C - 18	BLANC / WHITE	450mm	95mm	55Lbs	1.2mm	100
* 650C - 20	BLANC / WHITE	500mm	102mm	55Lbs	1.2mm	100
* 650C - 22	BLANC / WHITE	550mm	109mm	55Lbs	1.2mm	100
* 650C - 24	BLANC / WHITE	600mm	119mm	55Lbs	1.2mm	100

* DISPONIBLE SUR COMMANDE SPÉCIALE / AVAILABLE ON SPECIAL ORDER

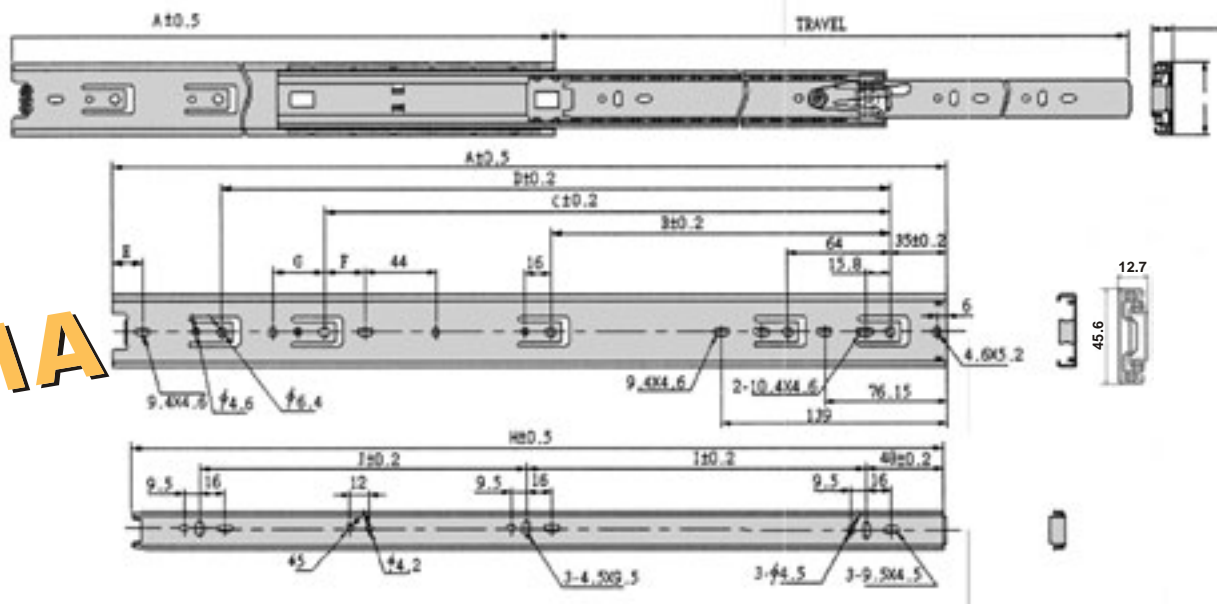

■ DE LA QUALITÉ À UN PRIX INCROYABLE

■ QUALITY AT AN INCREDIBLE PRICE

■ TRÈS SILENCIEUX / VERY QUIET

■ FACILITÉ DE L'EMBOÎTEMENT ET DU DÉBOÎTEMENT DU TIROIR / EASY MOUNTING AND DISMOUNTING

■ SYSTÈME 32MM / 32MM SYSTEM

# QUINKO-TEK	FINI FINISH	SURPASSEMENT OVERTRAVEL	A	B	C	D	E	F	G	H	I	J	CAISSE CASE
601Z - 08	ZINC / ZINC	25mm	200	148	-	-	-	-	-	195	-	-	10
601Z - 10	ZINC / ZINC	25mm	250	148	-	-	-	-	-	245	76	-	10
601Z - 12	ZINC / ZINC	25mm	300	224	-	-	-	-	-	295	96	128	10
601Z - 14	ZINC / ZINC	25mm	350	224	-	-	46.6	-	-	345	128	128	10
* 601N - 14	NOIR / BLACK	25mm	350	224	-	-	46.6	-	-	345	128	128	10
601Z - 16	ZINC / ZINC	25mm	400	224	288	-	33.4	-	-	395	160	160	10
* 601N - 16	NOIR / BLACK	25mm	400	224	288	-	33.4	-	-	395	160	160	10
601Z - 18	ZINC / ZINC	16mm	450	224	352	-	-	25.45	32.15	445	160	192	10
601N - 18	NOIR / BLACK	16mm	450	224	352	-	-	25.45	32.15	445	160	192	10
601Z - 20	ZINC / ZINC	16mm	500	224	352	416	-	25.45	32.15	495	192	224	10
* 601N - 20	NOIR / BLACK	16mm	500	224	352	416	-	25.45	32.15	495	192	224	10
601Z - 22	ZINC / ZINC	16mm	550	224	352	416	57.8	25.45	32.15	545	224	224	10
* 601N - 22	NOIR / BLACK	16mm	550	224	352	416	57.8	25.45	32.15	545	224	224	10
601Z - 24	ZINC / ZINC	16mm	600	224	352	480	44.8	25.45	32.15	595	256	256	10
601Z - 26	ZINC / ZINC	16mm	650	224	352	544	31.8	25.45	32.15	645	288	288	10
601Z - 28	ZINC / ZINC	16mm	700	224	352	544	82.2	25.45	32.15	695	288	288	10

* INVENTAIRE LIMITÉ OU COMMANDE SPÉCIALE / LIMITED STOCK OR SPECIAL ORDER

Qline

**COULISSE À BILLES 3/4 EXTENSION
3/4 EXTENSION BALL BEARING SLIDE**



TRÈS SILENCIEUX / VERY QUIET
FACILE D'EMBOÎTEMENT ET DE DÉBOÎTEMENT DU TIROIR
EASY DRAWER MOUNTING AND DISMOUNTING
SYSTÈME 32mm / 32mm SYSTEM

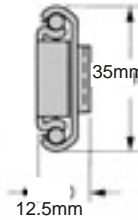

# QUINKO-TEK	LONGUEUR LENGTH	FINI FINISH	CAPACITÉ CAPACITY	PERTE DE VOYAGEMENT LOSS OF TRAVEL DISTANCE	CAISSE CASE
600Z - 14	350mm	ZINC / ZINC	75Lbs	85.86mm	10
600Z - 16	400mm		75Lbs	98.55mm	10
600Z - 18	450mm		75Lbs	111.26mm	10
600Z - 20	500mm		75Lbs	123.95mm	10
600Z - 22	550mm		75Lbs	136.65mm	10

AUTRES GRANDEURS ET COULEURS DISPONIBLES SUR COMMANDE SPÉCIALE
OTHER SIZES AND COLORS ARE AVAILABLE ON SPECIAL ORDER

Qline

**COULISSE CLAVIER À BILLES 3/4 EXTENSION
3/4 EXTENSION BALL BEARING KEYBOARD SLIDE**

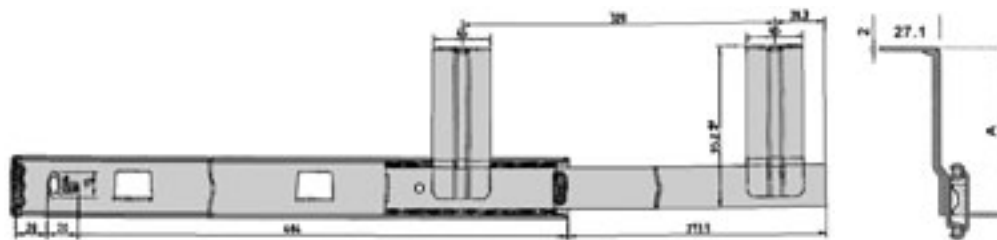
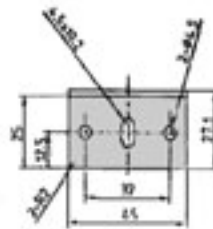
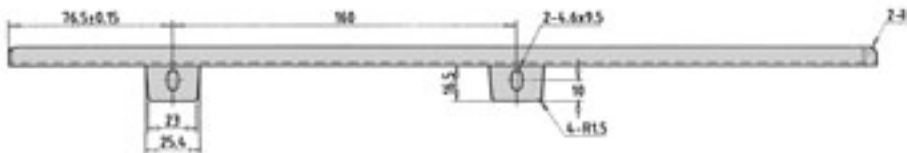

# QUINKO-TEK	A	LONGUEUR LENGTH	COULEUR COLOR	CAPACITÉ CAPACITY	PERTE DE VOYAGEMENT LOSS OF TRAVEL DISTANCE	CAISSE CASE
603N-320 / 16/3 1/2"	75.5mm	404mm	NOIR / BLACK	60Lbs	120mm	10
603N-320 / 16/4"	89mm	404mm	NOIR / BLACK	60Lbs	120mm	10

Qline

**COULISSE CLAVIER À BILLES PLEINE EXTENSION
FULL EXTENSION BALL BEARING KEYBOARD SLIDE**

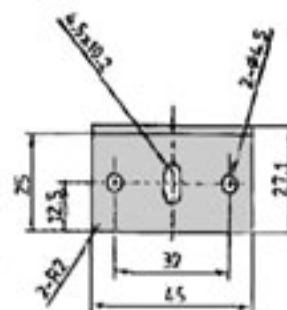
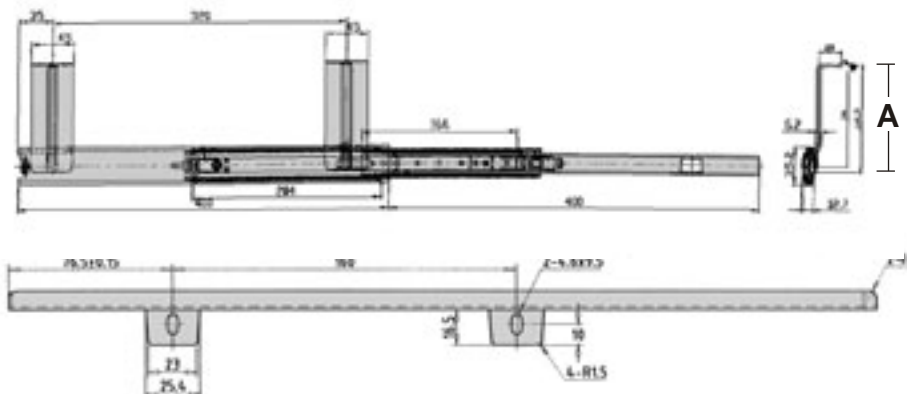

# QUINKO-TEK	A	LONGUEUR LENGTH	COULEUR COLOR	CAPACITÉ CAPACITY	PERTE DE VOYAGEMENT LOSS OF TRAVEL DISTANCE	CAISSE CASE
605N - 16/4"	89mm	404mm	NOIR / BLACK	60Lbs	-	10

Qline

**COULISSE CLAVIER AJUSTABLE EN HAUTEUR 3/4 EXTENSION
3/4 EXTENSION HEIGHT ADJUSTABLE KEYBOARD SLIDE**

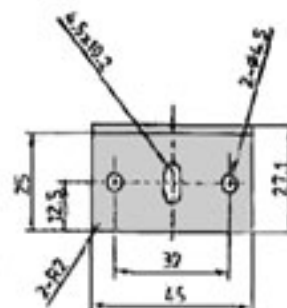
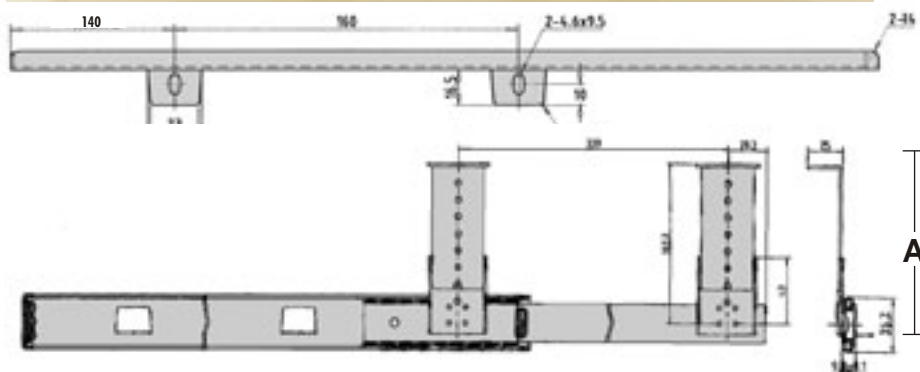

# QUINKO-TEK	A	LONGUEUR LENGTH	COULEUR COLOR	CAPACITÉ CAPACITY	PERTE DE VOYAGEMENT LOSS OF TRAVEL DISTANCE	CAISSE CASE
604N - 16	50 - 95mm	404mm	NOIR / BLACK	60Lbs	110mm	10

Qline

**COULISSE À BILLES PLEINE EXTENSION AUTO-FERMANTES
SELF-CLOSING FULL EXTENSION BALL BEARING SLIDE**

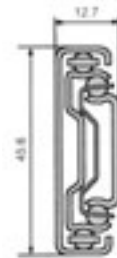

TRÈS SILENCIEUX / *VERY QUIET*
FACILE D'EMBOÎTEMENT ET DE DÉBOÎTEMENT DU TIROIR
EASY DRAWER MOUNTING AND DISMOUNTING
SYSTÈME 32mm / *32mm SYSTEM*

# QUINKO-TEK	LONGUEUR LENGTH	COULEUR COLOR	CAPACITÉ CAPACITY	SURPASSEMENT OVERTRAVEL	CAISSE CASE
601Z/AF - 14	350mm	ZINC / ZINC	100lbs	85.86mm	10
601Z/AF - 16	400mm		100lbs	98.55mm	10
601Z/AF - 18	450mm		100lbs	111.26mm	10
601Z/AF - 20	500mm		100lbs	123.95mm	10
601Z/AF - 22	550mm		100lbs	136.65mm	10

AUTRES GRANDEURS ET COULEURS DISPONIBLES SUR COMMANDE SPÉCIALE
OTHER SIZES AND COLORS ARE AVAILABLE ON SPECIAL ORDER

Qline

**COULISSE POUR PORTE RETRACTABLE
POCKET DOOR SLIDE**

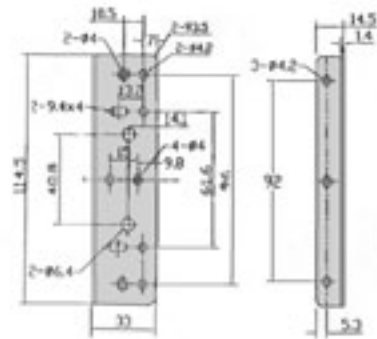

# QUINKO-TEK	LONGUEUR LENGTH	COULEUR COLOR	CAPACITÉ CAPACITY	CAISSE CASE
606Z - 14	350mm	ZINC / ZINC	60Lbs	10
606Z - 16	400mm		60Lbs	10
606Z - 18	450mm		60Lbs	10
606Z - 20	500mm		60Lbs	10

* Aussi disponibles en noir / *Also available in black*

Qline

**COULISSE À BILLES PLEINE EXTENSION AVEC RAIL
FULL EXTENSION BALL BEARING SLIDE WITH RAIL**



TRÈS SILENCIEUX • FACILE D'EMBOÎTEMENT ET DE DÉBOÎTEMENT DU TIROIR
VERY QUIET • EASY DRAWER MOUNTING AND DISMOUNTING

# QUINKO-TEK	LONGUEUR LENGTH	SURPASSEMENT OVERTRAVEL	FINI FINISH	CAPACITÉ CAPACITY	CAISSE CASE
614Z - 14	14 po / in	1 po / in	ZINC	150 Lbs	5
614Z - 16	16 po / in	1 po / in		150 Lbs	5
614Z - 18	18 po / in	1 po / in		150 Lbs	5
614Z - 20	20 po / in	1 po / in		150 Lbs	5
614Z - 22	22 po / in	1 po / in		150 Lbs	5

AUTRES GRANDEURS ET COULEURS DISPONIBLES SUR COMMANDE SPÉCIALE
OTHER SIZES AND COLORS ARE AVAILABLE ON SPECIAL ORDER

**SUPPORTS POUR CHEMISES SUSPENDUES (FORMATS LETTRE ET LÉGAL)
SUSPENDED FOLDER HANGERS (LETTER AND LEGAL FORMATS)**

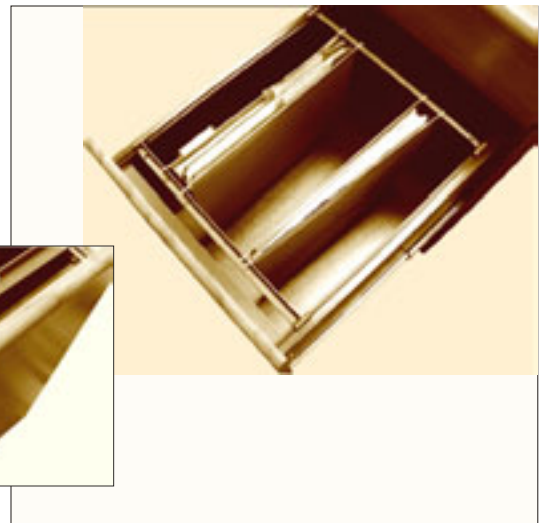

# QUINKO-TEK	LONGUEUR LENGTH	COULEUR COLOR	CAISSE CASE
225N-317	317 mm	NOIR / BLACK	250
225N - 394	394 mm		250



AUTRES GRANDEURS ET COULEURS DISPONIBLES SUR COMMANDE SPÉCIALE
OTHER SIZES AND COLORS ARE AVAILABLE ON SPECIAL ORDER

Qline

**SERRURES
LOCKS**

**NOYAU AMOVIBLE
CORE REMOVEABLE** !

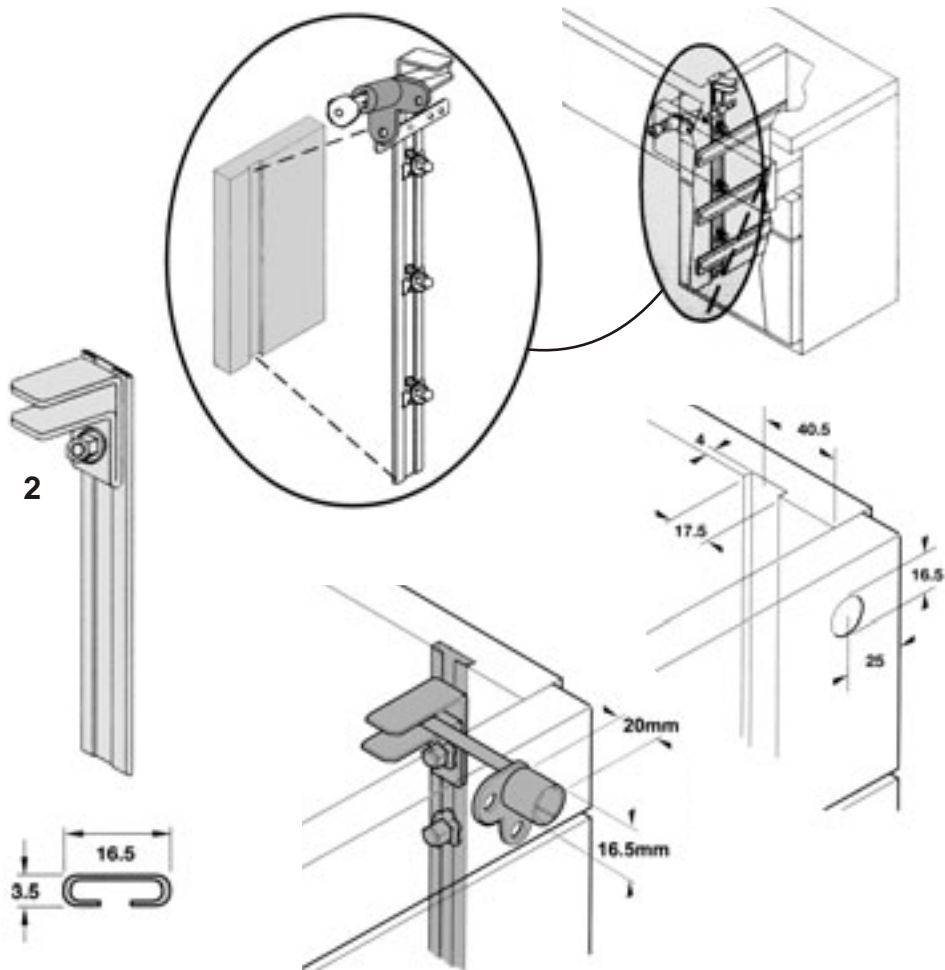
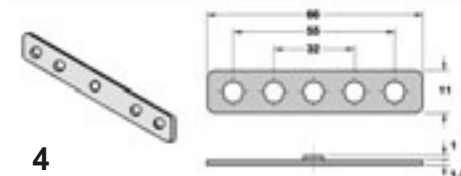

#	# QUINKO-TEK	DESCRIPTION	CAISSE CASE
1	251N - SFC	serrure avec tige 32mm L. / lock w. 32mm L. rod	200
2	254C - BR	tige 500mm avec guide / 500mm lock bar w. guide	50
3	255A - CV	cheville ajustable / adjustable peg	1,000

#	# QUINKO-TEK	DESCRIPTION	CAISSE CASE
4	256S - BR	support de tige / bar holder	2,000
5	0123 - NR	arrêt pour tiroir / drawer locking wedge	1,000

LE CYLINDRE ET LE BOÎTIER PEUVENT ÊTRE INTERCHANGÉS AVEC UNE CLÉ DE "NOYAU AMOVIBLE" (MULTIPLES NUMEROS DE CLÉS DISPONIBLES)
LOCK CORES CAN BE INTERCHANGED USING A "CORE REMOVAL" KEY (MULTIPLE KEY NUMBERS AVAILABLE)

Qline

**SERRURES
LOCKS**

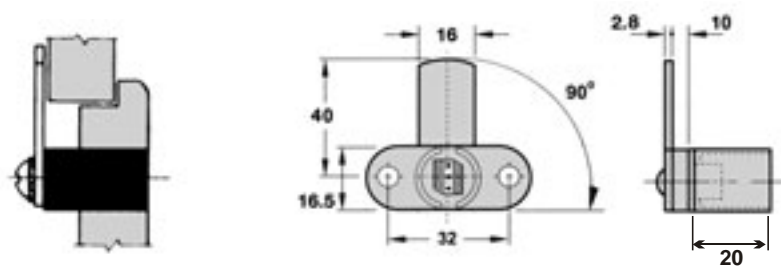

#	# QUINKO-TEK	DESCRIPTION	CAISSE CASE
1	252N - PB	serrure à penne battant droit / cam lock with straight extended lever	200

LE CYLINDRE ET LE BOÎTIER PEUVENT ÊTRE INTERCHANGÉS AVEC UNE CLÉ DE "NOYAU AMOVIBLE" (MULTIPLES NUMEROS DE CLÉS DISPONIBLES)
LOCK CORES CAN BE INTERCHANGED USING A "CORE REMOVAL" KEY (MULTIPLE KEY NUMBERS AVAILABLE)

Q line

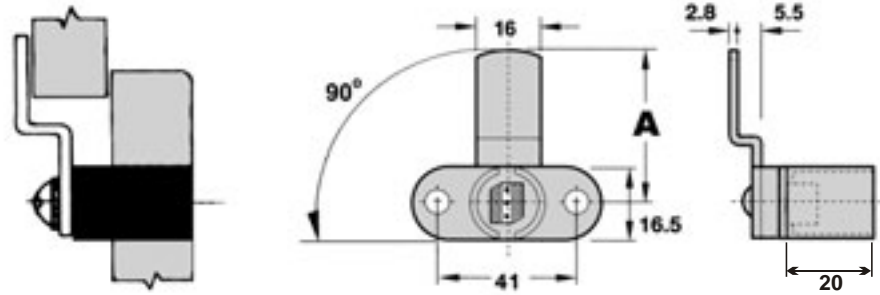
**SERRURES
LOCKS**
**NOYAU AMOVIBLE
CORE REMOVEABLE**

#	# QUINKO-TEK	A	DESCRIPTION	CAISSE CASE
1	262N - PB	45mm	serrure à penne battante 3/8" / lock with 3/8" extended lever	200
1	263N - PB	70mm	serrure à penne battante 3/8" / lock with 3/8" extended lever	200

LE CYLINDRE ET LE BOÎTIER PEUVENT ÊTRE INTERCHANGÉS AVEC UNE CLÉ DE "NOYAU AMOVIBLE" (MULTIPLES NUMEROS DE CLÉS DISPONIBLES)
 LOCK CORES CAN BE INTERCHANGED USING A "CORE REMOVAL" KEY (MULTIPLE KEY NUMBERS AVAILABLE)

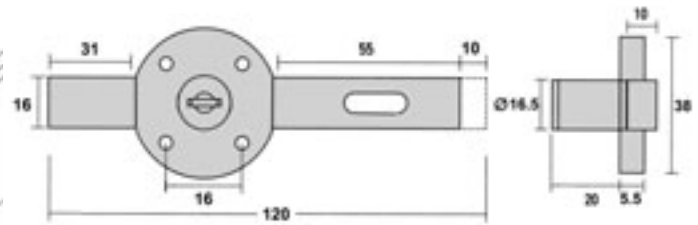
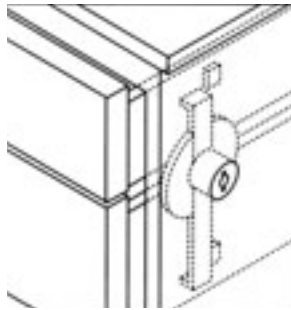
Q line
**SERRURES
LOCKS**

#	# QUINKO-TEK	DESCRIPTION	CAISSE CASE
1	250N - MG	serrure à barrure double 120mm / mini gang lock 120mm	200

LE CYLINDRE ET LE BOÎTIER PEUVENT ÊTRE INTERCHANGÉS AVEC UNE CLÉ DE "NOYAU AMOVIBLE" (MULTIPLES NUMEROS DE CLÉS DISPONIBLES)
 LOCK CORES CAN BE INTERCHANGED USING A "CORE REMOVAL" KEY (MULTIPLE KEY NUMBERS AVAILABLE)

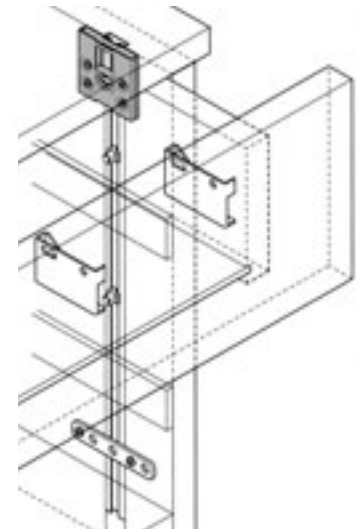
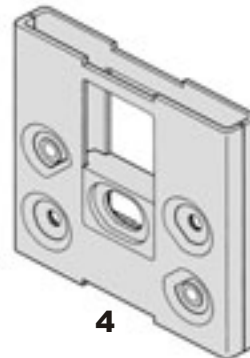
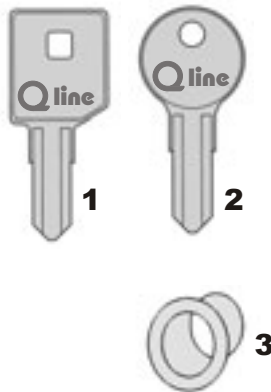
Q line
**ACCESSOIRES
ACCESORIES**

#	# QUINKO-TEK	DESCRIPTION	CAISSE CASE	#	# QUINKO-TEK	DESCRIPTION	CAISSE CASE
1	258K - NA	clé de noyau amovible / core removal key	500	3	253N - AF	rondelle de finition noire / black trim ring	1,000
2	259K - MK	clé maîtresse / master key	500	4	257M - AB	gachette anti-basculement / anti-tip device	500

harn

**JEU DE TUBES
RAIL SYSTEM**

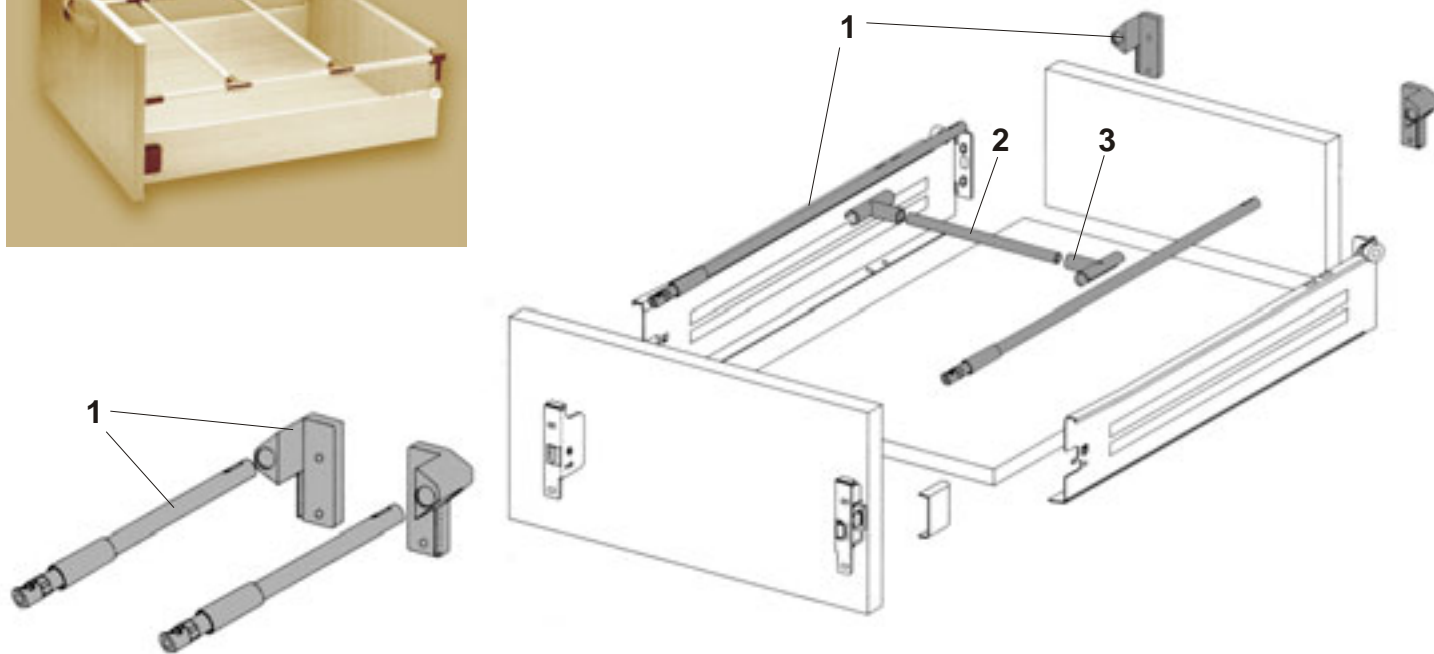

#	# QUINKO-TEK	COULEUR COLOR	DESCRIPTION	CARTON
1	662B - R18	BLANC / WHITE	système de fixation bois 450mm / 450mm rail system for wood	40
1	662B - R20	BLANC / WHITE	système de fixation bois 500mm / 500mm rail system for wood	40
1	662B - R22	BLANC / WHITE	système de fixation bois 550mm / 550mm rail system for wood	40
2	663B - 1000	BLANC / WHITE	tube 1000mm transversal / cross railing tube 1000mm	20
3	664B - FR	BLANC / WHITE	connecteur pour app. transversal / cross rail connector	40

harn

**GABARITS DE TRAÇAGE
TEMPLATE TOOLS**

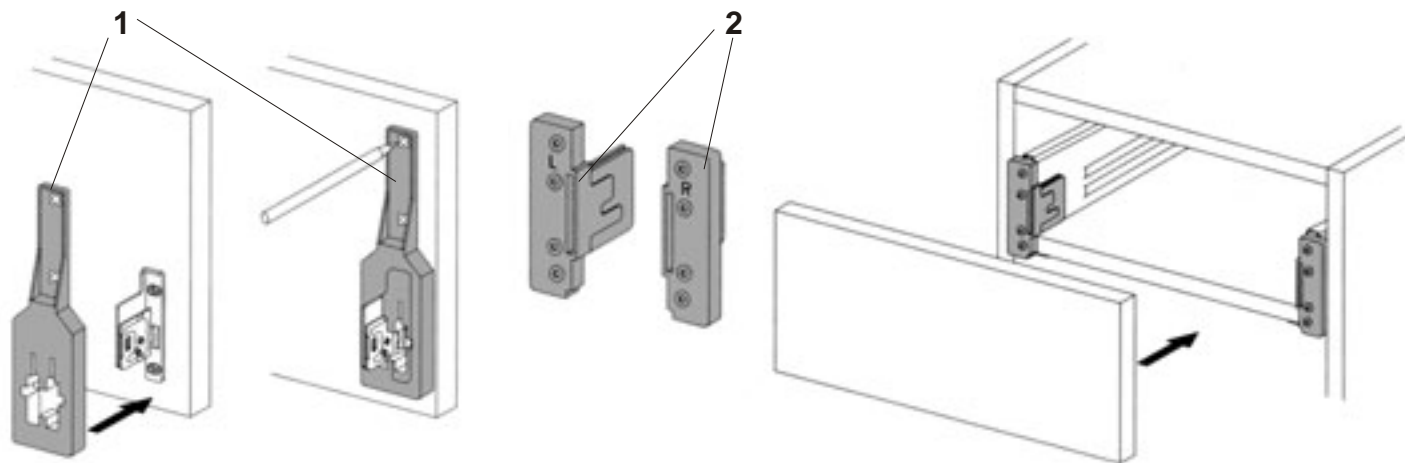

#	# QUINKO-TEK	DESCRIPTION
1	668T - TP	gabarit de traçage pour tubes longitudinaux / railing marking template
2	667T - JG	gabarit de traçage pour façade de tiroir / drawer marking jigs

harn

MATRICES DE PERÇAGE ET D'INSERTION DRILLING JIG AND INSERTION DEVICES

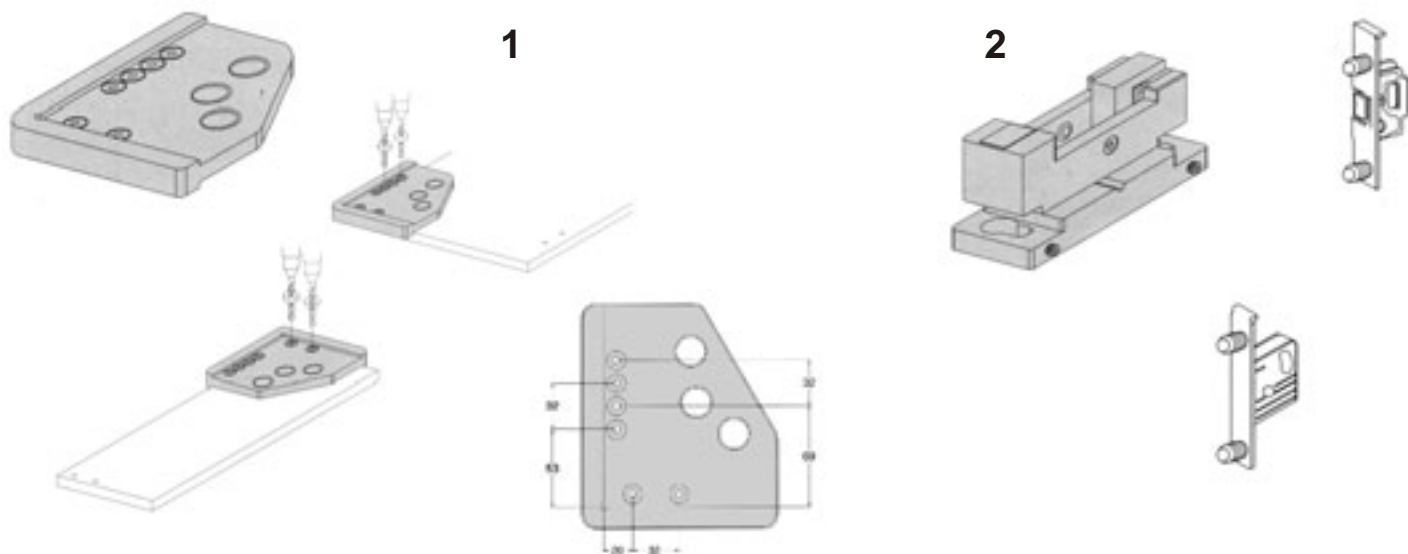

#	# QUINKO-TEK	DESCRIPTION
1	669T - PD	Gabarit de perçage pour fonds et panneaux arrière / <i>Drilling template for supporting and rear panels</i>
2	670M - CL	Matrice d'insertion manuelle pour fixtures "Clip-On" / <i>Manual insertion matrix for "Clip-On" fixtures</i>
2	670M - GF	Matrice d'insertion manuelle pour fixtures standard / <i>Manual insertion matrix for standard fixtures</i>
2	671M - CL	Matrice d'insertion automatique pour fixtures "Clip-On" / <i>Automatic insertion matrix for "Clip-On" fixtures</i>
2	671M - GF	Matrice d'insertion automatique pour fixtures standard / <i>Automatic insertion matrix for standard fixtures</i>

harn 4021

CÔTÉ DE TIROIR MÉTALLIQUE COULISSANT IMPAZ 85mm A/ GOUPILLE "PLUG-IN" 85mm IMPAZ SLIDING METAL DRAWER SIDE

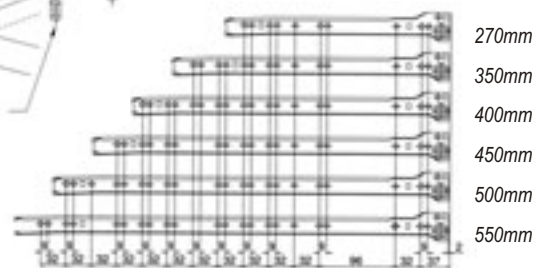
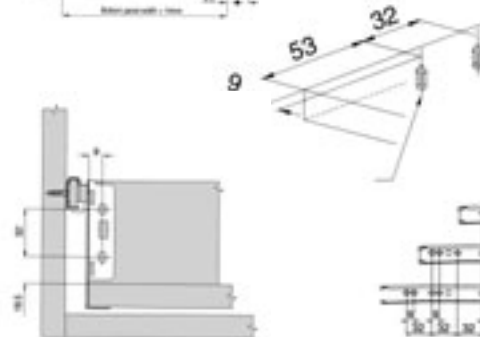
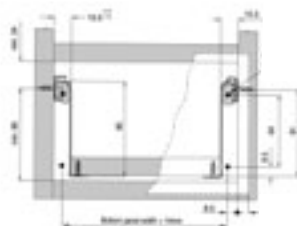
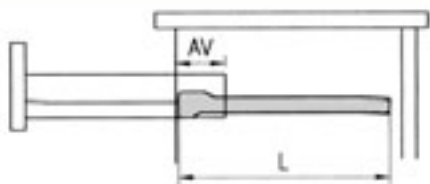

# QUINKO-TEK	COULEUR COLOR	LONGUEUR LENGTH	AV	CAPACITÉ CAPACITY	ÉPAISSEUR THICKNESS	CAISSE (VRAC) (BULK) CASE
658B - 85 - 14	BLANC / WHITE	350mm	85mm	55Lbs	1.2mm	10
658B - 85 - 16	BLANC / WHITE	400mm	85mm	55Lbs	1.2mm	10
658B - 85 - 18	BLANC / WHITE	450mm	95mm	55Lbs	1.2mm	10
658B - 85 - 20	BLANC / WHITE	500mm	102mm	55Lbs	1.2mm	10
658B - 85 - 22	BLANC / WHITE	550mm	110mm	55Lbs	1.2mm	10

AUTRES COULEURS DISPONIBLES SUR COMMANDE SPECIALE / OTHER COLORS ARE AVAILABLE ON SPECIAL ORDER

harn 4321

CÔTÉ DE TIROIR MÉTALLIQUE COULISSANT IMPAZ 117mm A/ GOUPILLE "PLUG-IN" 117mm IMPAZ SLIDING METAL DRAWER SIDE

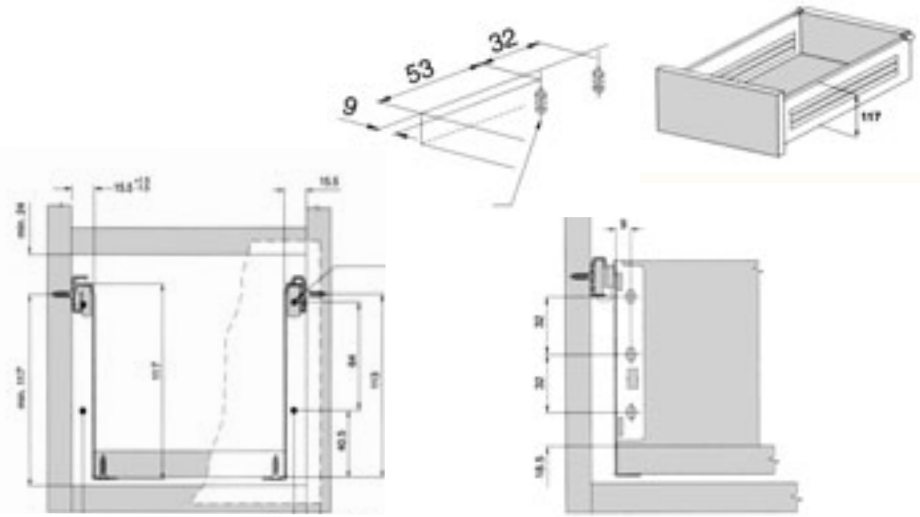
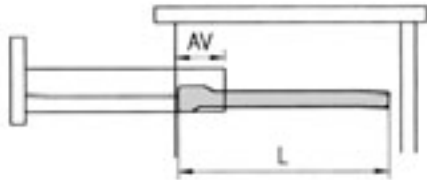

# QUINKO-TEK	COULEUR COLOR	LONGUEUR LENGTH	AV	CAPACITÉ CAPACITY	ÉPAISSEUR THICKNESS	CAISSE (VRAC) (BULK) CASE
658B - 117 - 14	BLANC / WHITE	350mm	85mm	55Lbs	1.2mm	5
658B - 117 - 16	BLANC / WHITE	400mm	85mm	55Lbs	1.2mm	5
658B - 117 - 18	BLANC / WHITE	450mm	95mm	55Lbs	1.2mm	5
658B - 117 - 20	BLANC / WHITE	500mm	102mm	55Lbs	1.2mm	5
658B - 117 - 22	BLANC / WHITE	550mm	110mm	55Lbs	1.2mm	5

AUTRES COULEURS DISPONIBLES SUR COMMANDE SPECIALE / OTHER COLORS ARE AVAILABLE ON SPECIAL ORDER

harn 4621

CÔTÉ DE TIROIR MÉTALLIQUE COULISSANT IMPAZ 149mm A/ GOUPILLE "PLUG-IN" 149mm IMPAZ SLIDING METAL DRAWER SIDE

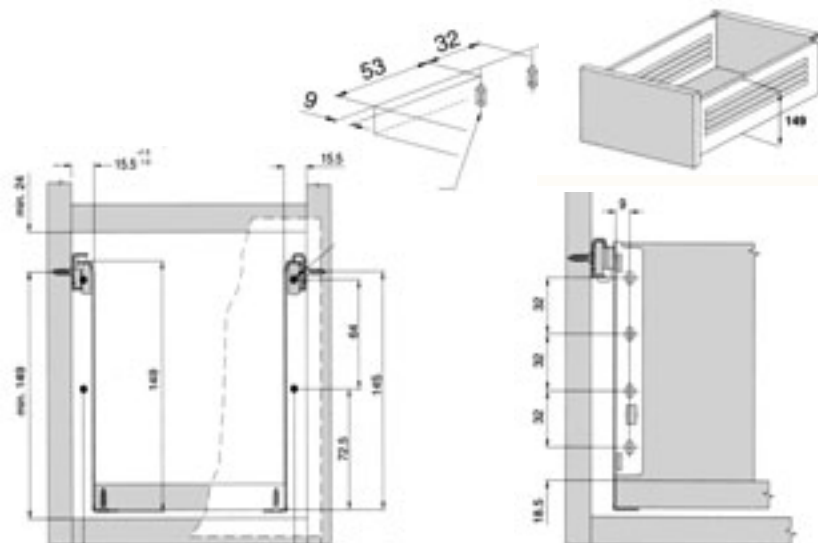
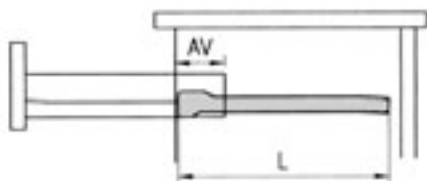

# QUINKO-TEK	COULEUR COLOR	LONGUEUR LENGTH	AV	CAPACITÉ CAPACITY	ÉPAISSEUR THICKNESS	CAISSE (VRAC) (BULK) CASE
658B - 149 - 14	BLANC / WHITE	350mm	85mm	55Lbs	1.2mm	5
658B - 149 - 16	BLANC / WHITE	400mm	85mm	55Lbs	1.2mm	5
658B - 149 - 18	BLANC / WHITE	450mm	95mm	55Lbs	1.2mm	5
658B - 149 - 20	BLANC / WHITE	500mm	102mm	55Lbs	1.2mm	5
658B - 149 - 22	BLANC / WHITE	550mm	110mm	55Lbs	1.2mm	5

AUTRES COULEURS DISPONIBLES SUR COMMANDE SPECIALE / OTHER COLORS ARE AVAILABLE ON SPECIAL ORDER

WATERLOO 4990 3/4 EXTENSION 75 lbs

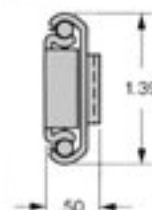

# QUINKO-TEK	# WATERLOO	LONGUEUR LENGTH	FINI FINISH	PERTE DE VOYAGEMENT LOSS OF TRAVEL DISTANCE	CAISSE CASE
610Z - 14	4990B - 14Z	350mm	ZINC	85.86mm	10
610Z - 16	4990B - 16Z	400mm	ZINC	98.55mm	10
610Z - 18	4990B - 18Z	450mm	ZINC	111.26mm	10
610Z - 20	4990B - 20Z	500mm	ZINC	123.95mm	10
610Z - 22	4990B - 22Z	550mm	ZINC	136.65mm	10

WATERLOO V40 PLEINE EXTENSION 90 lbs

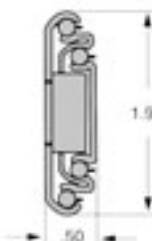

# QUINKO-TEK	# WATERLOO	LONGUEUR LENGTH	FINI FINISH	SURPASSEMENT OVERTRAVEL	CAISSE CASE
611Z - 12	V40B - 12Z	300mm	ZINC / ZINC	1"	10
611N - 12	V40B - 12B	300mm	NOIR / BLACK	1"	10
611Z - 14	V40B - 14Z	350mm	ZINC / ZINC	1"	10
611N - 14	V40B - 14B	350mm	NOIR / BLACK	1"	10
611Z - 16	V40B - 16Z	400mm	ZINC / ZINC	1"	10
611N - 16	V40B - 16B	400mm	NOIR / BLACK	1"	10
611Z - 18	V40B - 18Z	450mm	ZINC / ZINC	1"	10
611N - 18	V40B - 18B	450mm	NOIR / BLACK	1"	10
611Z - 20	V40B - 20Z	500mm	ZINC / ZINC	1"	10
611N - 20	V40B - 20B	500mm	NOIR / BLACK	1"	10
611Z - 22	V40B - 22Z	550mm	ZINC / ZINC	1"	10
611N - 22	V40B - 22B	550mm	NOIR / BLACK	1"	10

WATERLOO 3290 PLEINE EXTENSION 120 lbs

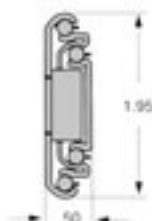

# QUINKO-TEK	# WATERLOO	LONGUEUR LENGTH	FINI FINISH	SURPASSEMENT OVERTRAVEL	CAISSE CASE
612Z - 12	3290B12Z	300mm	ZINC	5/8"	10
612Z - 14	3290B14Z	350mm	ZINC	5/8"	10
612Z - 16	3290B16Z	400mm	ZINC	5/8"	10
612Z - 18	3290B18Z	450mm	ZINC	5/8"	10
612Z - 20	3290B20Z	500mm	ZINC	5/8"	10
612Z - 22	3290B22Z	550mm	ZINC	5/8"	10
611Z - 24	3290B24Z	600mm	ZINC	5/8"	10
611Z - 26	3290B26Z	650mm	ZINC	5/8"	10
611Z - 28	3290B28Z	700mm	ZINC	5/8"	10

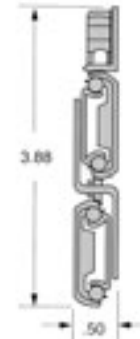
WATERLOO 4050 **PLEINE EXTENSION** **150 lbs**
FULL EXTENSION

# QUINKO-TEK	# WATERLOO	LONGUEUR LENGTH	FINI FINISH	SURPASSEMENT OVERTRAVEL	QUANTITÉ PACKING
615Z - 14	4050B14Z	350mm	ZINC / ZINC	1"	5
615N - 14	4050B14B	350mm	NOIR / BLACK	1"	5
615Z - 16	4050B16Z	400mm	ZINC / ZINC	1"	5
615N - 16	4050B16B	400mm	NOIR / BLACK	1"	5
615Z - 18	4050B18Z	450mm	ZINC / ZINC	1"	5
615N - 18	4050B18B	450mm	NOIR / BLACK	1"	5
615Z - 20	4050B20Z	500mm	ZINC / ZINC	1"	5
615N - 20	4050B20B	500mm	NOIR / BLACK	1"	5
615Z - 22	4050B22Z	550mm	ZINC / ZINC	1"	5
615N - 22	4050B22B	550mm	NOIR / BLACK	1"	5

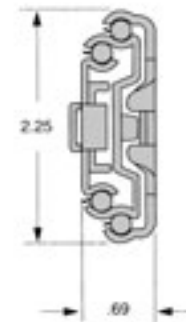
WATERLOO 3583 **PLEINE EXTENSION** **200 lbs**
FULL EXTENSION

# QUINKO-TEK	# WATERLOO	LONGUEUR LENGTH	FINI FINISH	SURPASSEMENT OVERTRAVEL	QUANTITÉ PACKING
3583 - 16	3583B16Z	400mm	ZINC	2.69"	5
3583 - 18	3583B18Z	450mm	ZINC	2.38"	5
3583 - 20	3583B20Z	500mm	ZINC	2"	5

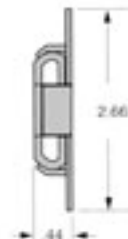
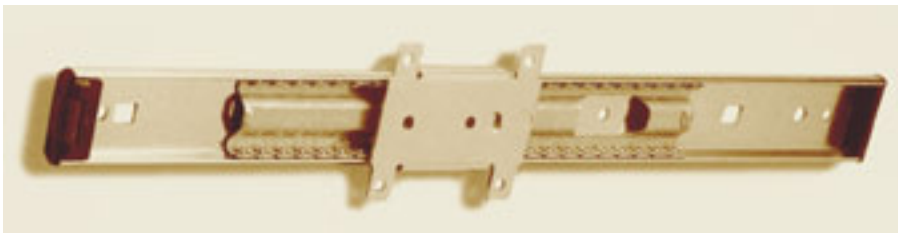
WATERLOO 4845 **COULISSE PORTE RETRACTABLE**
POCKET DOOR SLIDE

# QUINKO-TEK	# WATERLOO	LONGUEUR LENGTH	FINI FINISH	SURPASSEMENT OVERTRAVEL	QUANTITÉ PACKING
616Z - 16	48451600M	400mm	ZINC	-	20
616Z - 18	48451800M	450mm	ZINC	-	20
616Z - 20	48452000M	500mm	ZINC	-	20

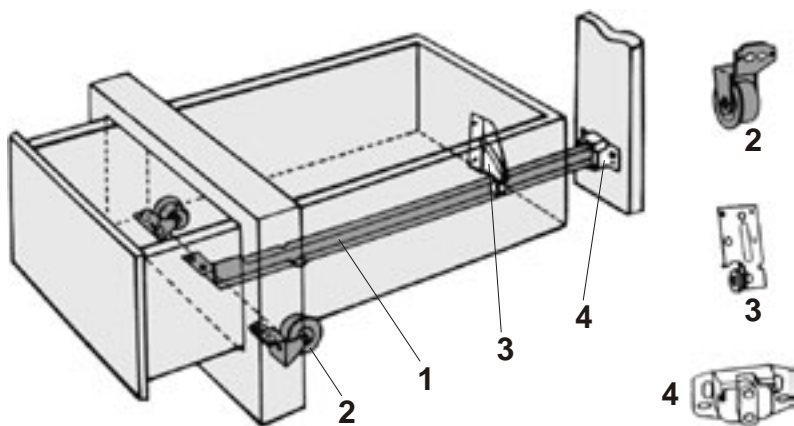
COULISSES TRADITIONNELLES / TRADITIONAL SLIDES

#	# QUINKO-TEK	DESCRIPTION	CAISSE CASE
1	S0640-22 5/8	COULISSE CENTRALE 22 5/8 CENTRAL SLIDE 22 5/8	100
2	S0641-JR	ROULEAU (2MCX) ROLLER (2PCS)	100
3	S0642-RC	GUIDE CENTRAL CENTER GUIDE	100
4	S0643-SA	SUPPORT ARRIÈRE REAR SOCKET	100

CES ITEMS PEUVENT ÊTRE COMMANDÉS EMBALLÉS INDIVIDUELLEMENT OU EN ENSEMBLE EMPAQUETÉ

ITEMS MAY BE ORDERED INDIVIDUALLY OR PACKAGED AS A FULL KIT

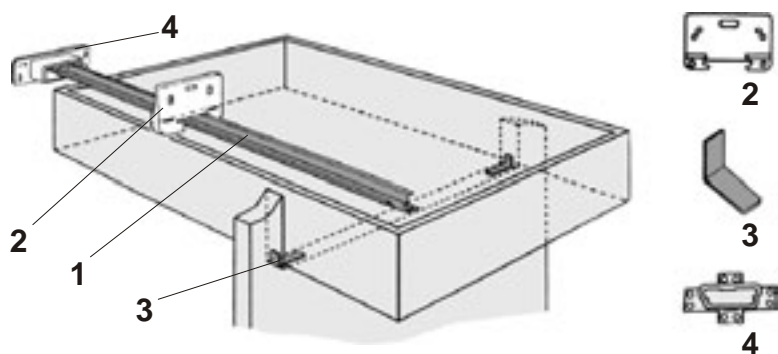

1	S0644-22 5/8	COULISSE CENTRALE 22 5/8 CENTRAL SLIDE 22 5/8	100
2	S0645-SC	GUIDE CENTRAL CENTER GUIDE	100
3	S0647-GD	GUIDE DE CÔTÉ (2MCX) SLIDE CORNER GUIDE (2PCS)	100
4	S0646-SA	SUPPORT ARRIÈRE REAR SOCKET	100

CES ITEMS PEUVENT ÊTRE COMMANDÉS EMBALLÉS INDIVIDUELLEMENT OU EN ENSEMBLE EMPAQUETÉ

ITEMS MAY BE ORDERED INDIVIDUALLY OR PACKAGED AS A FULL KIT

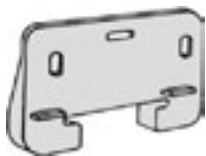

1	O129-BL	GUIDE CENTRAL POUR COULISSE DE BOIS CENTRAL GUIDE FOR WOOD SLIDE BLANC / WHITE	1,000
---	---------	--	-------

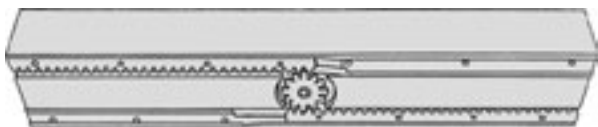

1	0613-BS	OUVERTURE / OPENING = 25" DIM. 2 3/8" x 25 1/2"	1
1	0614-BS	OUVERTURE / OPENING = 37" DIM. 2 3/8 x 37 1/2"	1

COULISSE DE TABLE EN BOIS AVEC CRÉMAILLIÈRE EN ACIER
DOUBLE ACTION WOOD TABLE SLIDE WITH STEEL GEAR

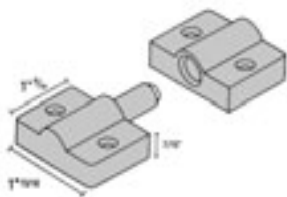

		COULEUR COLOR	
1	0125 - BR	BRUN / BROWN	250

NIVELEUR DE TABLE
TABLE LEVELLER

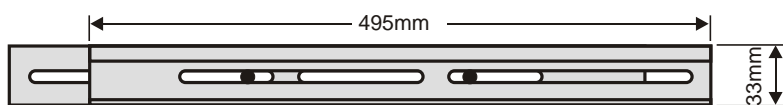

1	0615 - PL	OUVERTURE / OPENING 350mm	1
---	-----------	------------------------------	---

COULISSE DE TABLE MÉTALLIQUE
DOUBLE ACTION STEEL TABLE SLIDE

QUINCAILLERIE POUR PORTES COULISSANTES
SLIDING DOOR HARDWARE

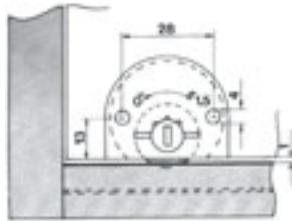

# QUINKO-TEK	COULEUR COLOR	CAISSE CASE
161A - BR	BRUN / BROWN	250

Roulement ajustable pour portes coulissantes
Adjustable roller for sliding door

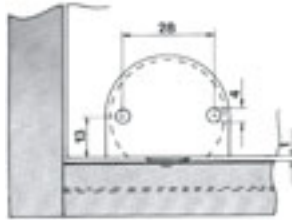

0161 - BR	BRUN / BROWN	250
-----------	--------------	-----

Roulement pour portes coulissantes
Roller for sliding door

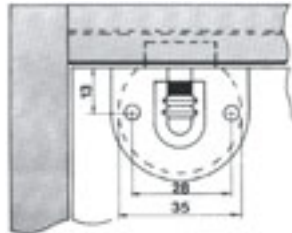
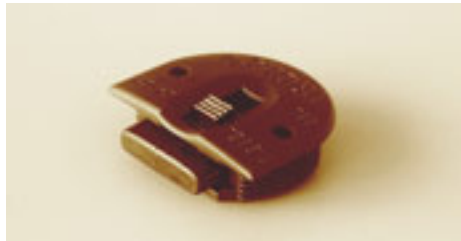

0162 - BR	BRUN / BROWN	250
-----------	--------------	-----

Guide du haut pour portes coulissantes
Top guide for sliding door

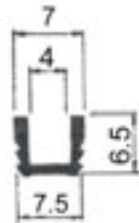

0163 - NR	NOIR / BLACK	100
-----------	--------------	-----

Rail de bas pour système de portes coulissantes 10'
Bottom rail sliding door system 10'



0164 - NR	NOIR / BLACK	100
-----------	--------------	-----

Rail de haut pour système de portes coulissantes 10'
Top rail sliding door system 10'

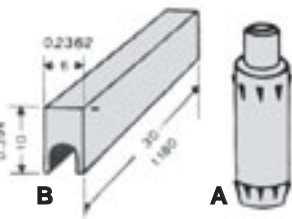
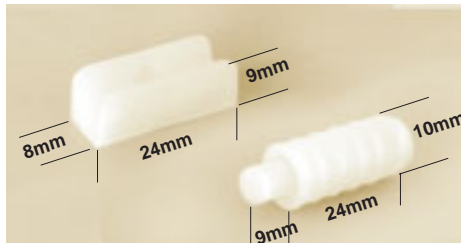

A 0122 - NT	BLANC / WHITE	100
B 0199 - NT	BLANC / WHITE	100

A Guide haut de portes coulissantes / Top guide
B Sabot de portes coulissantes / Bottom guide



0147 - NR	NOIR / BLACK	150
-----------	--------------	-----

Coulisses pour portes coulissantes, rouleau 150'
Sliding door rail, roll 150'

QUINCAILLERIE PORTES COULISSANTES
SLIDING DOOR HARDWARE



# QUINKO-TEK	COULEUR COLOR	CAISSE CASE
KROLL25 - NR	NOIR / BLACK	10

Ensemble de roulement Roll-25 pour porte min. 5/8" (25 kg capacité) inclus
2 guides + 2 roulement bas.
*Roll-25 hardware set for minimum 5/8" doors 25 kg capacity
(2 head guides + 2 bottom rollers).*

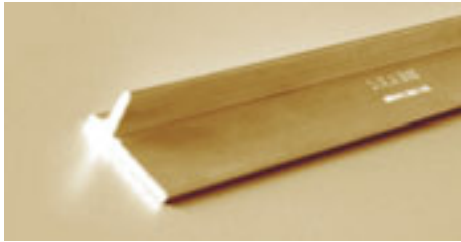

KTROLL25 - 6M	ANODISE / ANODIZED	6m
---------------	--------------------	----

Rail de haut et bas en aluminium pour Roll-25 (6 mètres).
Aluminum upper and bottom tracks for Roll-25 (6 meters).



KK30 - ZC	ZINC / ZINC	10
-----------	-------------	----

Ensemble de roulement K30 pour portes coulissantes. Capacité de 30 kg
(2 roulements + 1 guide).
K30 hardware set for sliding doors 30 kg capacity (2 rollers + 1 guide).

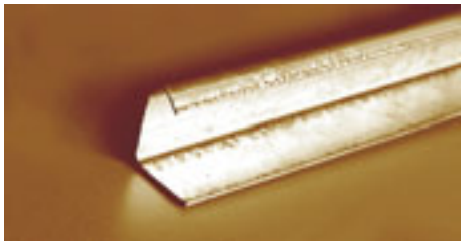



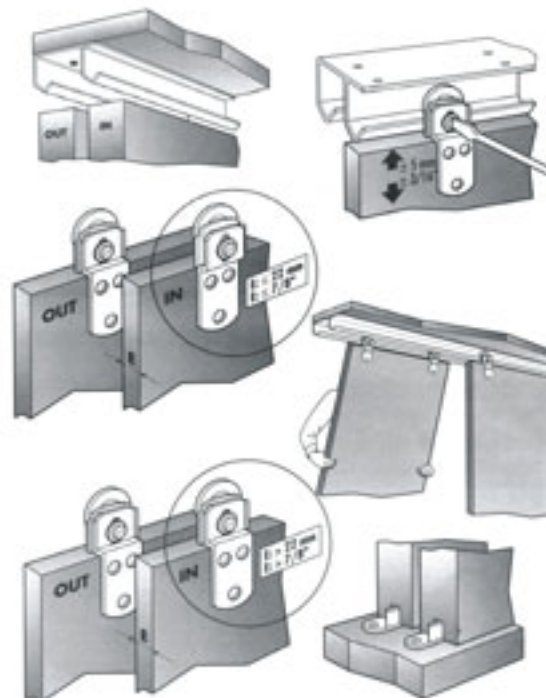
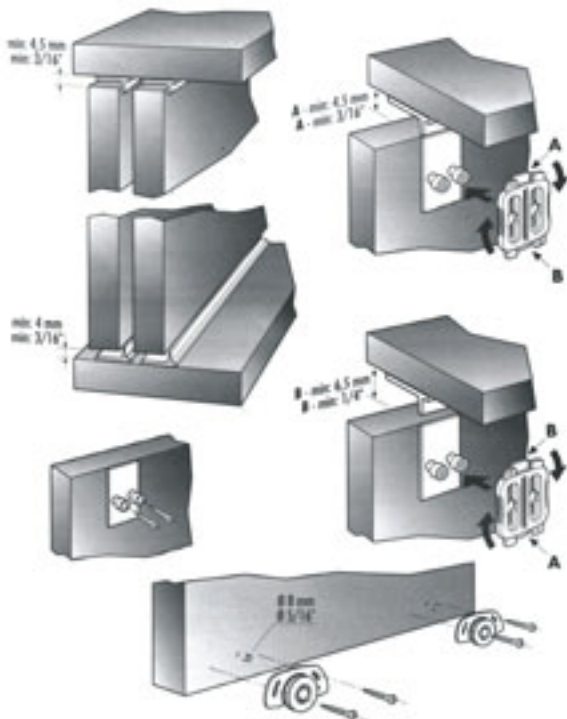

KTK30 - 6M	ACIER / STEEL	6m
------------	---------------	----

Rail de haut pour système k30 (6 MÈTRES).
Upper rail for K30 system (6 meters).

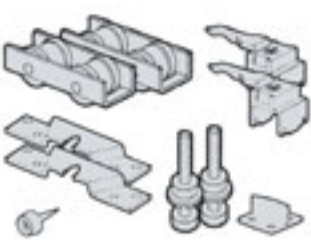

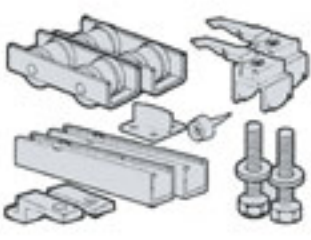
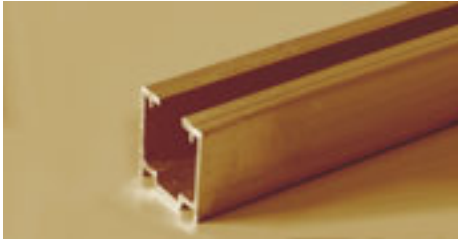
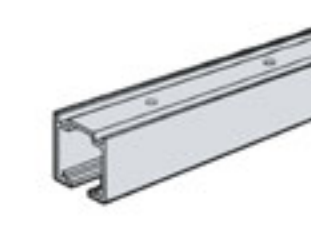

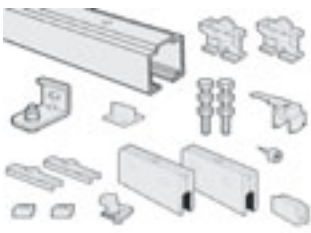

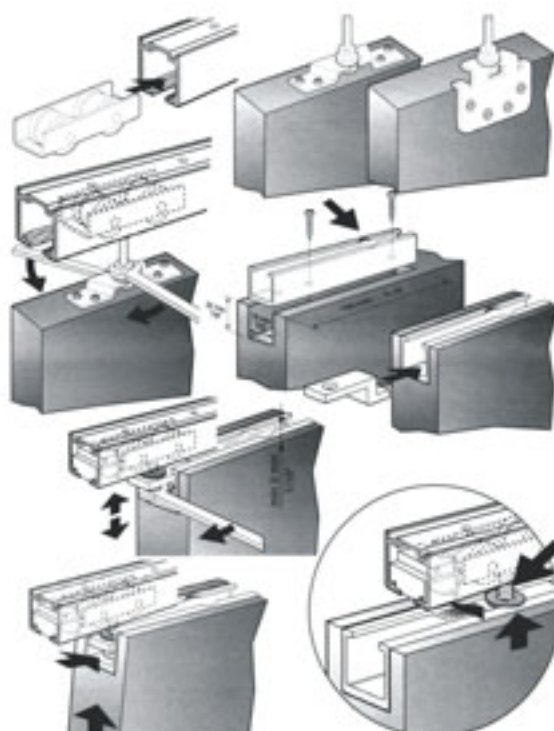
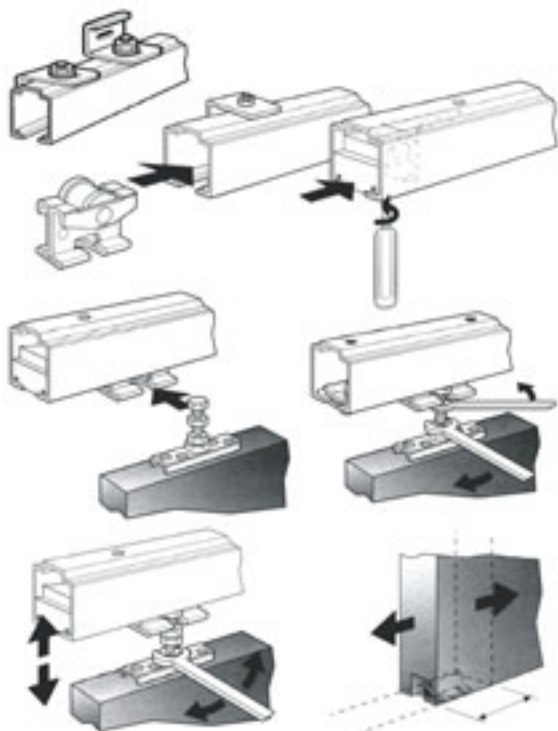

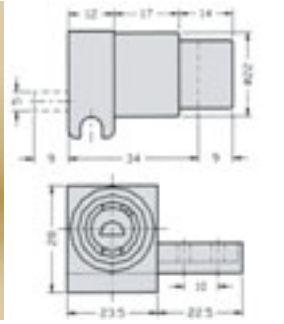

QUINCAILLERIE PORTES COULISSANTES / SLIDING DOOR HARDWARE

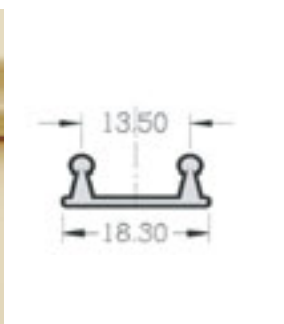

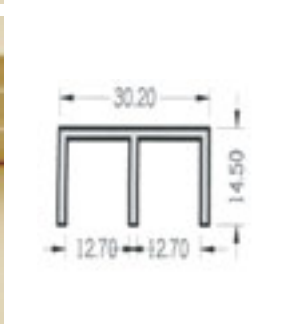
		# QUINKO-TEK	FINI FINISH	CAISSE CASE
		KSLID60 - 22	ZINC / ZINC	1
Ensemble de quincaillerie pour système Slid 60 (capacité 60 kgs). Fixation en surface (1 ensemble roul. - 1 porte + stopper et guide). <i>Hardware set for Slid 60 system (60 kg capacity)</i> <i>Surface hardware installation (roller set for 1 door + guide).</i>				
		KSLID60 - 23	ZINC / ZINC	1
Ensemble de quincaillerie pour système Slid 60 (capacité 60 kgs). Fixation encastrée (1 ensemble roul. - 1 porte + stopper et guide). <i>Hardware set for Slid 60 system (60 kg capacity)</i> <i>Mortise hardware installation (roller set for 1 door + guide).</i>				
		KTSLID60 - 2M KTSLID60 - 3M	ANODISE / ANODIZED	2 m 3 m
Rail pour système Slid 60 (2 ou 3 mètres). <i>Slid 60 top rail (2 or 3 meters).</i>				
		KNK45 - ZC	ZINC / ZINC	1
Ensemble de roulement Nk45 (capacité 45 kg) inclus Quincaillerie pour 1 porte + 1 rail haut de 1.6 mètres <i>Nk45 hardware set for sliding door (45 kg capacity)</i> <i>Hardware for 1 door + 1.6 meter upper rail</i>				

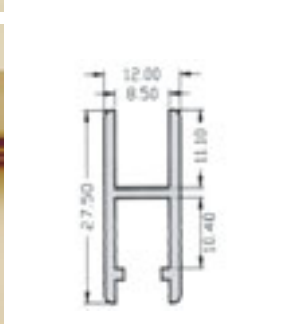

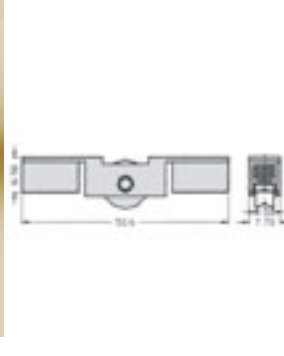
QUINCAILLERIE POUR PORTES COULISSANTES
SLIDING DOOR HARDWARE

		# QUINKO-TEK	FINI FINISH	DESCRIPTION	CAISSE CASE
		35860 - CH	CHROME / CHROME	Boîtier serrure poussoir pour système de portes coulissantes installation sur moulure # 35005 - AL <i>Push lock housing for sliding door system Installation on moulding # 35005 - AL</i>	20
		35005 - AL	ALUMINIUM / ALUMINUM	Moulure de bas pour système porte de verre coulissante, 2 mètres longueur <i>Bottom track for sliding glass door system, 2 meter length</i>	100
		350058 - AL	ALUMINIUM / ALUMINUM	Moulure de haut pour système porte de verre coulissante, 2 mètres longueur <i>Top track for sliding glass door system, 2 meter length</i>	50
		350059 - AL	ALUMINIUM / ALUMINUM	Moulure pour porte verre pour système porte coulissante, 2 mètres longueur <i>Glass rail for sliding glass door system, 2 meter length</i>	50
		350060 - ZC	ZINC / ZINC	Roulettes pour moulure de porte 350059 - AL <i>Roller for moulding 350059 - AL</i>	150

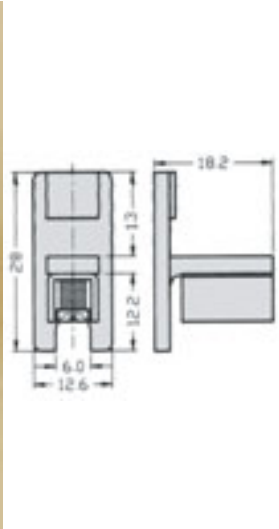
QUINCAILLERIE POUR PORTES COULISSANTES
SLIDING DOOR HARDWARE

		# QUINKO-TEK	FINI FINISH	DESCRIPTION	CAISSE CASE
		350061 - CH	CHROME / CHROME	Embouts de finition pour moulure # 350059 - AL <i>End cap for moulding # 350059 - AL</i>	250
		350062 - GR	GRIS / GRAY	Moulure pour verre pied lineaire <i>Glass moulding linear foot</i>	325
		350063 - CL		Amortisseur pour porte de verre <i>Silencer for glass door</i>	500

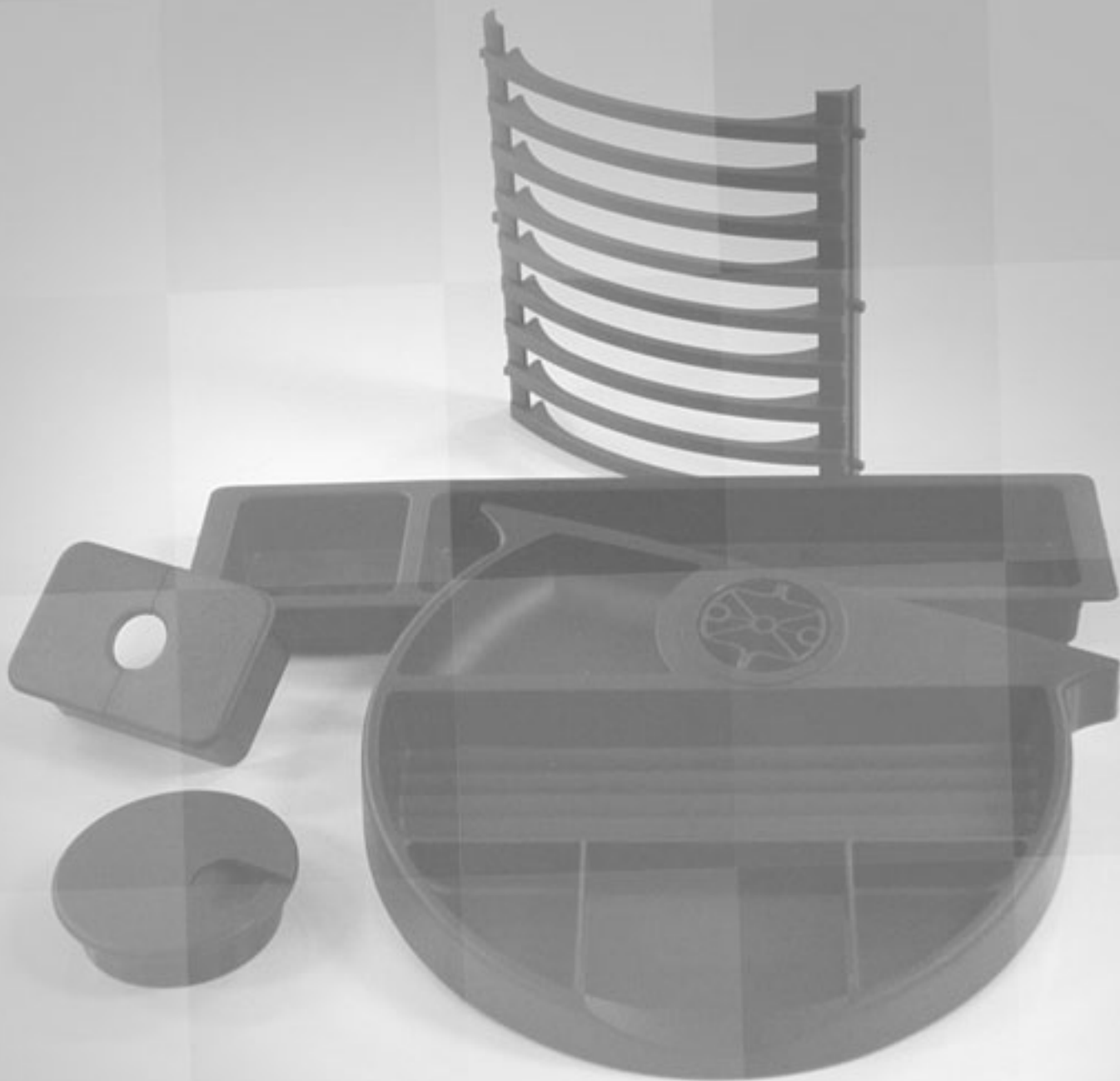

Spectrum 310 - 320

Système de rangement multimedia universel Universal multimedia storage system

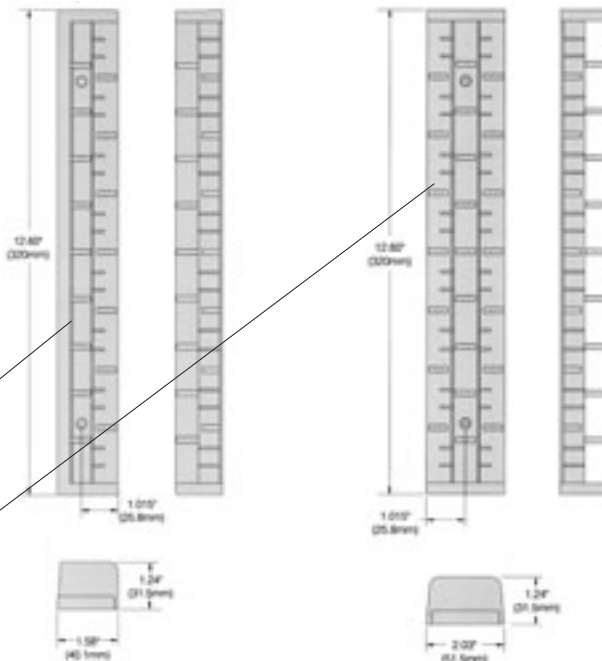
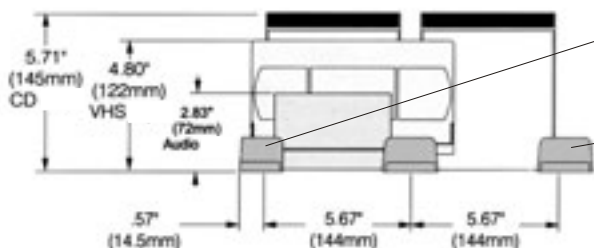
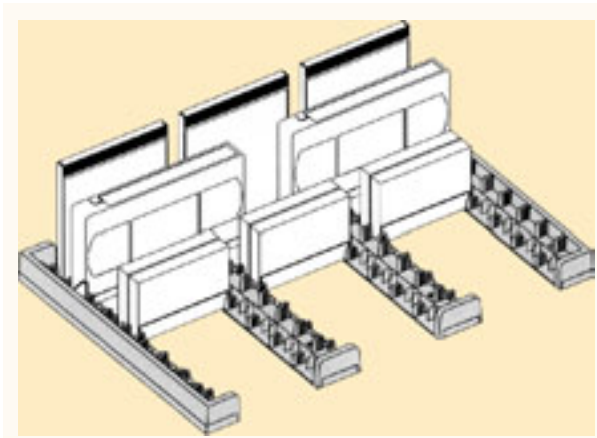

#	# QUINKO-TEK	# SPECTRUM	DESCRIPTION	DIMENSION		COULEUR COLOR	CAPACITÉ / CAPACITY						CAISSE CASE
				longueur length	largeur width		DVD	CD	DOUBLE CD	VHS TAPE	AUDIO TAPE	3 1/2" DISKETTE	
1	628N - UL	310	rail extérieur / exterior rail	320mm	40.1mm	NOIR / BLACK	-	24	7	10	16	-	100
2	628N - CR	320	rail central / center rail	320mm	51.5mm	NOIR / BLACK	-	24	7	10	16	-	100

Spectrum 330

Système de rangement simple universel Single universal storage system

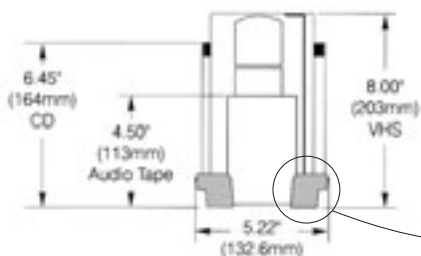
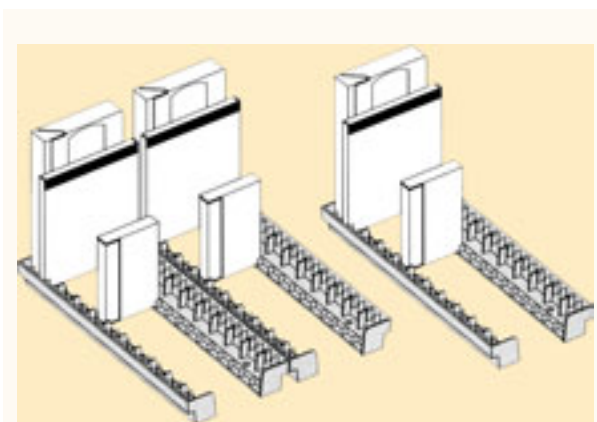

LE 630N-UL EST UN SYSTÈME CONÇU SPÉCIALEMENT POUR DES APPLICATIONS DE RANGÉES SIMPLES. IL PEUT ÊTRE POSÉ SUR UNE TABLETTE FIXE OU COULISSANTE.

THE 630N-UL IS A SYSTEM THAT IS DESIGNED ESPECIALLY FOR SINGLE ROW APPLICATIONS. IT CAN BE USED ON A SLIDING OR FIXED SHELF.

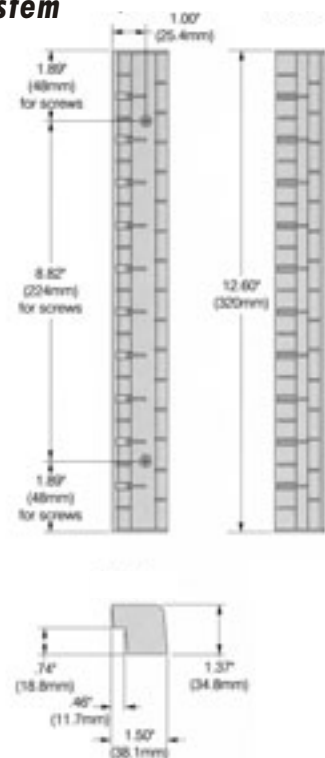

#	# QUINKO-TEK	# SPECTRUM	DESCRIPTION	DIMENSION		COULEUR COLOR	CAPACITÉ / CAPACITY						CAISSE CASE
				longueur length	largeur width		DVD	CD	DOUBLE CD	VHS TAPE	AUDIO TAPE	3 1/2" DISKETTE	
1	630N - UL	330	rail universel / universal rail	224mm	38.1mm	NOIR / BLACK	-	22	-	11	16	-	100

Spectrum 331 - 334

RAILS - ECONO

Flipworks™

Système de rangement Storage system

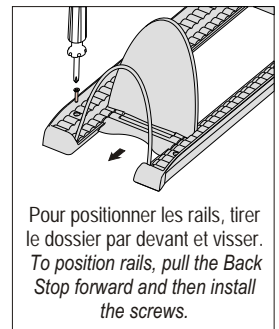
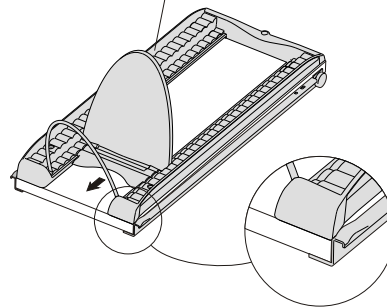
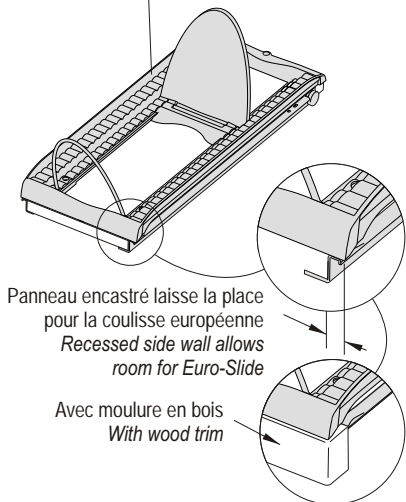
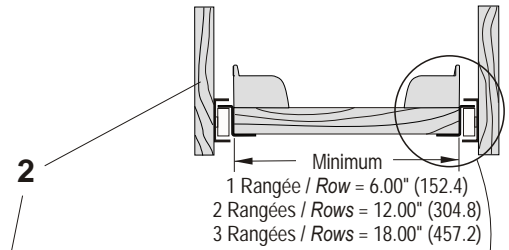
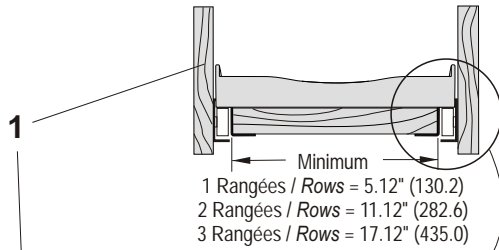
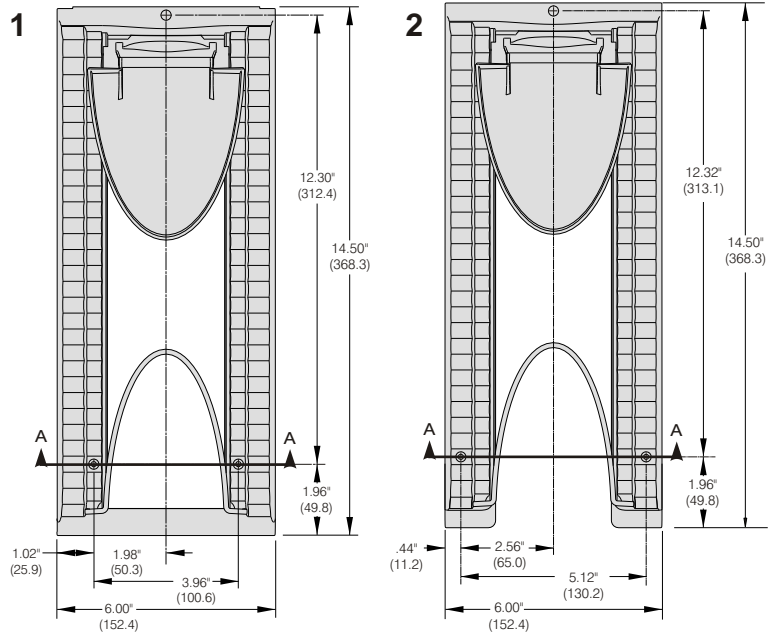
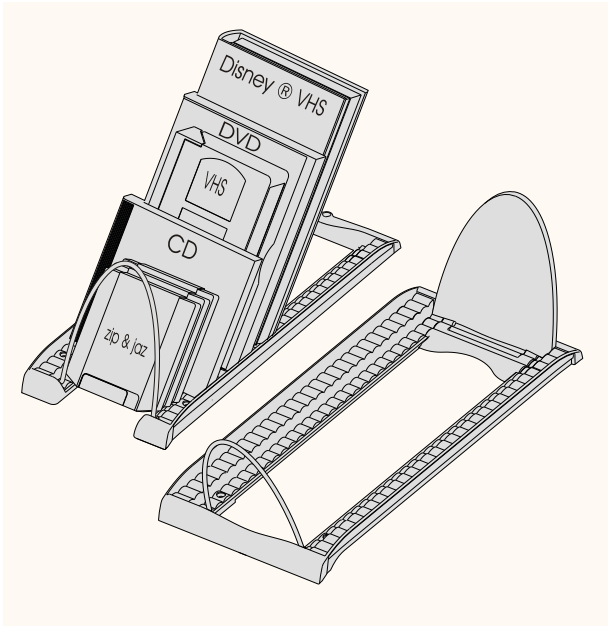

#	# QUINKO-TEK	# SPECTRUM	DESCRIPTION	DIMENSION		COULEUR COLOR	CAISSE CASE
				longueur length	largeur width		
1	641N - AD	334	Plateau Flipworks™ avec devanture / Flipworks™ tray with closed front	368.3mm	152.4mm	NOIR / BLACK	40
2	641N - SD	331	Plateau Flipworks™ sans devanture / Flipworks™ tray with open front	368.3mm	152.4mm	NOIR / BLACK	40

Spectrum 372

Système de rangement multimedia universel Universal multimedia storage system

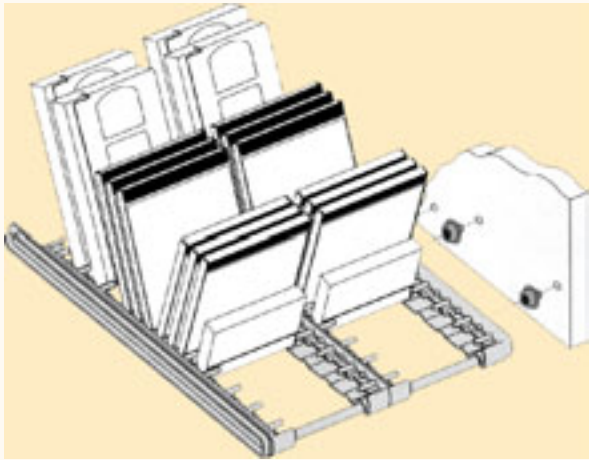

LE 637N -ST EST UN SYSTÈME CONÇU SPÉCIALEMENT POUR DES APPLICATIONS DE RANGÉES SIMPLES OU MULTIPLES. IL PEUT ÊTRE POSÉ SUR UN SYSTÈME DE ROULETTES OU DE RAINURES.

THE 637 - ST IS A SYSTEM THAT IS DESIGNED ESPECIALLY FOR SINGLE AND MULTIPLE ROW APPLICATIONS. IT CAN BE INSTALLED WITH PLASTIC ROLLER OR GROOVE APPLICATION.

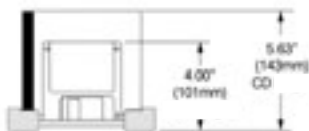
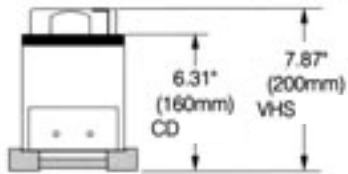
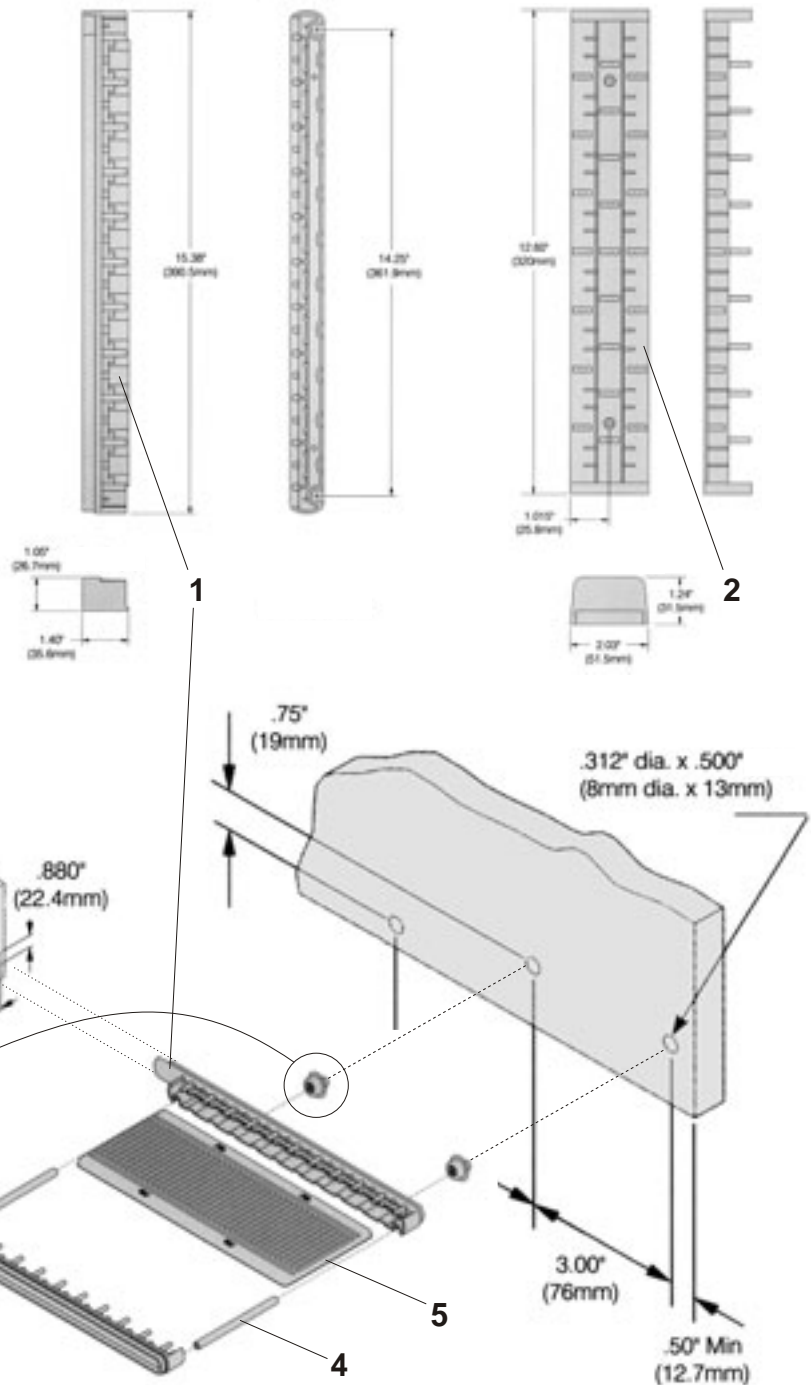

#	# QUINKO-TEK	# SPECTRUM	DESCRIPTION	DIMENSION		COULEUR COLOR	CAPACITÉ / CAPACITY					CAISSE CASE	
				longueur length	largeur width		DVD	CD	DOUBLE CD	VHS TAPE	AUDIO TAPE		3 1/2" DISKETTE
1	637N - ST	372	rail extérieur / exterior rail	390.5mm	35.6mm	NOIR / BLACK	-	22	-	10	10	-	50
2	638N - CR	362	rail central / center rail	390.5mm	49mm	NOIR / BLACK	-	22	-	10	10	-	100
3	0690 - NR	190	roulette plastique / plastic roller	-	-	NOIR / BLACK	-	-	-	-	-	-	4,000
4	638N - 05	T2 - 5.12	tube plastique / plastic tube	5.12"	-	NOIR / BLACK	-	-	-	-	-	-	500
4	638N - 5 3/8	T2 - 5.37	tube plastique / plastic tube	5.38"	-	NOIR / BLACK	-	-	-	-	-	-	500
4	638N - 15.56	T1 - 15.56	tube aluminium / aluminum tube	15.56"	-	NOIR / BLACK	-	-	-	-	-	-	100
4	638N - 17	T1 - 17	tube aluminium / aluminum tube	17"	-	NOIR / BLACK	-	-	-	-	-	-	100
4	638PN - 72	T2 - 72	tube plastique / plastic tube	72"	-	NOIR / BLACK	-	-	-	-	-	-	100
4	638N - 72	T1 - 72	tube aluminium / aluminum tube	72"	-	NOIR / BLACK	-	-	-	-	-	-	100
5	638N - DI	416	adaptateur disq. / disk adapter	340mm	145mm	NOIR / BLACK	-	-	-	-	-	42	100

Spectrum 374

Flipworks™ EXPRESS Système de rangement Storage system

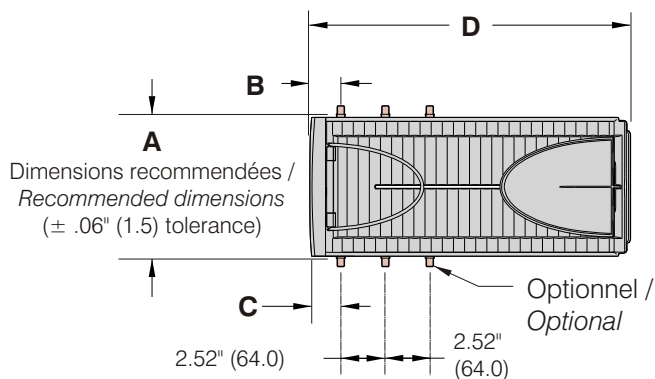
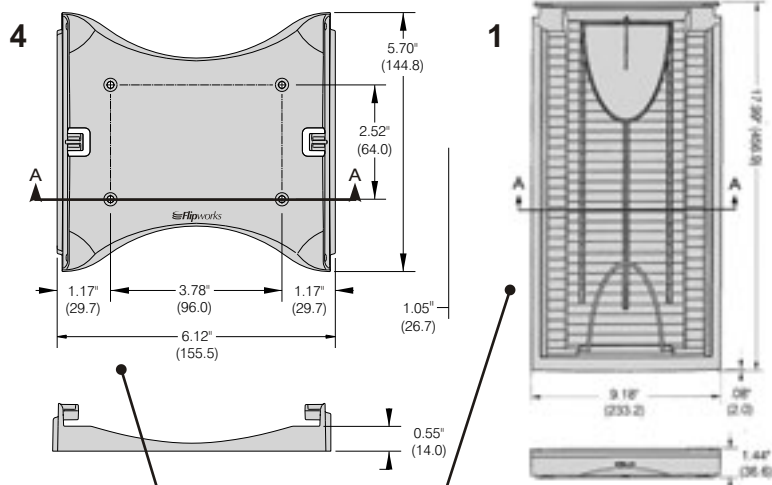
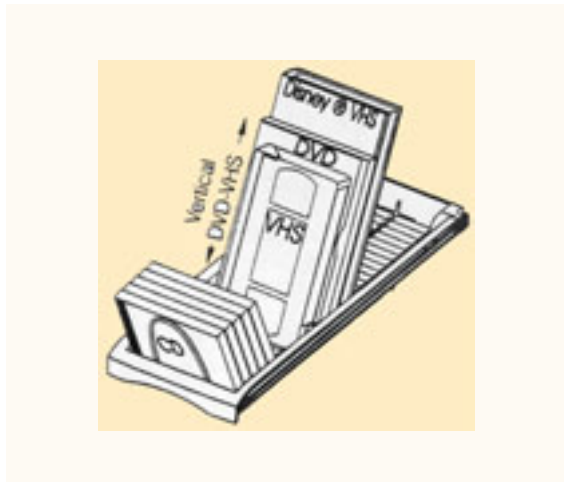

Dimensions recommandées / Recommended dimensions (± .06" (1.5) tolerance)

*	A	B	C	D
1	6.12" (155.4)	1.36" (34.5)	1.29" (32.8)	13.90" (353.1)
2	12.12" (307.8)	1.44" (36.6)	1.44" (36.6)	14.10" (358.1)
3	18.12" (460.2)	1.44" (36.6)	1.44" (36.6)	14.10" (358.1)

* Rangé / Row

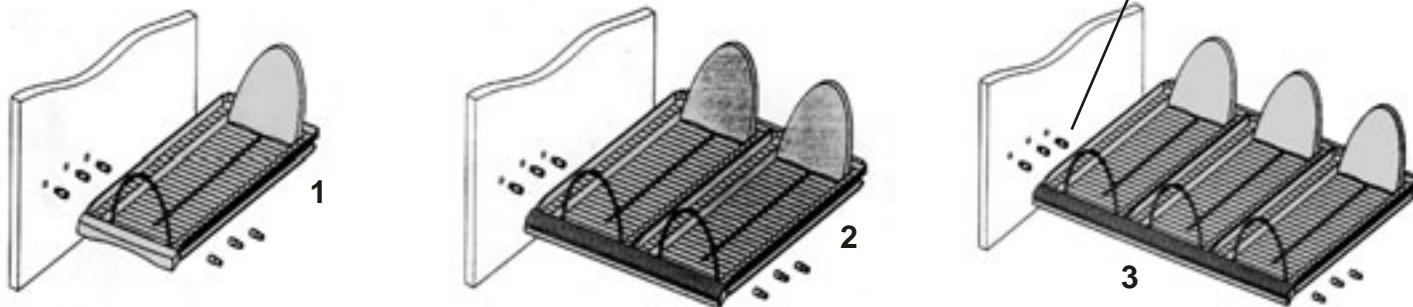
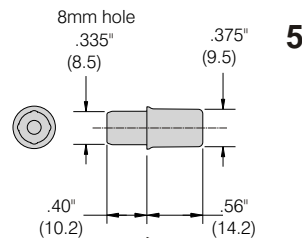
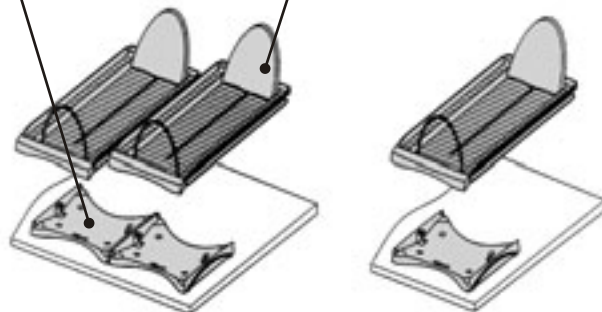

#	# QUINKO-TEK	# SPECTRUM	DESCRIPTION	DIMENSION		COULEUR COLOR	CAISSE CASE
				longueur length	largeur width		
1	646N1 - 14	374	Plateau Flipworks™ simple / Simple Flipworks™ tray	352.0mm	152.4mm	NOIR / BLACK	50
2	646N2 - 14	374 - 2R	Plateau Flipworks™ double / Double Flipworks™ tray	356.6mm	304.8mm	NOIR / BLACK	15
3	646N3 - 14	374 - 3R	Plateau Flipworks™ triple / Triple Flipworks™ tray	356.6mm	457.2mm	NOIR / BLACK	15
4	646N - CR	379	Base de montage / Surface mounting base	144.8mm	155.5mm	NOIR / BLACK	50
5	646N - PN	194	Goujons de glissement / Glide pins	24.4	8.5mm	NOIR / BLACK	300

Spectrum 381-386

Système de rangement multimedia universel Flipworks Flipworks universal multimedia storage system

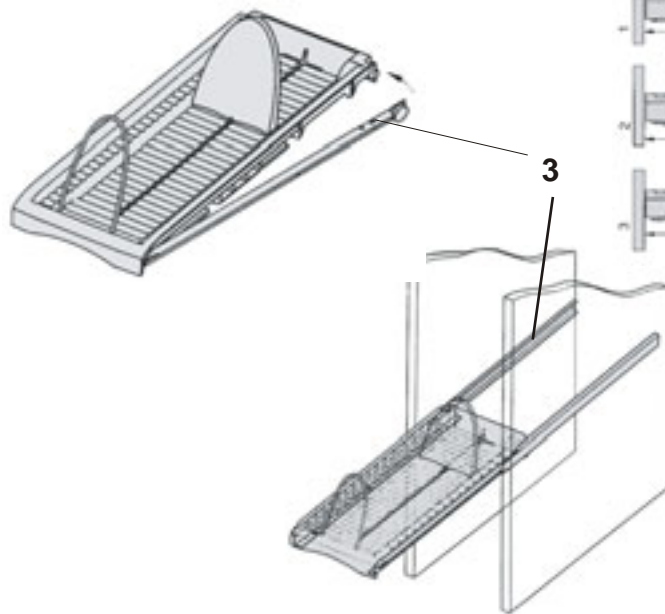
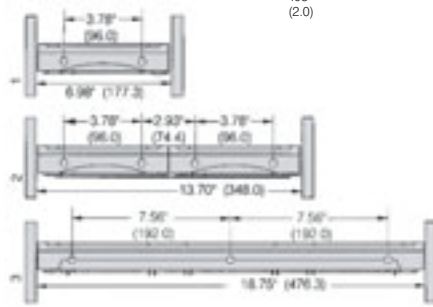
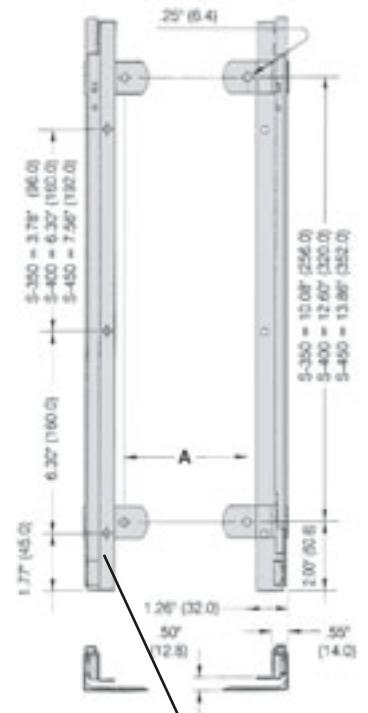
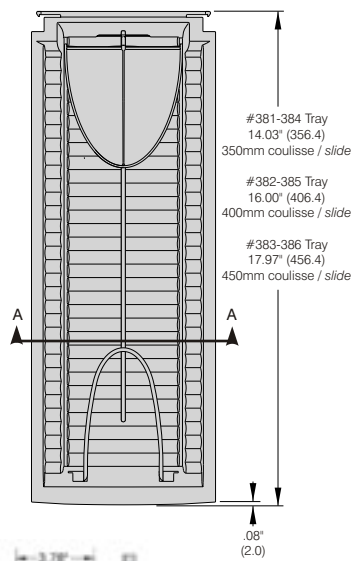
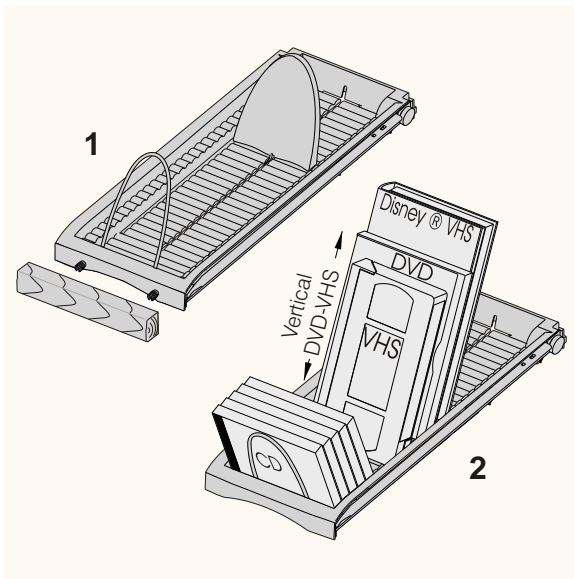

Façade à enfoncer / Stud facade

Façade courbée / Curved facade

#	# QUINKO-TEK	# SPECTRUM	DIMENSION		COULEUR COLOR	CAISSE CASE	#	# QUINKO-TEK	# SPECTRUM	DIMENSION		COULEUR COLOR	CAISSE CASE
			hauteur height	largeur width						hauteur height	largeur width		
1	642N - 14	381	354.4mm	170.7mm	NOIR / BLACK	40	2	641N - 14	384	356.4mm	170.7mm	NOIR / BLACK	40
1	642N - 16	382	404.4mm	170.7mm	NOIR / BLACK	40	2	641N - 16	385	406.4mm	170.7mm	NOIR / BLACK	40
1	642N - 18	383	454.4mm	170.7mm	NOIR / BLACK	30	2	641N - 18	386	456.4mm	170.7mm	NOIR / BLACK	30
1	642N2 - 14	381 - 2R	357.5mm	341.4mm	NOIR / BLACK	15	2	641N2 - 14	384 - 2R	363.6mm	341.4mm	NOIR / BLACK	15
1	642N2 - 16	382 - 2R	407.5mm	341.4mm	NOIR / BLACK	15	2	641N2 - 16	385 - 2R	413.6mm	341.4mm	NOIR / BLACK	15
1	642N2 - 18	383 - 2R	457.5mm	341.4mm	NOIR / BLACK	15	2	641N2 - 18	386 - 2R	463.6mm	341.4mm	NOIR / BLACK	15
1	642N3 - 14	381 - 3R	357.4mm	467.9mm	NOIR / BLACK	15	2	641N3 - 14	384 - 3R	367.3mm	467.9mm	NOIR / BLACK	15
1	642N3 - 16	382 - 3R	407.4mm	467.9mm	NOIR / BLACK	15	2	641N3 - 16	385 - 3R	417.3mm	467.9mm	NOIR / BLACK	15
1	642N3 - 18	383 - 3R	457.4mm	467.9mm	NOIR / BLACK	15	4	641N3 - 18	386 - 3R	467.3mm	467.9mm	NOIR / BLACK	15
3	650N - 14	-	350mm	-	NOIR / BLACK	100	4	645N - 14	S350	350mm	-	NOIR / BLACK	20
3	650N - 16	-	400mm	-	NOIR / BLACK	100	4	645N - 16	S400	400mm	-	NOIR / BLACK	20
3	650N - 18	-	450mm	-	NOIR / BLACK	100	4	645N - 18	S450	450mm	-	NOIR / BLACK	15

AUTRES COULEURS DISPONIBLES SUR COMMANDE SPÉCIALE / OTHER COLORS ARE AVAILABLE ON SPECIAL ORDER

Spectrum 396

PROFILE BAS - LOW PROFILE

Flipworks™

Système de rangement Storage system

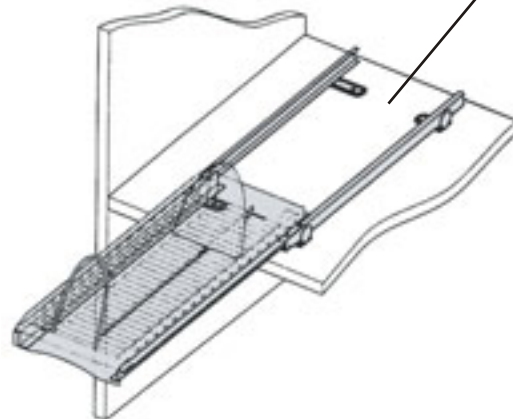
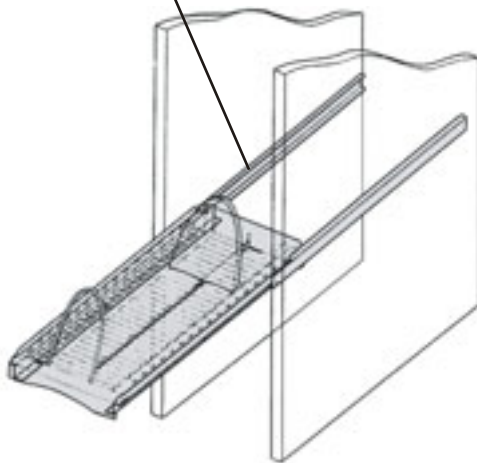
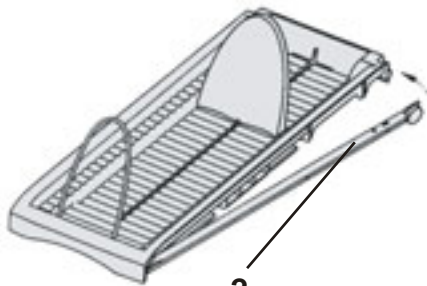
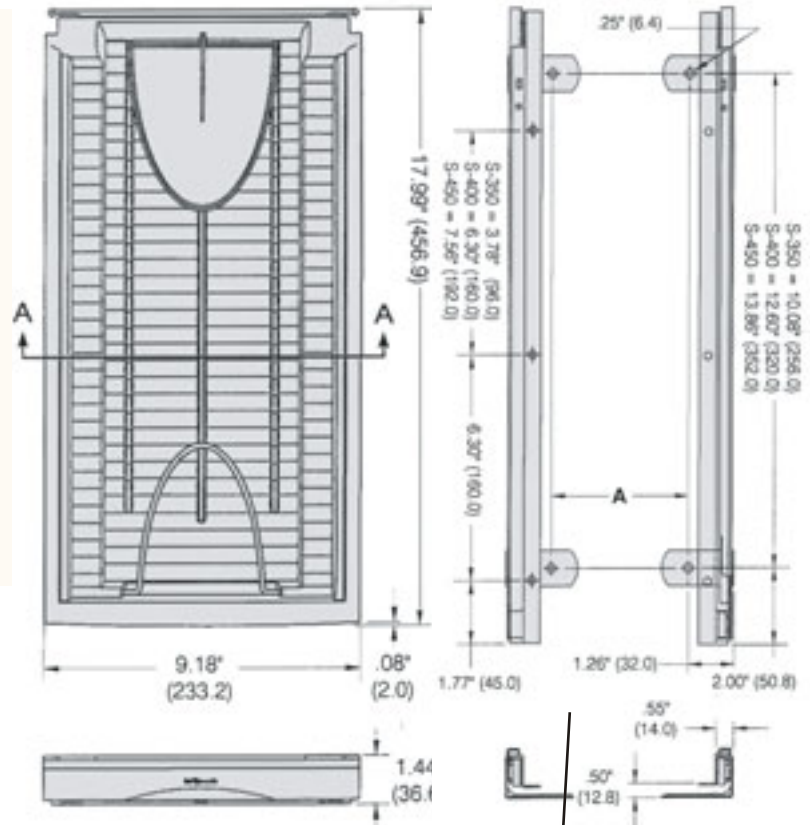
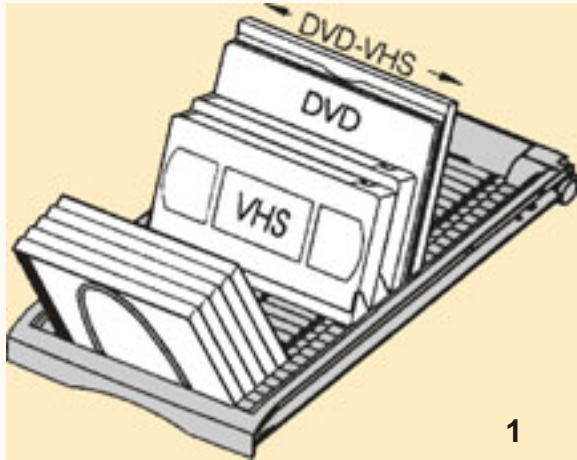

#	# QUINKO-TEK	# SPECTRUM	DESCRIPTION	DIMENSION		COULEUR COLOR	CAISSE CASE
				hauteur height	largeur width		
1	647N - 18	396	Plateau Flipwork Simple / Simple Flipwork Tray	456.9mm	233.2mm	NOIR / BLACK	12
1	647N2 - 18	396 - 2R	Plateau Flipwork Double / Double Flipwork Tray	461.3mm	466.3mm	NOIR / BLACK	12
1	647N3 - 18	396 - 3R	Plateau Flipwork Triple / Triple Flipwork Tray	461.3mm	699.6mm	NOIR / BLACK	12
2	650N - 18	-	Coulisse 450mm Noir / Black 450mm Slide	450mm	-	NOIR / BLACK	100
3	645N - 18	5450	Coulisse 450mm Noir A - Support / Black 450mm Slide W - Brakets	450mm	-	NOIR / BLACK	15

AUTRES COULEURS DISPONIBLES SUR COMMANDE SPÉCIALE / OTHER COLORS ARE AVAILABLE ON SPECIAL ORDER

Spectrum 420

Système de rangement Media Rack Media Rack storage system

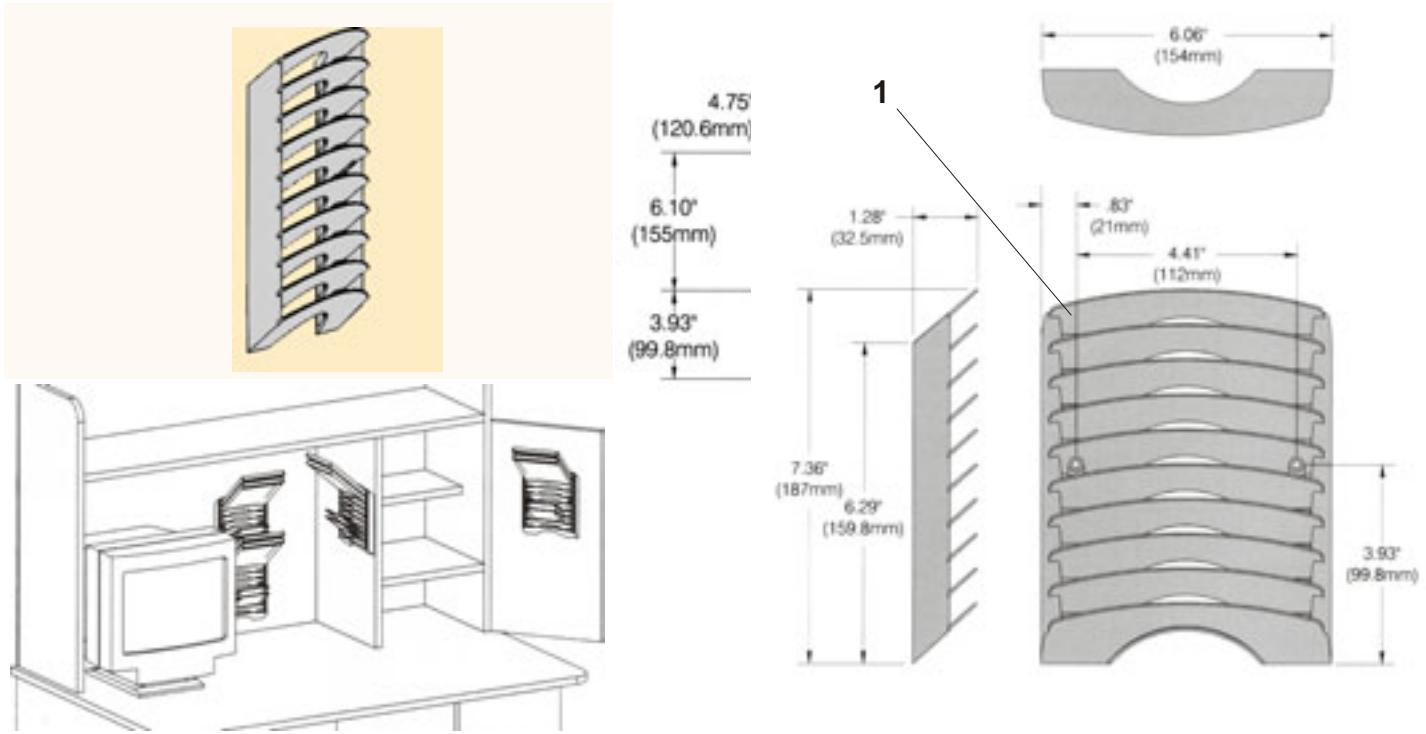

#	# QUINKO-TEK	# SPECTRUM	DESCRIPTION	DIMENSION		COULEUR COLOR	CAPACITÉ / CAPACITY						CAISSE CASE
				longueur length	largeur width		DVD	CD	DOUBLE CD	VHS TAPE	AUDIO TAPE	3 1/2" DISKETTE	
1	640N - DP	420	support CD / CD holder	187mm	154mm	NOIR / BLACK	-	9	-	-	-	27	96

Spectrum 440 - 490

Organisateur de bureau et tapis à souris Keyboard organizer and mouse pad

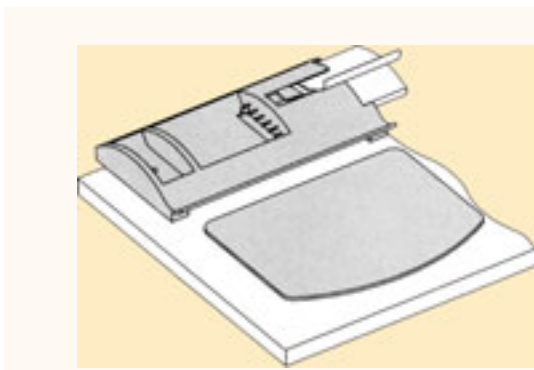

LE 636N-KO PEUT CONTENIR CINQ DISQUETTES 3.5", UNE TABLETTE DE PAPIERS AUTOCOLLANTS, DES TROMBONES, DES CRAYONS ET DES STYLOS. UNE RAINURE À L'ARRIÈRE ACCÉPTE LES CARTES D'AFFAIRE. LE MONTAGE SE FAIT À L'AIDE DE DEUX VIS #6 x 3/4" TÊTE PLATE (VIS NON INCLUSES)

THE 636N-KO HOLDS FIVE 3.5" DISKETTES, A SELF-STICK NOTE PAD, PAPER CLIPS, PENS AND PENCILS. EASY MOUNTING WITH TWO #6 x 3/4" FLAT HEAD SCREWS (SCREWS NOT INCLUDED)

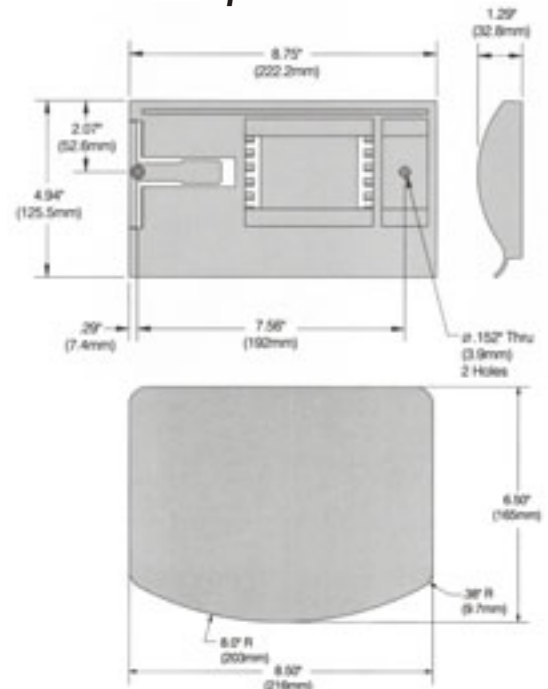
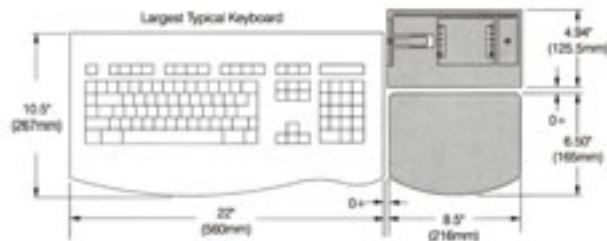

#	# QUINKO-TEK	# SPECTRUM	DESCRIPTION	DIMENSION		COULEUR COLOR	CAPACITÉ / CAPACITY						CAISSE CASE
				longueur length	largeur width		DVD	CD	DOUBLE CD	VHS TAPE	AUDIO TAPE	3 1/2" DISKETTE	
1	636N - KO	440B	organisateur / organizer	125.5mm	192mm	NOIR / BLACK	-	-	-	-	-	5	100
2	631N - PS	490B	tapis à souris / mouse pad	165mm	216mm	NOIR / BLACK	-	-	-	-	-	-	100

Spectrum 451

Organisateur de bureau rangeable II Radius organizer II

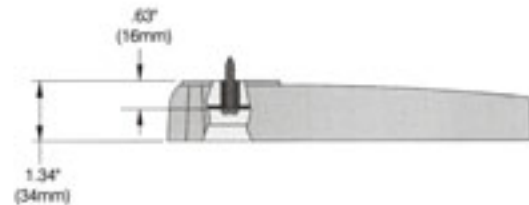
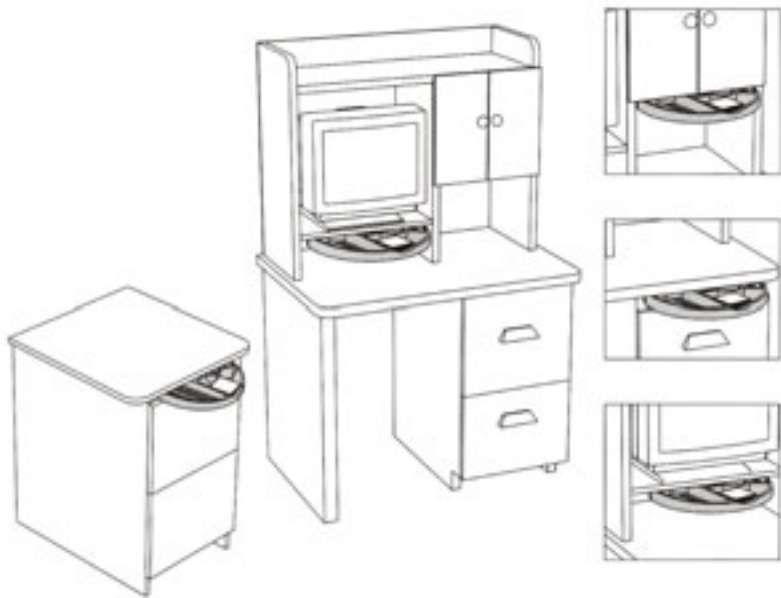
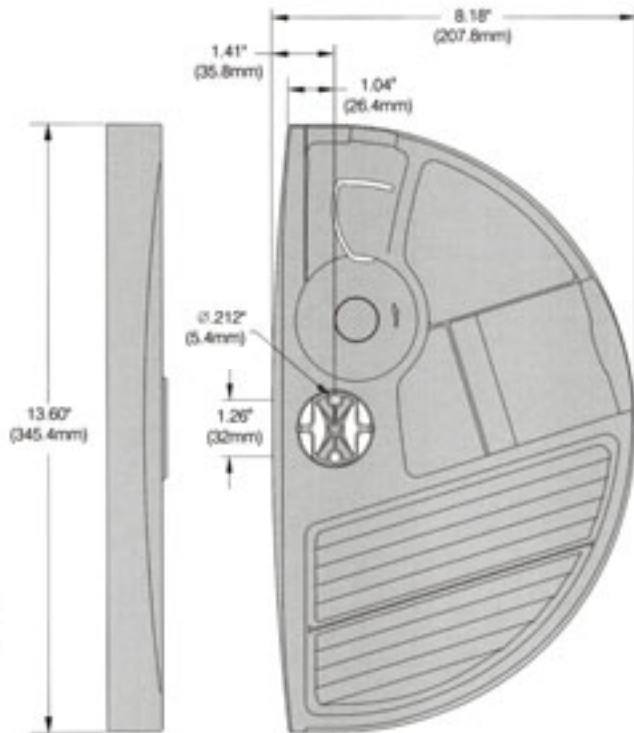
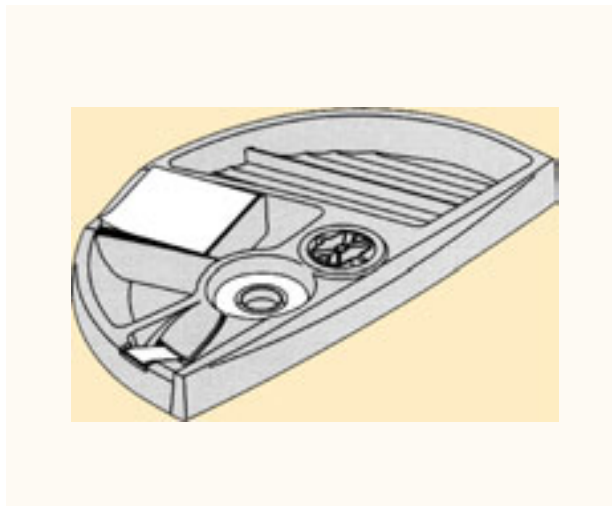

* S.V.P. NOTER : A CAUSE D'ENTENTES ENTRE SPECTRUM ET CERTAINS ASSOCIÉS, CE PRODUIT NE PEUT ÊTRE VENDU À L'INDUSTRIE " PRÊT À ASSEMBLER " .

* PLEASE NOTE ; BECAUSE OF AGREEMENTS BETWEEN SPECTRUM AND CERTAIN ASSOCIATES, THIS PRODUCT CANNOT BE SOLD TO THE " RTA " INDUSTRY.

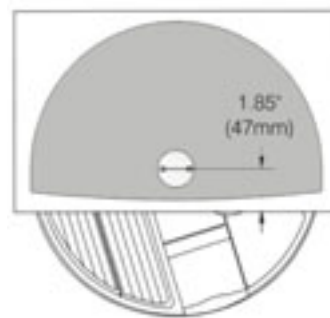
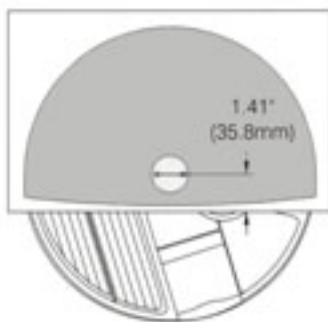
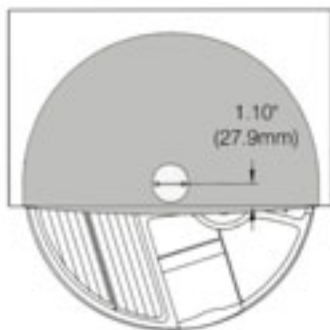

#	# QUINKO-TEK	# SPECTRUM	DESCRIPTION	DIMENSION		COULEUR COLOR	CAPACITÉ / CAPACITY					CAISSE CASE
				hauteur height	largeur width		DVD	CD	DOUBLE CD	VHS TAPE	AUDIO TAPE	
1	630N - RO	451	organisateur / organizer	34mm	345.4mm	NOIR / BLACK	-	-	-	-	-	30

Spectrum 455

Mini organisateur de bureau rangeable Mini radius organizer

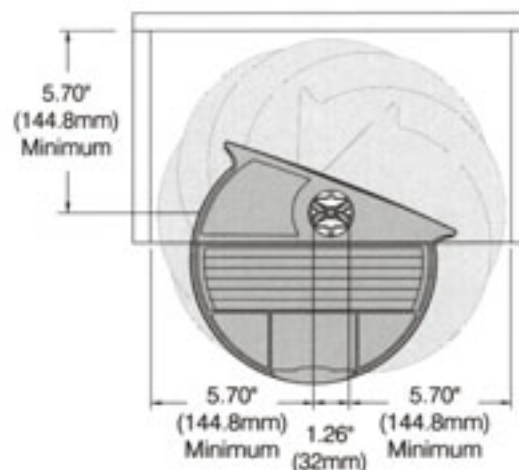
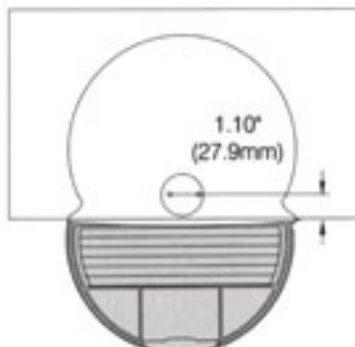
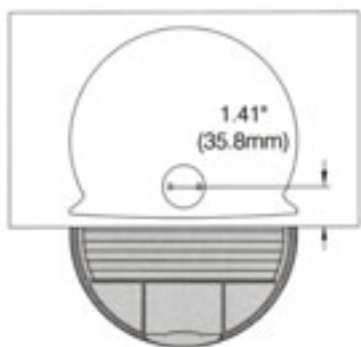
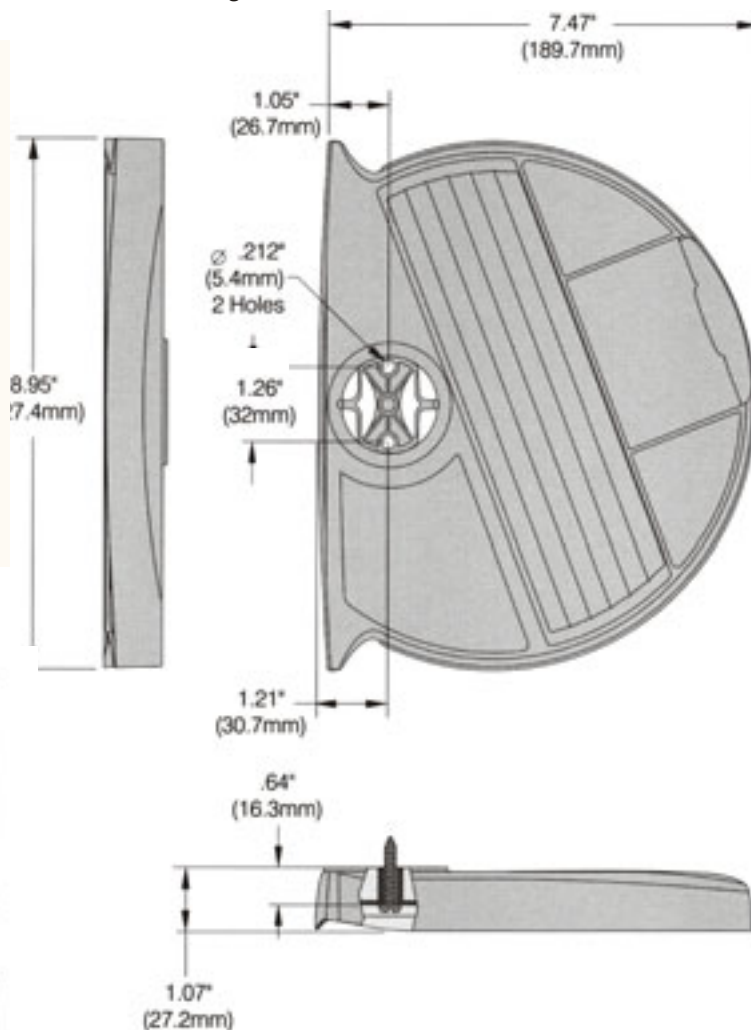
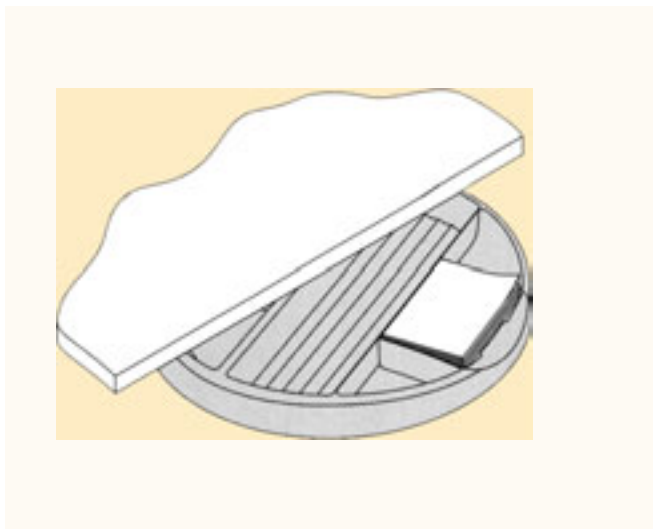

* DISPONIBLE POUR TOUS LES SECTEURS DE L'INDUSTRIE DE MEUBLES ET ARMOIRES.

* AVAILABLE TO ALL SECTORS OF THE FURNITURES AND CABINET INDUSTRY.

#	# QUINKO-TEK	# SPECTRUM	DESCRIPTION	DIMENSION		COULEUR COLOR	CAPACITÉ / CAPACITY					CAISSE CASE	
				hauteur height	largeur width		DVD	CD	DOUBLE CD	VHS TAPE	AUDIO TAPE		3 1/2" DISKETTE
1	621N - RJ	455	mini organisateur / mini organizer	27.2mm	227.4mm	NOIR / BLACK	-	-	-	-	-	-	40

AUTRES COULEURS DISPONIBLES SUR COMMANDE SPÉCIALE
OTHER COLORS ARE AVAILABLE ON SPECIAL ORDER

Spectrum 460 - 465

Système de rangement SHELFMAX SHELFMAX storage system

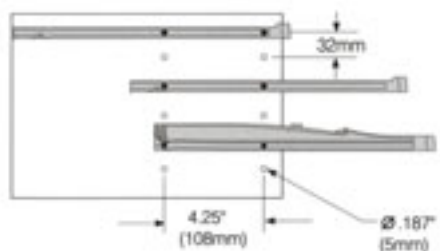
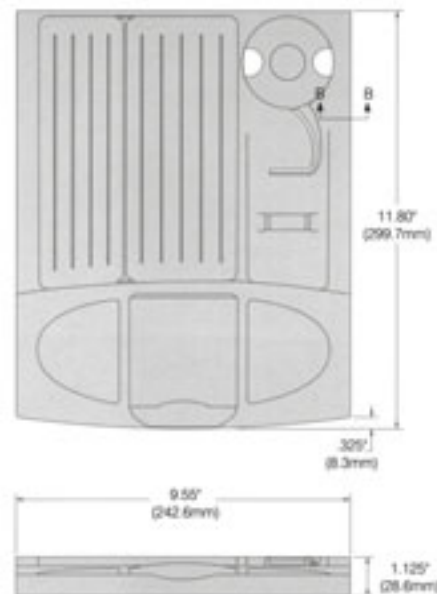
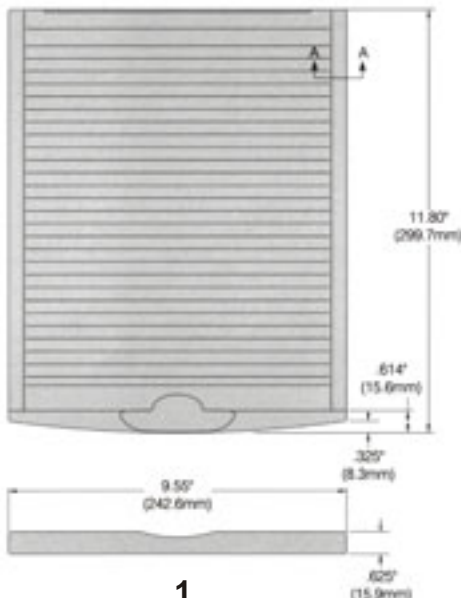
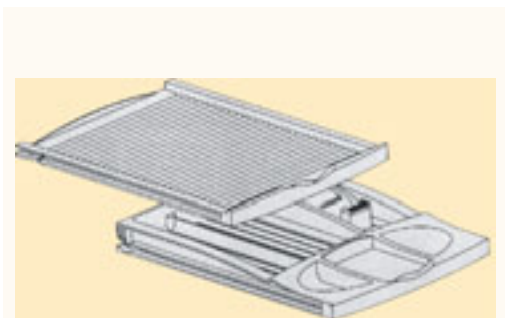

1

2

#	# QUINKO-TEK	# SPECTRUM	DESCRIPTION	DIMENSION		COULEUR COLOR	CAPACITÉ / CAPACITY						CAISSE CASE
				longueur length	largeur width		DVD	CD	DOUBLE CD	VHS TAPE	AUDIO TAPE	3 1/2" DISKETTE	
1	625N - PS	460	org. papier / paper org.	299.7mm	242.6mm	NOIR / BLACK	-	-	-	-	-	-	50
2	625N - OG	465	organisateur / organizer	299.7mm	242.6mm	NOIR / BLACK	-	-	-	-	-	-	20

Spectrum 510

Support CD CD rack

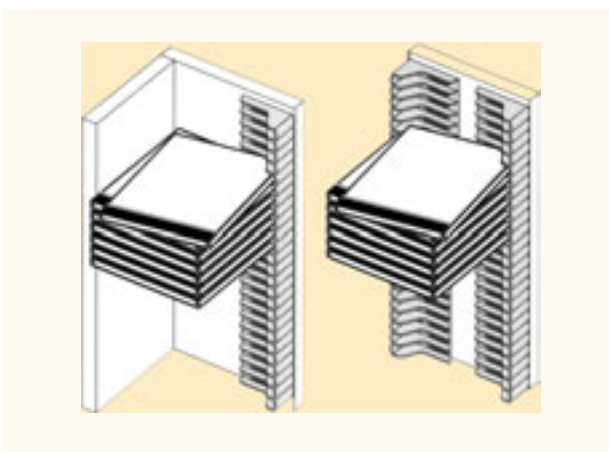

LE 635N - CD PEUT ÊTRE POSÉ HORIZONTELEMENT OU VERTICALEMENT DÉPENDANT DE L'APPLICATION DÉSIRÉE . VOUS AVEZ SIMPLEMENT A POUSSER LE DISQUE COMPACT VERS LE CÔTÉ OUVERT ET LE DISQUE SE PRESENTERA DANS VOTRE MAIN DANS UNE MOTION FLUIDE. VOUS POUVEZ POSER UN SEUL MORCEAU OU POSER UNE PAIRE POUR DES APPLICATIONS OÙ UNE FORCE MAXIMUM EST NECESSAIRE.

THE 635N - CD CAN BE USED HORIZONTALLY OR VERTICALLY DEPENDING ON THE DESIRED APPLICATION. A SIMPLE PUSH OF A FINGER IS ALL THAT IS NEEDED AND THE CD WILL ROTATE AND PRESENT ITSELF IN YOUR HAND IN ONE FLUID MOTION. USE TWO PIECES FOR MAXIMUM STRENGTH APPLICATIONS.

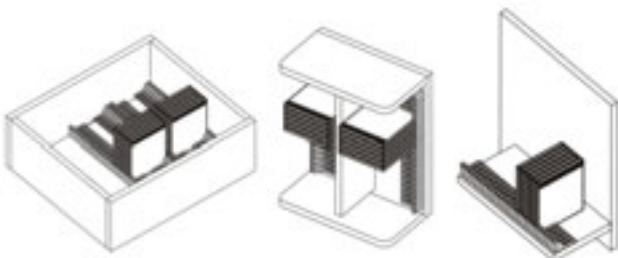
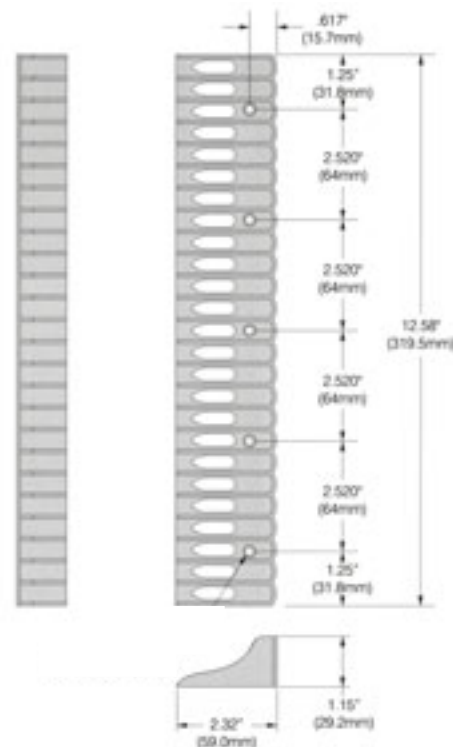

#	# QUINKO-TEK	# SPECTRUM	DESCRIPTION	DIMENSION		COULEUR COLOR	CAPACITÉ / CAPACITY						CAISSE CASE
				longueur length	largeur width		DVD	CD	DOUBLE CD	VHS TAPE	AUDIO TAPE	3 1/2" DISKETTE	
1	635N - CD	510	support CD / CD rack	319.5mm	59mm	NOIR / BLACK	-	25	-	-	-	-	100

Spectrum 540 - 541

Support CD JEWEL TRAC JEWEL TRAC CD rack

**L'UNIQUE ET ORIGINAL !
THE ONE AND ONLY**

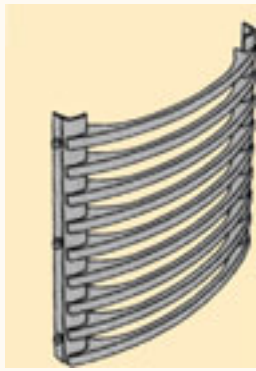

* PROTÉGÉ PAR BREVET / PATENT PROTECTED

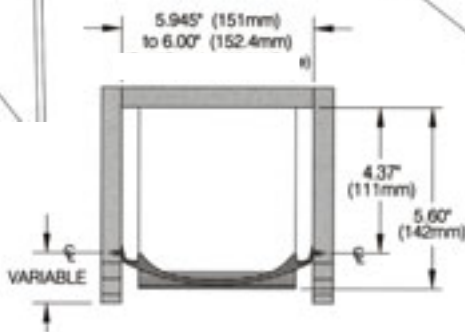
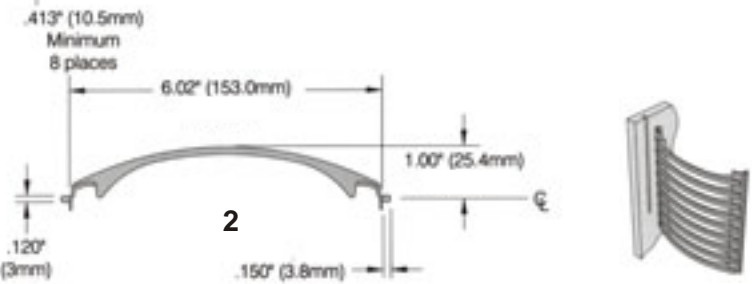
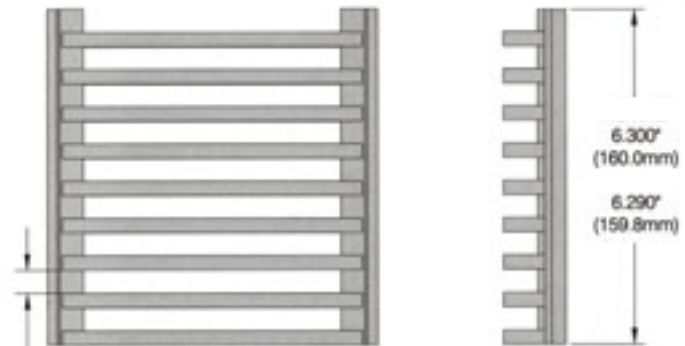
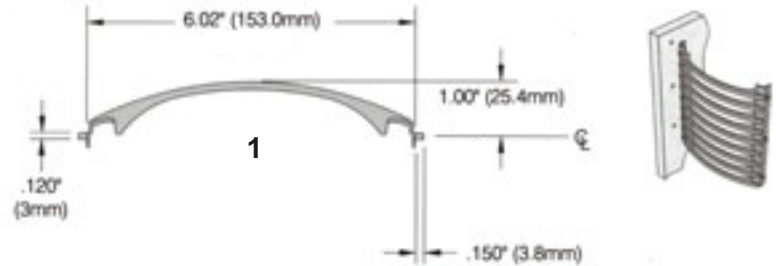
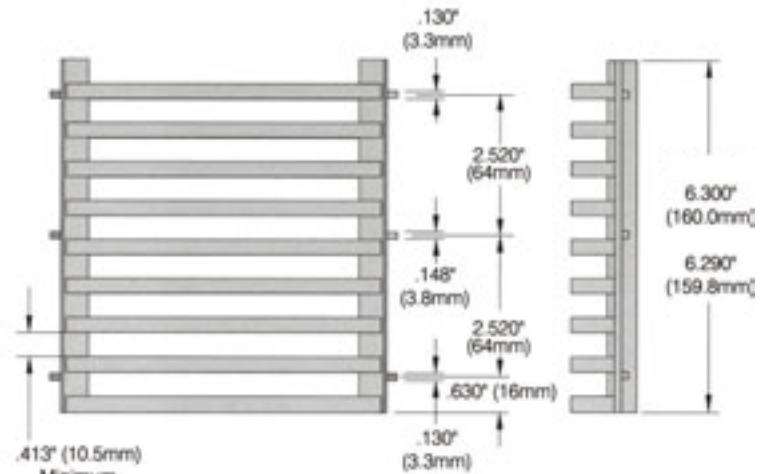
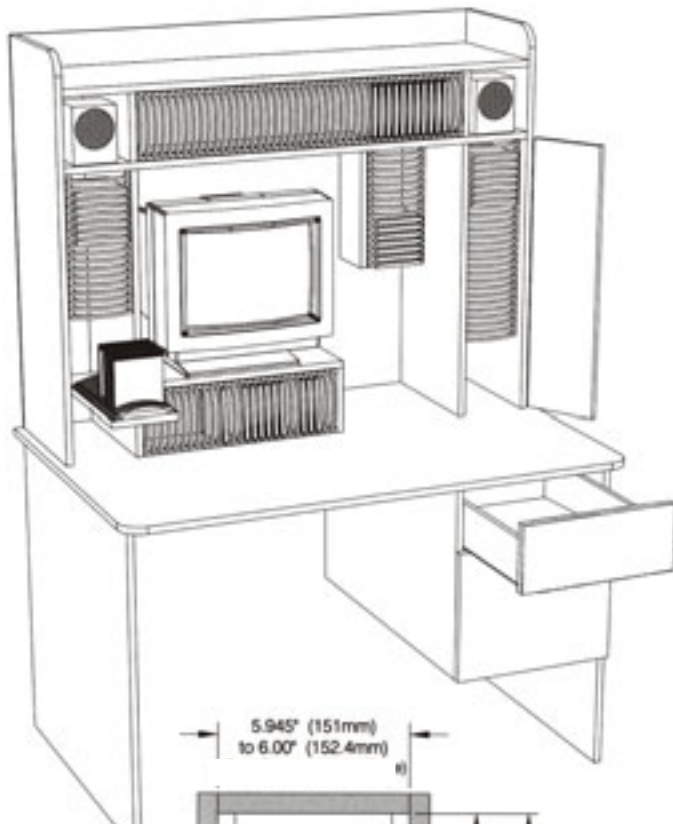

#	# QUINKO-TEK	# SPECTRUM	DESCRIPTION	DIMENSION		COULEUR COLOR	CAPACITÉ / CAPACITY					CAISSE CASE
				hauteur height	largeur width		DVD	CD	DOUBLE CD	VHS TAPE	AUDIO TAPE	
1	629N - CD	540	support CD / CD rack	159.8mm	153mm	NOIR / BLACK	-	9	-	-	-	300
1	629AG - CD	540S - 13	support CD / CD rack	159.8mm	153mm	ARGENT / SILVER	-	9	-	-	-	300
1	629P - CD	540S - 02	support CD / CD rack	159.8mm	153mm	GREIGE	-	9	-	-	-	300
1	629C - CD	540S - 07	support CD / CD rack	159.8mm	153mm	NICKEL	-	9	-	-	-	300
1	629G - CD	540S - 01	support CD / CD rack	159.8mm	153mm	GRAPHITE	-	9	-	-	-	300
2	629R - CD	541	support CD / CD rack	159.8mm	153mm	NOIR / BLACK	-	9	-	-	-	300

AUTRES COULEURS DISPONIBLES SUR COMMANDE SPÉCIALE / OTHER COLORS ARE AVAILABLE ON SPECIAL ORDER

Spectrum 544

Support DVD JEWEL TRAC
JEWEL TRAC DVD rack

L'UNIQUE ET ORIGINAL !
THE ONE AND ONLY

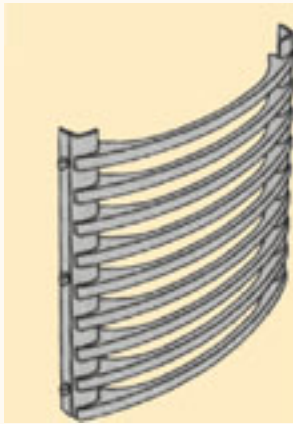

* PROTÉGÉ PAR BREVET / PATENT PROTECTED

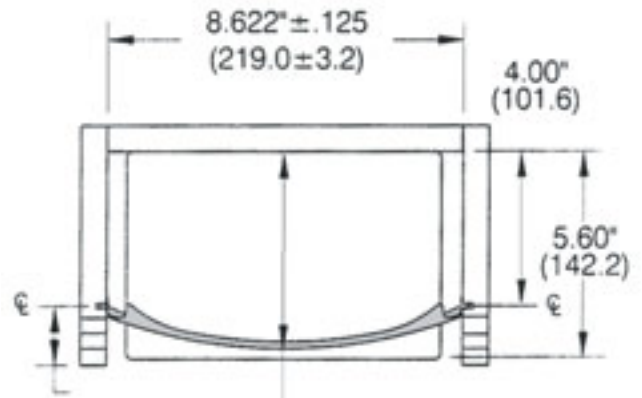
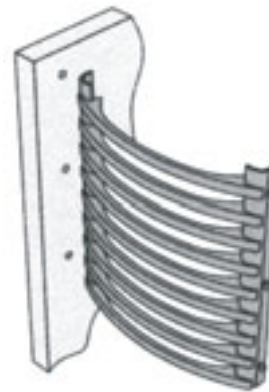
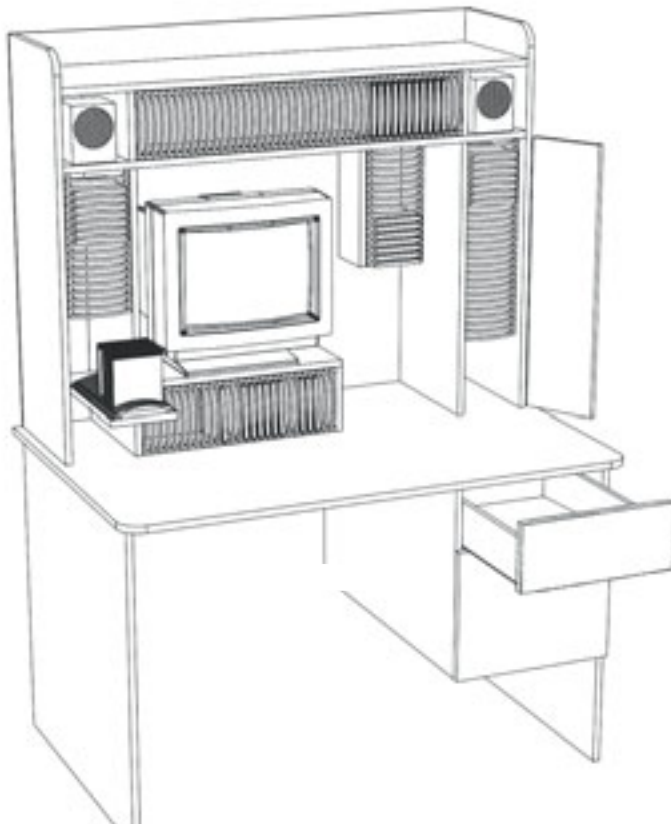
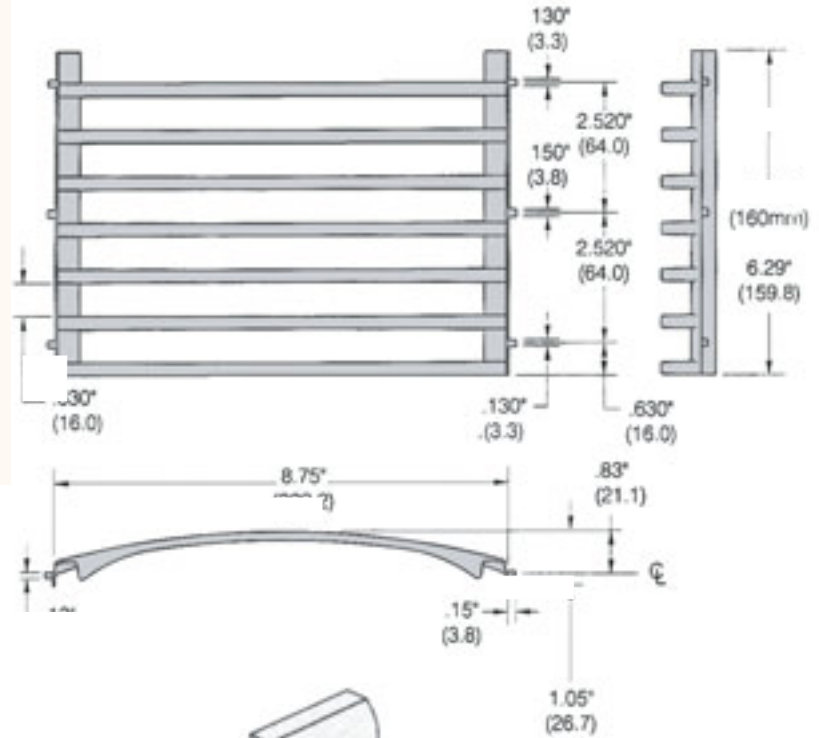

#	# QUINKO-TEK	# SPECTRUM	DESCRIPTION	DIMENSION		COULEUR COLOR	CAPACITÉ / CAPACITY					CAISSE CASE
				hauteur height	largeur width		DVD	CD	DOUBLE CD	VHS TAPE	AUDIO TAPE	
1	629N - DVD	544	support DVD / DVD rack	159.8mm	222.2mm	NOIR / BLACK	7	-	-	-	-	340

AUTRES COULEURS DISPONIBLES SUR COMMANDE SPÉCIALE / OTHER COLORS ARE AVAILABLE ON SPECIAL ORDER

Spectrum 554

Support CD/DVD Jewel trac Jewel Trac CD/DVD rack

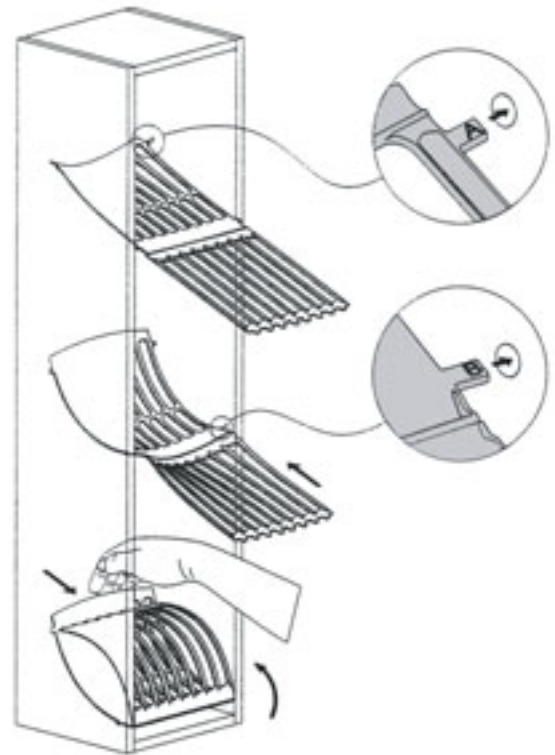
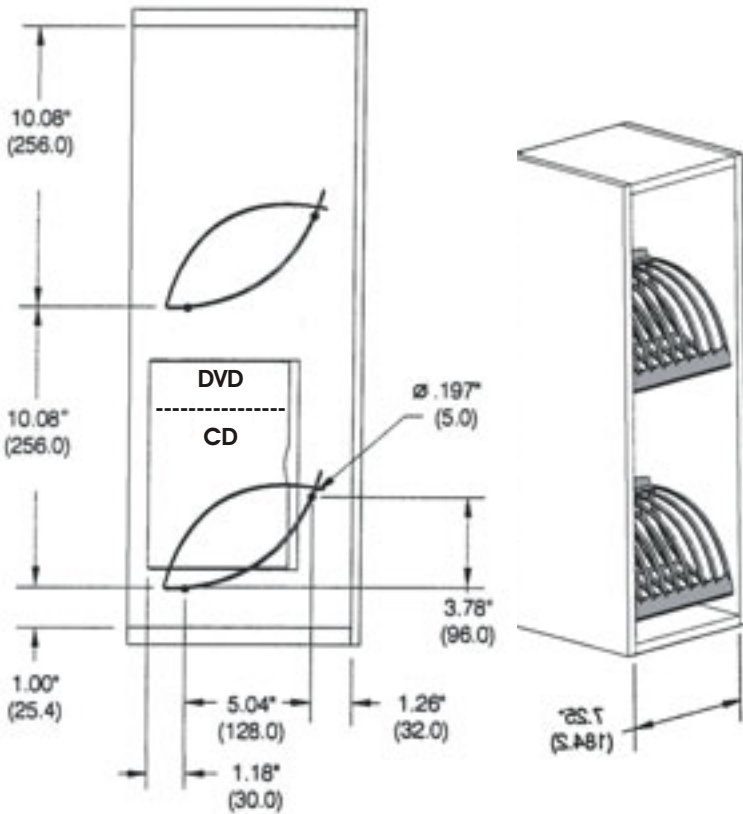
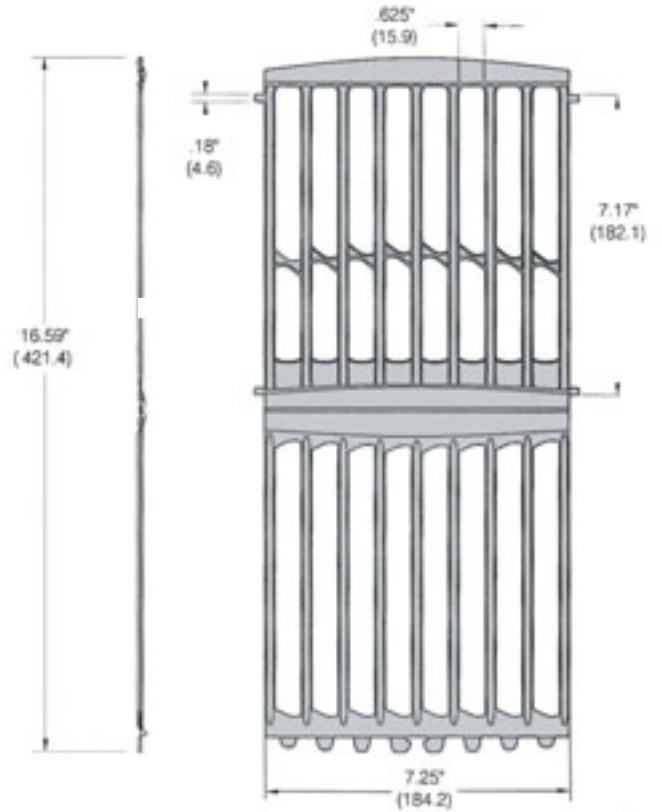
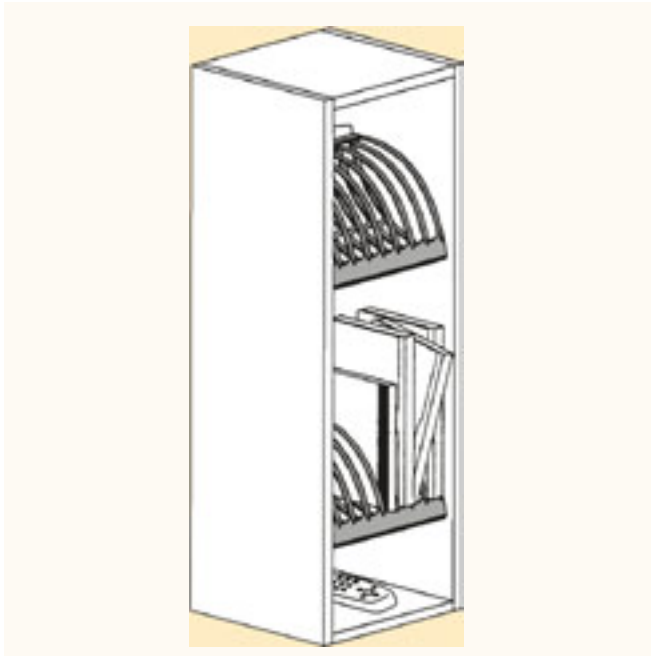

#	# QUINKO-TEK	# SPECTRUM	DESCRIPTION	DIMENSION		COULEUR COLOR	CAPACITÉ / CAPACITY					CAISSE CASE	
				hauteur height	largeur width		DVD	CD	CD - R	VHS TAPE	AUDIO TAPE		3 1/2" DISKETTE
1	623N - JT	554	supp CD-DVD / CD-DVD Rack	421.4mm	184.2mm	NOIR / BLACK	8	8	16	-	-	-	200

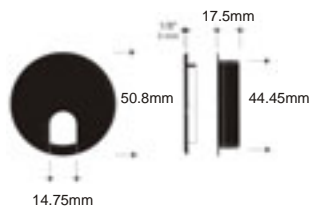
Qline
**PASSE-FILS PLASTIQUE
 PLASTIC GROMMETS**

# QUINKO-TEK	COULEUR COLOR	CAISSE CASE
0623 -BL	BLANC / WHITE	250
0623 -BR	BRUN / BROWN	250
0623 -NR	NOIR / BLACK	250

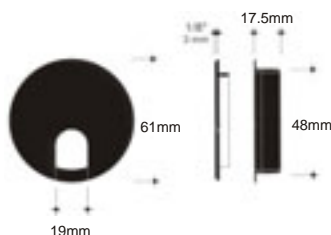
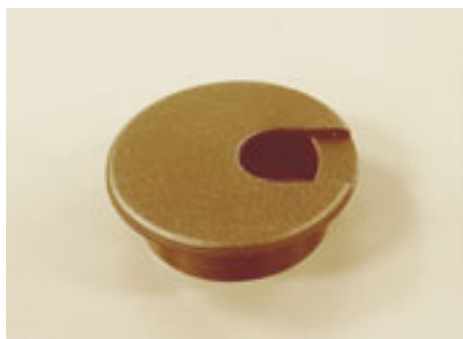
 PASSE-FILS PLASTIQUE
 PLASTIC GROMMETS

0622 - BL	BLANC / WHITE	250
0622 - NR	NOIR / BLACK	250

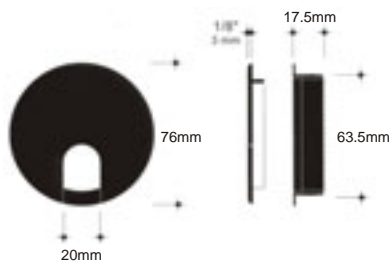
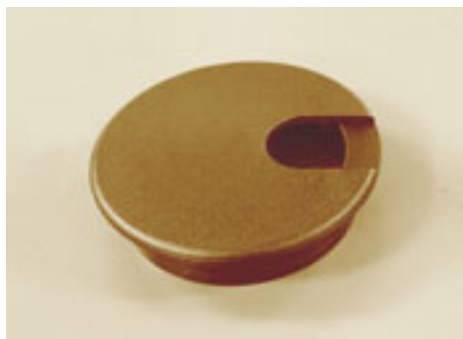
 PASSE-FILS PLASTIQUE
 PLASTIC GROMMETS

0624 -BL	BLANC / WHITE	250
0624 -NR	NOIR / BLACK	250

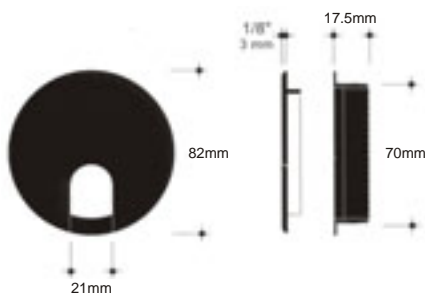
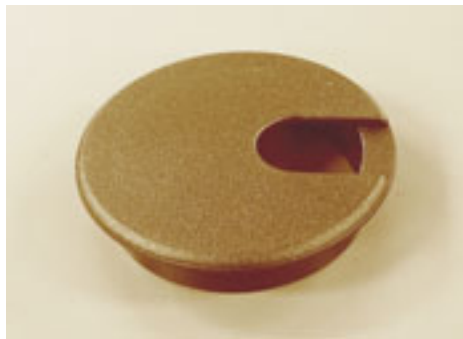
 PASSE-FILS PLASTIQUE
 PLASTIC GROMMETS

624N - 03	NOIR / BLACK	250
-----------	--------------	-----

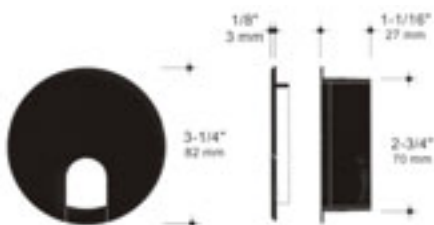
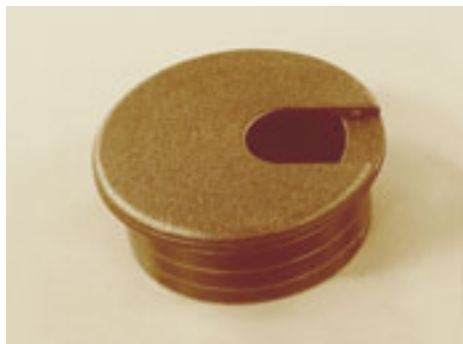
 PASSE-FILS PLASTIQUE
 PLASTIC GROMMETS

624N - 25	NOIR / BLACK	250
-----------	--------------	-----

 PASSE-FILS PLASTIQUE
 PLASTIC GROMMET



PASSE-FILS ET AUGET À CRAYONS
GROMMETS AND PENCIL TRAY

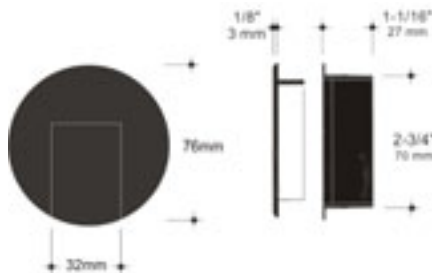

# QUINKO-TEK	COULEUR COLOR	CARTON CARTON
620N - 03	NOIR / BLACK	250

PASSE-FILS PLASTIQUE
PLASTIC GROMMET

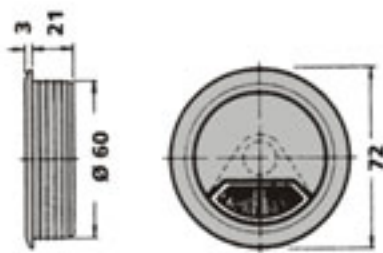

627N - 60	NOIR / BLACK	250
-----------	--------------	-----

PASSE-FILS PLASTIQUE
PLASTIC GROMMET

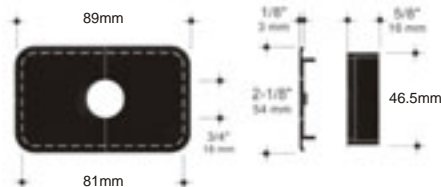
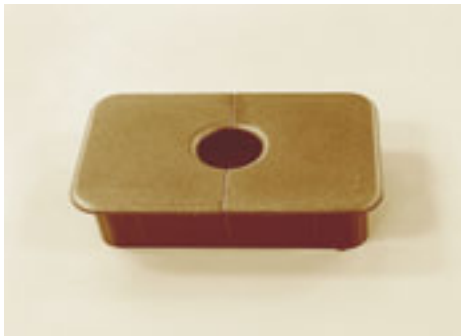

633N - 16	NOIR / BLACK	250
-----------	--------------	-----

PASSE-FILS PLASTIQUE
PLASTIC GROMMET

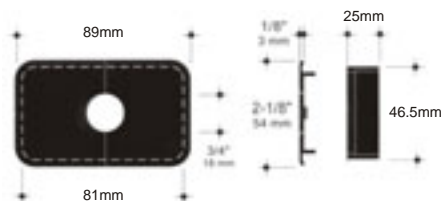

633N - 25	NOIR / BLACK	250
-----------	--------------	-----

PASSE-FILS PLASTIQUE
PLASTIC GROMMET

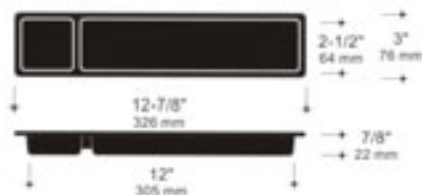
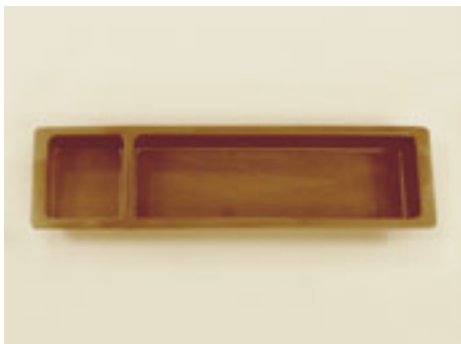

0151 - NR	NOIR / BLACK	50
-----------	--------------	----

AUGET À CRAYONS
PENCIL TRAY



**AUGET À CRAYONS
PENCIL TRAY**



# QUINKO-TEK	COULEUR COLOR	CARTON CARTON
151N - 13 1/4	NOIR / BLACK	50

AUGET À CRAYONS
PENCIL TRAY

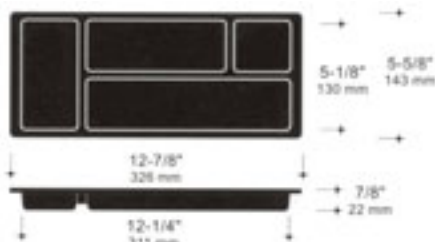
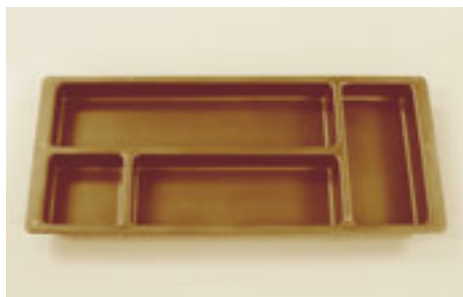

0152 - NR	NOIR / BLACK	50
-----------	--------------	----

AUGET À CRAYONS
PENCIL TRAY

**PASSE-FILS, PASSE PAPIER ET AUGET À CRAYONS
PLASTIC GROMMET, PAPER GUIDE AND PENCIL TRAY**

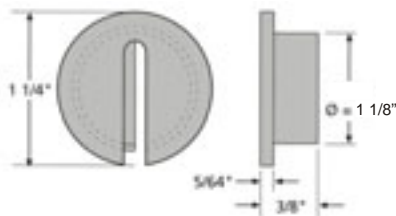

0612 - BL	BLANC / WHITE	1,000
0612 - BR	BRUN / BROWN	1,000
0612 - NR	NOIR / BLACK	1,000

PASSE-FILS PLASTIQUE
PLASTIC GROMMETS

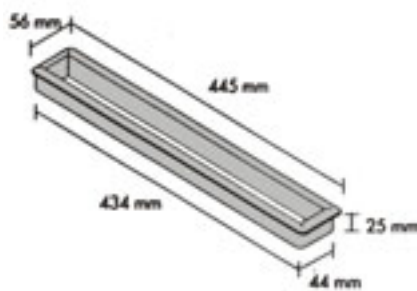

0620 - BL	BLANC / WHITE	50
0620 - NR	NOIR / BLACK	50

PASSE PAPIER
PAPER GUIDE

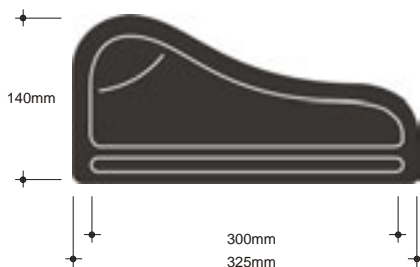

150N - 13	NOIR / BLACK	50
-----------	--------------	----

AUGET À CRAYONS
PENCIL TRAY

SUPPORTS À ÉCRANS PLAT / LCD MONITOR SUPPORTS



K986AG2C

K986AG4L

K986AG6L

Conception ergonomique et flexibilité extraordinaire, fabriqué dans un alliage d'aluminium de haute qualité ; modulaire ; utilisation maximale de l'espace
Extraordinary Design and Flexibility, High Quality Aluminum, Ergonomic, Optimum Space Utilization, Modular.

	# QUINKO-TEK	DESCRIPTION	UNITÉ UNIT		# QUINKO-TEK	DESCRIPTION	UNITÉ UNIT
	986AG - AD	JOINT UNIVERSEL / UNIVERSAL JOINT	1		987ADC - SR	400 MM	1
	986AD - 65	BLOC DE CONNEXION / CONNECTION BLOCK	1		987ADL - SR	700 MM	1
	986AG - 180	BRAS COURT / SHORT ARM	1		987ADC - PF	400 MM	1
	986AG - 250	BRAS LONG / LONG ARM	1		987ADL - PF	700 MM	1
	986AG - MR	JOINT POUR MONTAGE MURAL / WALL MOUNT JOINT	1		BRIDE DE SERRAGE / CLAMP MOUNT		
					987ADC - PF	400 MM	1
					987ADL - PF	700 MM	1
					BRIDE DE PASSE-FILS / GROMMET MOUNT		
					BLOC À DOUBLE CONNEXION / DOUBLE CONNECTION BLOCK		
					986AG - DB		1

SUPPORTS À MONITEURS LCD / LCD MONITOR SUPPORTS



# QUINKO-TEK	DESCRIPTION	UNITÉ UNIT
985GR3 - MS	SUPPORT MULTI LCD À POTEAUX, LARGEUR VARIABLE / MULTI LCD SYSTEM, VARIABLE WIDTH	1

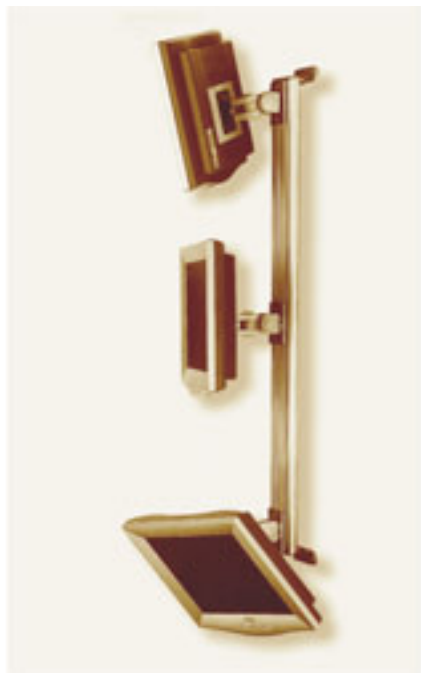

985GR - ML	SUPPORT MURAL GLISSANT À ÉCRAN LCD / WALL MOUNT LCD MONITOR TRACK SYSTEM	1
------------	--	---

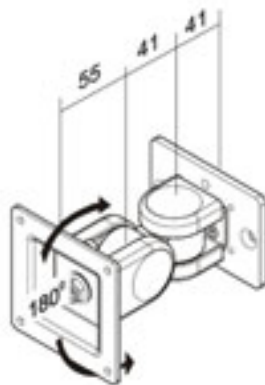

985AD - VS	SYSTÈME DE MONTAGE PIVOTANT POUR 985GR3 - MS ET 985GR - ML / SWIVEL MOUNT BRACKET, TO BE USED WITH 985GR3 - MS AND 985GR - ML	1
------------	---	---

SUPPORTS À MONITEURS LCD / LCD MONITOR SUPPORTS



Largeur fixe / Fixed width

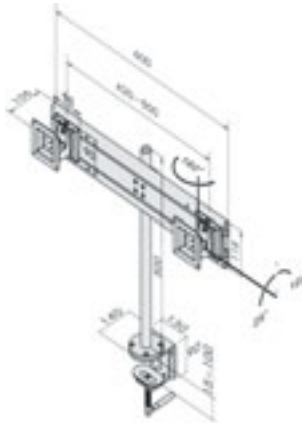

# QUINKO-TEK	DESCRIPTION	UNITÉ UNIT
984NR2 - MS	SYSTÈME MULTI LCD À POTEAUX, LARGEUR FIXE / POST MULTI LCD SYSTEM, FIXED WIDTH	1



Support à Moniteur CRT /
CRT Monitor Holder

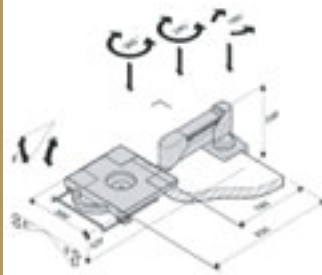

0982 - MS	SUPPORT À MONITEUR CATHODIQUE / CRT MONITOR SUPPORT	1
-----------	---	---



Poste de travail ajustable /
Adjustable Work Station



EZLIFT - 23	MÉCANISME AJUSTABLE POUR POSTE DE TRAVAIL / LOW-PROFILE ADJUSTABLE WORKSTATION MECHANISM	1
-------------	--	---



Système à rail pour plusieurs écrans ou moniteurs ACL / *Multiple LCD TV or Monitor Track System*



Bras pour écrans ou moniteurs ACL / *Hospital LCD TV or Monitor Arm*



Système à rail multi-directionnel pour plusieurs écrans ou moniteurs ACL / *Multi-directional LCD TV or Monitor Track System*

**EXEMPLES
D'APPLICATIONS
APPLICATIONS
EXAMPLES**



Montage mural pour téléviseur à plasma / *Plasma TV Wallmount*



Station mobile de travail / *Mobile Workstation Cart*

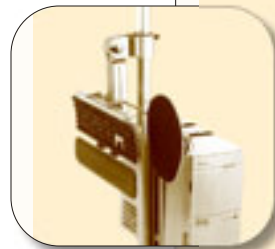
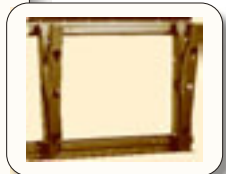

Ergo Stream

MÉCANISMES POUR SUPPORTS À CLAVIERS KEYBOARD SUPPORT MECHANISMS



# QUINKO-TEK	DESCRIPTION	UNITÉ UNIT
TSS-18-K	18" EXTENSION	1
TSS-23-K	23" EXTENSION NOIR / BLACK	1

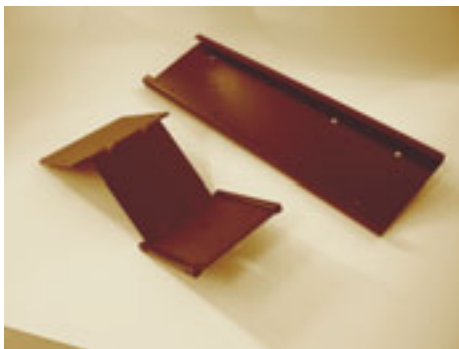

EPZ-18-S0	BRAS GLISSANT ERGONOMIQUE SIMPLE POUR CLAVIER / BASIC ERGONOMIC SLIDING KEYBOARD ARM	1
-----------	---	---

SUPPORTS À CLAVIER / KEYBOARD SUPPORTS



# QUINKO-TEK	DESCRIPTION	UNITÉ UNIT
A1400-01/02/03	SUPPORT À CLAVIER / KEYBOARD TRAY	1
A1402-01/02/03	SUPPORT À CLAVIER ET À SOURIS / KEYBOARD AND MOUSE TRAY	1
A1403-01/02/03	SUPPORT À CLAVIER, REPOSE-POIGNET ET SUPPORT À SOURIS / KEYBOARD TRAY, WRIST REST AND MOUSE TRAY	1

01 - NOIR / BLACK

02 - MASTIC / PUTTY

03 - CHARBON / CHARCOAL

SUPPORTS À CPU / CPU HOLDERS

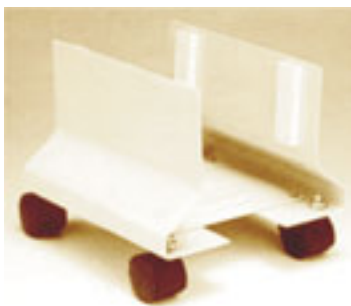
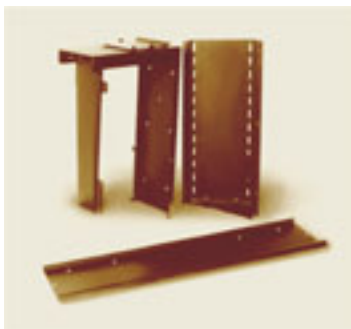
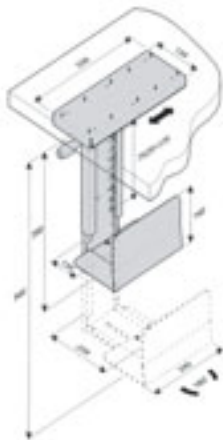

# QUINKO-TEK	DESCRIPTION	UNITÉ UNIT
981N-CPU	AJUSTEMENT MULTIPLE : HAUTEUR, LARGEUR, ROTATION ET GLISSAGE MULTI-ADJUSTMENT : HEIGHT, WIDTH, SWIVEL AND SLIDE OUT	1
981NSS-CPU	ROTATION ET GLISSAGE VERTICAUX / VERTICAL SWIVEL AND SLIDE	1
981NFX-CPU	MONTAGE FIXE VERTICAL FIXED VERTICAL MOUNTING	1
981NHR-CPU	MONTAGE FIXE HORIZONTAL / FIXED HORIZONTAL MOUNTING	1
981BMB-CPU	MINI-MOBILE SUR 4 ROUES / MINI-MOBILE ON 4 CASTERS	1

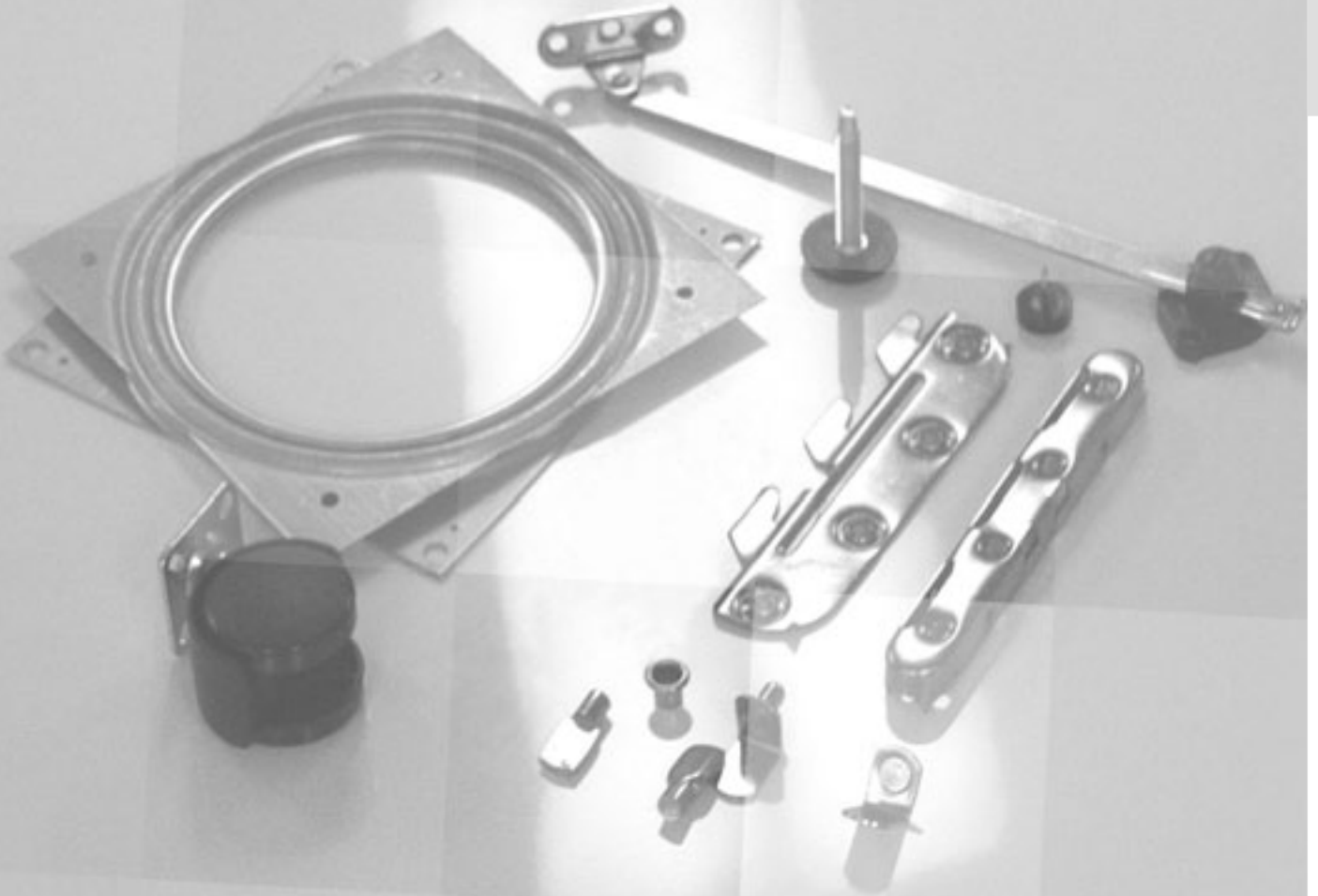

SUPPORTS À TABLETTE / SHELF SUPPORTS

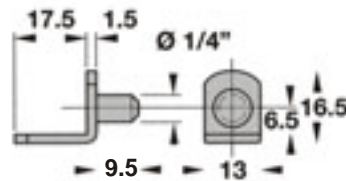

# QUINKO-TEK	FINI FINISH	MATERIEL MATERIAL	CAISSE CASE
0100 - NC	NICKEL	METAL	2,500
0100 - LT	LAITON / BRASS	METAL	2,500

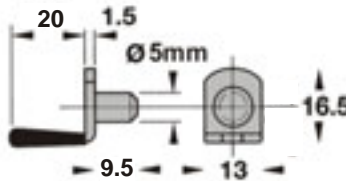

# QUINKO-TEK	FINI FINISH	MATERIEL MATERIAL	CAISSE CASE
100V - LT	LAITON / BRASS BRUN / BROWN	METAL PLASTIQUE PLASTIC	2,500

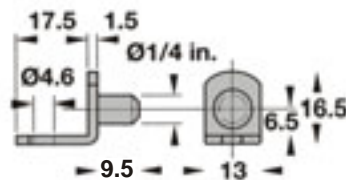

# QUINKO-TEK	FINI FINISH	MATERIEL MATERIAL	CAISSE CASE
100T - LT	LAITON / BRASS	METAL	2,500



# QUINKO-TEK	FINI FINISH	A	MATERIEL MATERIAL	CAISSE CASE
0101 - CH	NICKEL	7mm	METAL	5,000
0101 - LT	LAITON / BRASS	7mm	METAL	5,000
101N - 05	NICKEL	5mm	METAL	5,000
101L - 05	LAITON / BRASS	5mm	METAL	5,000
101C - 04	NICKEL	4mm	METAL	5,000

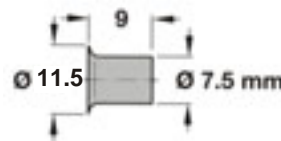

# QUINKO-TEK	FINI FINISH	MATERIEL MATERIAL	CAISSE CASE
0102 - CH	NICKEL	METAL	5,000
0102 - LT	LAITON / BRASS	METAL	5,000

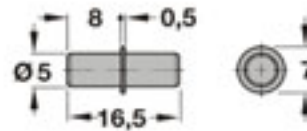

# QUINKO-TEK	FINI FINISH	MATERIEL MATERIAL	CAISSE CASE
108Z - 05	ZINC	METAL	5,000

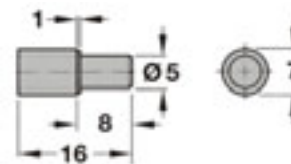

# QUINKO-TEK	FINI FINISH	MATERIEL MATERIAL	CAISSE CASE
108Z - CL	ZINC CLAIR / CLEAR	METAL PLASTIQUE PLASTIC	5,000



# QUINKO-TEK	FINI FINISH	A	MATERIEL MATERIAL	CAISSE CASE
6129 - 10	ZINC	10"	METAL	250
6129 - 7 3/4	ZINC	7 3/4"	METAL	250

SUPPORTS À TABLETTE / SHELF SUPPORTS

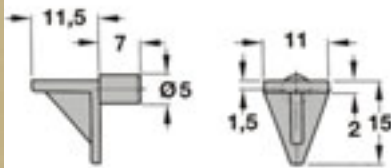

# QUINKO-TEK	FINI FINISH	MATERIEL MATERIAL	CAISSE CASE
0111 - BL	BLANC / WHITE	PLAST.	10,000
0111 - BR	BRUN / BROWN	PLAST.	10,000
0111 - NR	NOIR / BLACK	PLAST.	10,000
0111 - CL	CLAIR / CLEAR	PLAST.	10,000

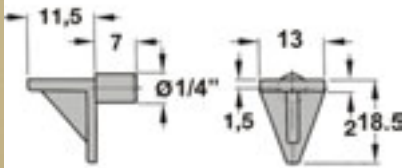

0107 -BL	BLANC / WHITE	PLAST.	10,000
0107 - BR	BRUN / BROWN	PLAST.	10,000
0107 - NR	NOIR / BLACK	PLAST.	10,000
0107 - CL	CLAIR / CLEAR	PLAST.	10,000

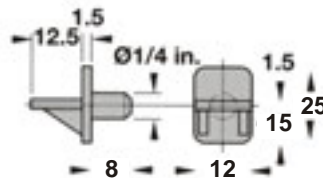

107F - BL	BLANC / WHITE	PLAST.	10,000
107F - CL	CLAIR / CLEAR	PLAST.	10,000

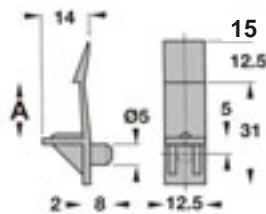

# QUINKO-TEK	FINI FINISH	A	MATERIEL MATERIAL	CAISSE CASE
0112 - NR	NOIR / BLACK	13mm	PLAST.	10,000
0113 - BL	BLANC / WHITE	16mm	PLAST.	10,000
0113 - NR	NOIR / BLACK	16mm	PLAST.	10,000



0108 - BR	BRUN / BROWN	PLAST.	10,000
-----------	--------------	--------	--------

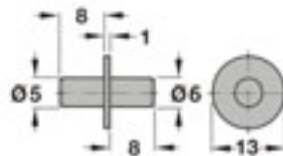

0106 - BL	BLANC / WHITE	PLAST.	10,000
-----------	---------------	--------	--------

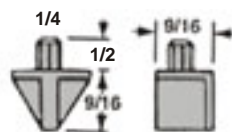





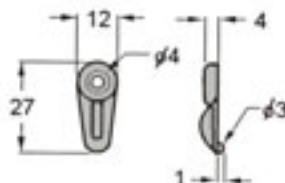



0104 - CL	CLAIR / CLEAR	PLAST.	10,000
-----------	---------------	--------	--------

SUPPORTS DE VITRE / MIROIR GLASS / MIRROR RETAINER

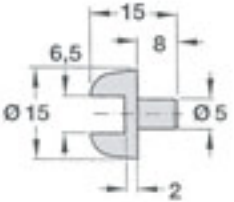

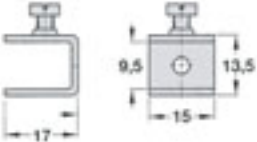
0115 - CL	CLAIR / CLEAR	PLAST.	10,000
0115 - BR	BRUN / BROWN	PLAST.	10,000

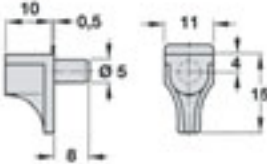
SUPPORTS A TABLETTE / SHELF SUPPORTS

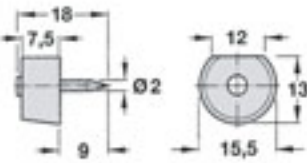
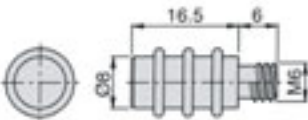
	# QUINKO-TEK	GROSSEUR SIZE	COULEUR COLOR	MATÉRIAL MATERIAL	CAISSE CASE	
		0108 - CH	5x24mm	CHROME	ACIER / STEEL	100
		105P - CL	5mm	CLAIR / CLEAR	PLAST. / PLAST.	1.000
		105N - 20	-	NOIR / BLACK	ACIER / STEEL	100
		109Z - CL	5mm	CLAIR / CLEAR	PLAST. & MÉTAL / PLAST. & METAL	100
		0105 - BL	-	BLANC WHITE	PLAST. / PLAST.	100
		0109 - NC 109I - NC	16.5mm 8mm	NICKEL NICKEL INSERT	ACIER / STEEL	1.000 1.000

ROULETTES POUR MEUBLES / FURNITURE CASTERS

# QUINKO-TEK	DIAM.	HAUTEUR HEIGHT	DIST. TROU DE VIS HOLE DIST	MAT.	COULEUR COLOR	CAPACITE CAPACITY	CAISSE CASE
	0190 - NR	40mm	55mm	32mm	PLAST.	NOIR - BLACK	25 KIL.
	0191 - NR	50mm	63mm	21mm	PLAST.	NOIR - BLACK	30 KIL.
	190F - NR	40mm	55mm	32mm	PLAST.	NOIR - BLACK	25 KIL.
	191F - NR	50mm	63mm	21mm	PLAST.	NOIR - BLACK	30 KIL.
	197N - VC	12mm	12mm	32mm	PLAST.	NOIR - BLACK	N/A
	B197 - NR - 6 X 197N - VC		DANS UN SAC AVEC VIS 1/2" IN A BAG WITH 1/2" SCREWS				
# QUINKO-TEK	DIAM.	HAUTEUR HEIGHT	DIAM. DE TIGE STEM DIAM.	MAT.	COULEUR COLOR	CAPACITE CAPACITY	CAISSE CASE
	0192 - NR	40mm	85mm	8mm	PLAST.	NOIR - BLACK	25 KIL.
	0193 - NR	50mm	97mm	8mm	PLAST.	NOIR - BLACK	30 KIL.
	192F - NR	40mm	85mm	8mm	PLAST.	NOIR - BLACK	25 KIL.
	193F - NR	50mm	97mm	8mm	PLAST.	NOIR - BLACK	30 KIL.
	193F - BR	50mm	97mm	8mm	PLAST.	BRUN - BROWN	30 KIL.
	193F - BL	50mm	97mm	8mm	PLAST.	BLANC - WHITE	30 KIL.
	193F - NSG	50mm	97mm	8mm	PLAST.	GRIS / GREY	30 KIL.

ROULETTES ET SOUS PATTES / CASTERS AND GLIDES



# QUINKO-TEK	DIAM.	HAUTEUR HEIGHT	DIST. TROU DE VIS HOLE DIST.	MAT.	COULEUR COLOR	CAPACITE CAPACITY	CAISSE CASE
0189 - NR	40mm	42mm	46mm	PLAST. METAL	NOIR / CHROME BLACK / CHROME	N/A	200

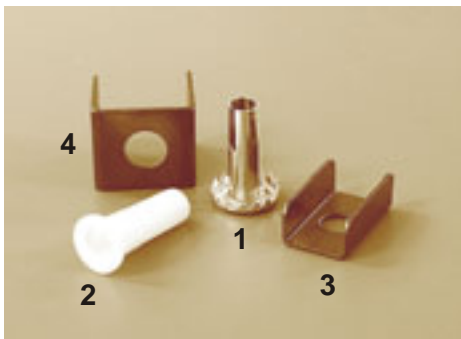

# QUINKO-TEK	DIAM.	HAUTEUR HEIGHT	DIAM. DE TROU INT. INT. DIAMETER	MAT.	COULEUR COLOR	CAPACITE CAPACITY	CAISSE CASE
1 0198 - ZC	9.5mm	33mm	8mm	METAL	CHROME	-	3,000
2 198P - BL	11mm	33mm	8mm	PLAST.	BLANC - WHITE	-	6,000
3 198U - NR	16.5mm	12.5mm	9.5mm	METAL	NOIR / BLACK	-	1,000
4 199U - NR	26mm largeur width	27mm	12mm	METAL	NOIR / BLACK	-	500



# QUINKO-TEK	DIAM.	HAUTEUR DU CLOU NAIL HEIGHT	EPAISSEUR THICKNESS	COULEUR COLOR	CAISSE CASE
131B - 5/8	16mm (5/8")	19mm (3/4")	6mm	BEIGE	10,000
131B - 3/4	19mm (3/4")	19mm (3/4")	6mm	BEIGE	10,000
131B - 1 1/8	28mm (1 1/8")	19mm (3/4")	6mm	BEIGE	10,000
131N - 5/8	16mm (5/8")	19mm (3/4")	6mm	NOIR / BLACK	10,000
131N - 1 1/8	28mm (1 1/8")	19mm (3/4")	6mm	NOIR / BLACK	10,000
131W - 5/8	16mm (5/8")	19mm (3/4")	6mm	BLANC / WHITE	10,000
131W - 3/4	19mm (3/4")	19mm (3/4")	6mm	BLANC / WHITE	10,000
141N - 5/8	16mm (5/8")	12mm (1/2")	6mm	NOIR / BLACK	10,000
141N - 3/4	19mm (3/4")	12mm (1/2")	6mm	NOIR / BLACK	10,000
141W - 5/8	16mm (5/8")	12mm (1/2")	6mm	BLANC / WHITE	10,000
142N - 1 1/8	28mm (1 1/8")	9.5mm (3/8")	6mm	NOIR / BLACK	10,000

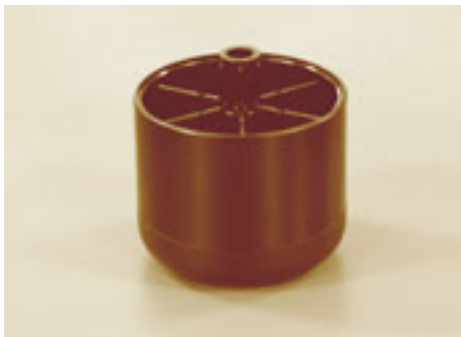

# QUINKO-TEK	DIAM.	DIAM. DE TIGE STEM DIAM.	EPAISSEUR THICKNESS	COULEUR COLOR	CAISSE CASE
0139 - NR	50mm	10mm	40mm	NOIR / BLACK	500



# QUINKO-TEK	DIAM.	DIAMETRE DE PIN PIN DIAMETER	EPAISSEUR THICKNESS	COULEUR COLOR	CAISSE CASE
132B - 3/4	19mm (3/4")	1/4-20 x 28mm	6mm	BEIGE	2,500
132N - 3/4	19mm (3/4")	1/4-20 x 28mm	6mm	NOIR / BLACK	2,500
132N - 1 1/8"	28mm (1 1/8")	5/16-18 x 44mm	6mm	NOIR / BLACK	1,000
134A - NR	25mm (1")	5/16-18 x 35mm	12mm	NOIR / BLACK	500
0134 - NR	38mm (1 1/2")	5/16-18 x 30mm	8mm	NOIR / BLACK	500

PATTES AJUSTABLES / ADJUSTABLE LEGS

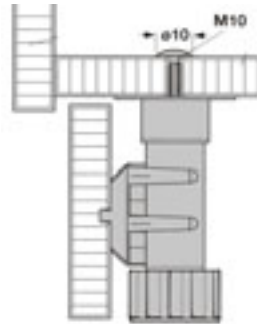
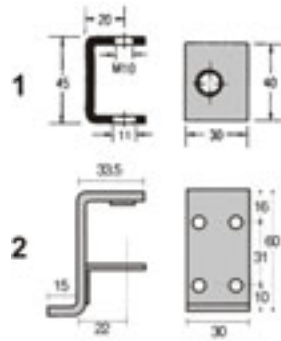
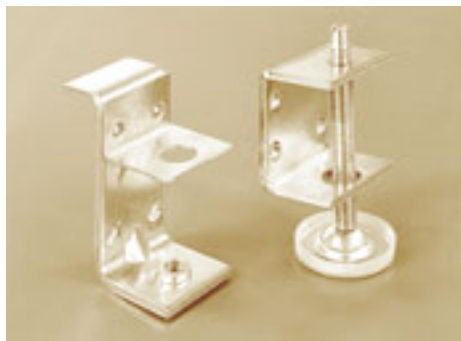
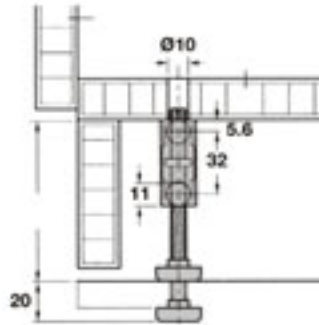







# QUINKO-TEK	COULEUR COLOR	DESCRIPTION	CAISSE CASE
130N - 64	NOIR - BLACK	pattes ajustable / leveler	500
133Z - 70	ZINC	sous patte M10 x 70mm glide M10 x 70mm	500
133B - CV	CLAIR / CLEAR	capuchon cover cap	1,000
1 133U - BK	ZINC	support "U" "U" bracket	500
2 133Z - BK	ZINC	support bracket	500
4402 - BL	BLANC / WHITE	niveleur ajustable 3 positions 100 - 120 - 150mm adjustable glide 3 positions 100 - 120 - 150mm	100
4404 - AD	ZINC	fixation pour base panel clip	100
888N - 28	NOIR / BLACK	patte ajustable 2 1/2" diam. adjustable leg 2 1/2" diam.	1
888N - 3	NOIR / BLACK	patte ajustable 3" diam. adjustable leg 3" diam.	1
888N - 6	NOIR / BLACK	patte ajustable 6" diam. adjustable leg 6" diam.	1
888CS - 28	INOX	patte ajustable 2 1/2" diam. adjustable leg 2 1/2" diam.	1









AUTRES GRANDEURS ET COULEURS DISPONIBLES SUR
COMMANDE SPÉCIALE

OTHER SIZES AND COLORS ARE AVAILABLE
ON SPECIAL ORDER





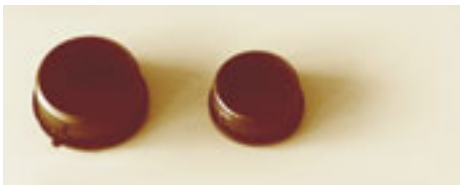

SOUS-PATTES / GLIDES

	# QUINKO-TEK	DIAM.	HAUTEUR HEIGHT	MAT.	COULEUR COLOR	FILET THREAD	CAISSE CASE
	132B - 3/4	19mm	25mm	plastique / plastic	BEIGE / BEIGE	1/4 - 20	500
	132N - 3/4	19mm	25mm	plastique / plastic	NOIR / BLACK	1/4 - 20	500
	132N - 25	25mm	25mm	plastique / plastic	NOIR / BLACK	1/4 - 20	500
	0134 - NR	38mm	30mm	plastique / plastic	NOIR / BLACK	5/16 - 18	500
	132N - 1-1/8	28mm	44mm	plastique / plastic	NOIR / BLACK	5/16 - 18	500
	134N - 26	26mm	38mm	plastique / plastic	NOIR / BLACK	5/16 - 18	500
	136N10/25 - 1/4	25mm	35mm	metal	NOIR / BLACK	1/4 - 20	1,000
	136N10/25 - 5/16	25mm	35mm	plastique metal plastic	NOIR / BLACK	5/16 - 18	1,000
	138G - 20	20mm	10mm	plastique	BLANC / WHITE	-	100
	138G - 24	24mm	10mm	feutre gris	BLANC / WHITE	-	100
	138G - 30	30mm	10mm	plastique gray felt	BLANC / WHITE	-	100
	131W - 50X16	16X50mm	5mm	plastique plastic	BLANC / WHITE	-	300

ROULETTES ET SOUS-PATTES CASTERS AND GLIDES

	# QUINKO-TEK	DIAM.	HAUTEUR HEIGHT	MATERIAL	COULEUR COLOR	CAPACITÉ CAPACITY	CAISSE CASE
	184GA - 75	2 7/8"	3 5/8"	PLASTIQUE / PLASTIC	GRIS ARGENTÉ / SILVER GRAY	200lbs	100
	184GA - 75F Frein / Brake	2 7/8"	3 5/8"			200lbs	100
	220S - 2	2"	2 1/2"	CAOUTCHOUC / RUBBER	NOIR / BLACK	80lbs	50
	220S - 25	2 1/2"	3 1/4"			80lbs	50
	220S - 3	3"	3 3/4"			80lbs	50
	220S - 4	4"	5"			80lbs	50
	220R - 2	2"	2 1/2"	CAOUTCHOUC / RUBBER	NOIR / BLACK	80lbs	50
	220R - 25	2 1/2"	3 1/4"			80lbs	50
	220R - 3	3"	3 3/4"			80lbs	50
	220R - 4	4"	5"			80lbs	50
	215SB - 2	2"	2 1/2"	CAOUTCHOUC / RUBBER	NOIR / BLACK	80lbs	50
	215SB - 3	3"	3 3/4"			80lbs	50
	44240034	# 240	3/4"	3/4"	NOIR / BLACK	5,000	
	44240078	# 240	7/8"	7/8"		3,400	
	44240100	# 240	1"	1"		2,500	
	44240118	# 240	1 - 1/8"	1 - 1/8"		1,600	
	44240114	# 240	1 - 1/4"	1 - 1/4"		1,500	
	44900058	# 9	3/8"	-	NOIR / BLACK	5,000	
	44900034	# 9	3/4"	-		4,200	
	44900078	# 9	7/8"	-		2,000	
	44900100	# 9	1"	-		1,600	
	44119114	# 119	1 - 1/4"	-	NOIR / BLACK	2,200	
	44119112	# 119	1 - 1/2"	-		1,300	
	49242200	# 242	3/4"	2"	NOIR / BLACK	1,100	

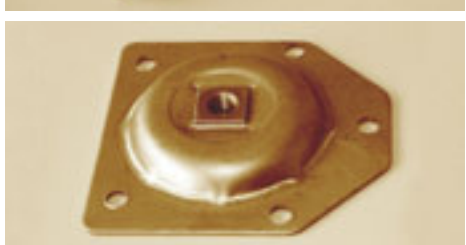
QUINCAILLERIE POUR PATTES / HARDWARE FOR LEGS

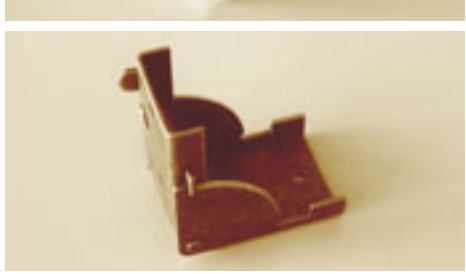
# QUINKO-TEK	FINI FINISH	CAISSE CASE
	207A - PL ACIER NATUREL / PLAIN STEEL	1,000 Equerres pour sous-pattes (fixation 2 vis) filets 1/4 - 20 <i>Leveller bracket 1/4 - 20 thread (2 screws mounting)</i>
	0208 - ZC ZINC / ZINC	1,000 Equerres de coin pour sous-pattes filets 5/16 - 18 <i>Corner bracket/ 5/16 - 18 thread</i>
	0201 - PL ACIER NATUREL / PLAIN STEEL	1,000 Ferrures de coin pour chaises <i>Corner brace for chairs</i>
	201M - PL ACIER NATUREL / PLAIN STEEL	1,000 Ferrures de coin pour tables <i>Corner brace for table</i>
	208P - PL ACIER NATUREL / PLAIN STEEL	1,000 Ferrure pour patte de chaise filets 5/16 - 18 <i>Leveller bracket 5/16 - 18 thread</i>
	207B - PL ACIER NATUREL / PLAIN STEEL	1,000 Equerres pour sous-pattes (fixation 4 vis) filets 1/4 - 20 <i>Leveller bracket 1/4 - 20 thread (4 screws mounting)</i>
	209F - BZ BRONZE / BRONZE	100 Ferrures pour pattes pliantes de table (pièce 1 - 1/2" x 1 - 1/2") <i>Folding table leg bracket (1 - 1/2" x 1 - 1/2" square part)</i>

BASES DE TABLE / TABLE BASES

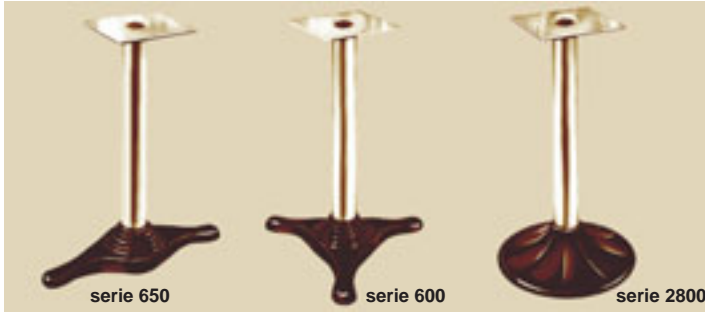

Bases de table en fonte
Cast iron tables bases



Base de table en acier
Steel table base



Pates pliantes pour tables
Folding legs for tables



Base de table en fonte
Cast iron table base



Bases de table en fonte
Cast iron table base



Base de table acier
Steel table base

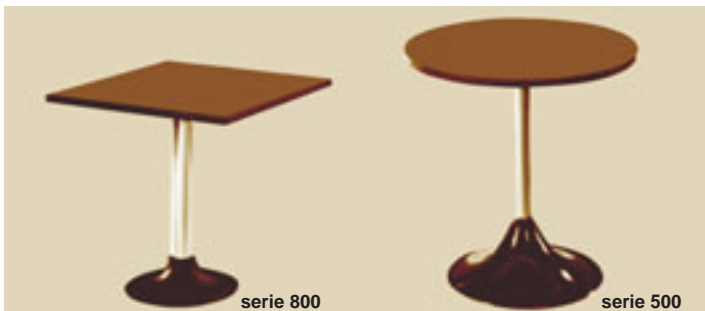

Bases de table en fonte
Cast iron table bases

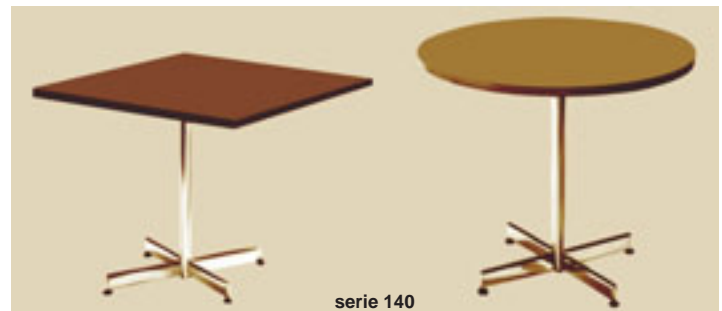

Bases de table acier
Steel table bases

BRAS DE SUSPENSION / LID SUPPORTS

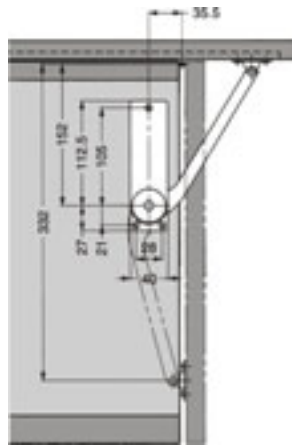
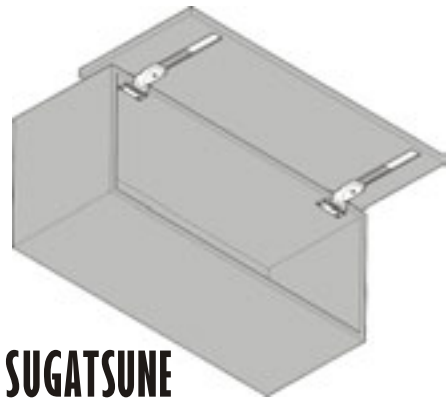

SUGATSUNE

# QUINKO-TEK	DESCRIPTION	CAISSE CASE
OVN3 - NR	OVER-THE-TOP-FLIPPER DOOR SOFT CLOSING AMORTISSEUR DE PORTES CONTROL MECHANISM FOR FLIPPER DOORS POUR PORTES DE 3 À 5 kgs FOR DOORS 3 TO 5 kgs COULISSE NON INCLUSE SLIDE NOT INCLUDED	20

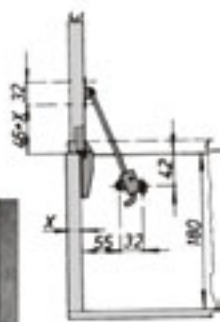
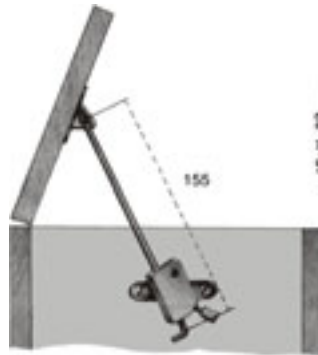

577D - BL	BRAS DE SUSPENSION LID SUPPORT MEMBRE DROIT RIGHT SIDE MEMBER	10
577G - BL	MEMBRE GAUCHE LEFT SIDE MEMBER COULEUR / COLOR : BLANC / WHITE CAPACITÉ / CAPACITY 4 KG.	10



0571 - BL	BRAS DE SUSPENSION BLANC LID SUPPORT WHITE	100
0571 - NR	BRAS DE SUSPENSION NOIR LID SUPPORT BLACK LONGUEUR / LENGTH : 224mm	100



0575 - LT	BRAS DE SUSPENSION AVEC ARRÊT EN POSITION OUVERTE LID SUPPORT WITH LOCK IN OPEN POSITION COULEUR / COLOR : LAITON / BRASS LONGUEUR / LENGTH : 152.4mm	100
-----------	--	-----

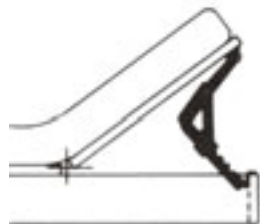
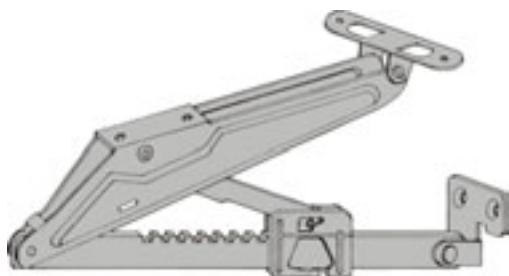

0245 - ZC	GENOUILÈRE À CRÉMAILLÈRE HEADBOARD MECHANISM COULEUR / COLOR : ZINC LONGUEUR / LENGTH : 210mm	100
-----------	--	-----

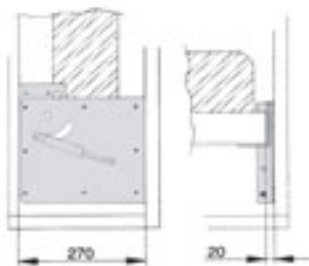
BRAS DE SUSPENSION / LID SUPPORTS

# QUINKO-TEK	DESCRIPTION	CAISSE CASE
241LT - BL	Mécanisme lit escamotable latéral avec cylinder a gas pour installation sans pieds <i>Self supporting and collapsible Bed mechanism with gas springs</i>	1
5724 - ZC	Ferrures pour portes escamotable de micro-ondes <i>Microwave door mechanism to lift the door</i>	1

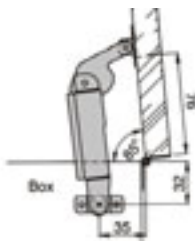

# QUINKO-TEK	COULEUR COLOR	DIMENSION	CAISSE CASE
0570 - NR	NOIR / BLACK	5 - 1/2"	100
Mécanisme de retenue pour panneau <i>Lift-up support</i>			
5721 - BL	BLANC / WHITE	250mm	25
Bras de retenue pour panneau <i>Lid in open position, lift slightly to release</i>			
5722 - BL	BLANC / WHITE	200mm	10
Bras de retenue pour panneau <i>Lid in open position, lift slightly to release</i>			
5723 - NR	NOIR / BLACK	260mm	25
Support de retenue avec action de freinage <i>Lid support with braking action</i>			

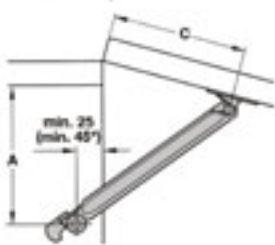
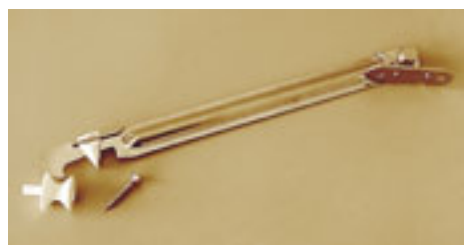
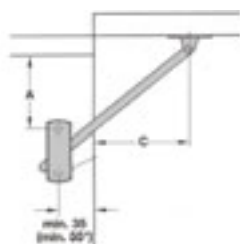

**BRAS DE SUSPENSION
LID SUPPORT**



# QUINKO-TEK	COULEUR COLOR	DIMENSION	CAISE CASE
0571 - BL 0571 - NR	BLANC / WHITE NOIR / BLACK		100 100
Bras de retenue # 571 <i>Lid support # 571</i>			

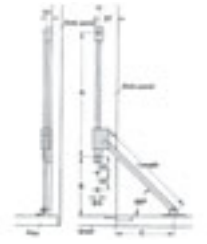

0576 - BL 0576 - NR	BLANC / WHITE NOIR / BLACK		100 100
Bras de retenue # 576 (256mm c/c) <i>Lid support # 576 (256mm c/c)</i>			



5725 - BZ	BRONZE / BRONZE		100
Bras de retenue 180dg en position ouverte <i>Folding stay with stop 180dg in open position</i>			



5726 - ZC	ZINC / ZINC		20
Bras de retenue 180dg en position ouverte <i>Folding stay with stop 180dg in open position</i>			



0575 - LT	LAITON / BRASS		500
# 574 bras de retenue sans frein / <i>Lid support without lock</i> # 575 bras de retenue avec frein / <i>Lid support with lock</i>			



5727Z - 130 5727Z - 250	ZINC / ZINC ZINC / ZINC	130mm 250mm	25 25
Bras de retenue action en position fermé ou ouvert <i>Lid stay, hold open or closed position</i>			



248Z - 8 248Z - 10	ZINC / ZINC ZINC / ZINC	8" 10"	100 100
Support de tablette avec ressort <i>Lid support with spring</i>			

SUPPORTS À TABLETTE / SHELF SUPPORTS

QUINKO-TEK

COULEUR
COLORCAISSE
CASE

0206 - LT

LAITON / BRASS

100

0206 - CH

CHROME / CHROME

100

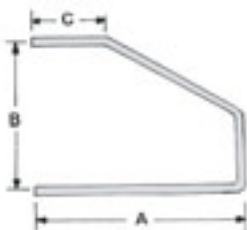
Séparateur à disque 135 x 185 x 5mm
Disc dividers 135 x 185 x 5mm

0205 - NR

NOIR / BLACK

100

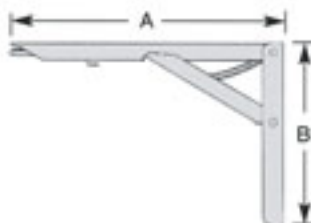
Séparateur à disque 135 x 185 x 5mm
Disc dividers 135 x 185 x 5mm

246Z - 250

250mm

30kg

ZINC (JAUNE)

10

246Z - 380

380mm

40kg

ZINC (YELLOW)

10

Support tablette pliantes
Folding brackets

209S - CH

CHROME / CHROME

50

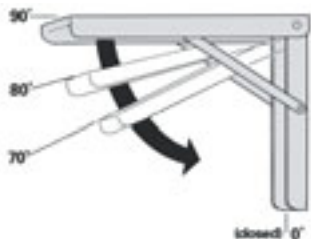
Support tablette tubulaire 3/4 x 12"
Tubular shelf bracket 3/4 x 12"

246Z - 12

12"

ZINC / ZINC

10

246Z - 16

16"

10

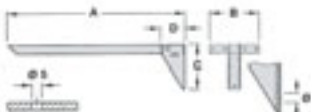
Support pliants en «L» pour tablette # 206
Folding "L"-shaped Brackets for shelf # 206

244B - 350

360mm

1

244B - 450

450mm

1

244B - 560

560mm

BRUN / BROWN

1

244B - 680

680mm

1

Support tablette extra-robuste capacité 300kg, ajustable 3 positions
Folding table bracket load capacity 300kg, 3-way adjustment

213B - 100

A

100mm

B

75mm

10

213B - 125

125mm

100mm

10

213B - 150

150mm

125mm

10

213B - 200

200mm

175mm

10

213B - 250

250mm

225mm

10

213B - 300

300mm

275mm







10

BLANC /
WHITE

Equerre en «L» / "L"-shaped brackets

Autres couleurs disponibles sur commande / Other colors available on order

CROCHETS A LINGE / COAT HOOKS

	# QUINKO-TEK	DIMENSION	COULEUR COLOR	MATERIAL MATÉRIEL	CAISSE CASE
	4671 - CH	1-1/2"	CHROME / CHROME	FONTE DIE CAST	100
	4671 - LT	1-1/4"	LAITON / BRASS	FONTE DIE CAST	100
	4672 - CH	3-1/4"	CHROME / CHROME	FONTE DIE CAST	100
	4672 - LT	3-1/4"	LAITON / BRASS	FONTE DIE CAST	100
	4673 - CH	3 - 1/2"	CHROME / CHROME	FONTE DIE CAST	100
	4673 - LT	X 2"	LAITON / BRASS	FONTE DIE CAST	100
	4674 - AN	18mm x 158mm	ANODIZE / ANODIZED	ALUMINIUM ALUMINUM	100
	4675 - LT	1-3/4"	LAITON / BRASS	LAITON MASSIF	40
	4675 - CH	X 1-1/2"	CHROME / CHROME	SOLID BRASS	40
	4676 - LT	8" x 2"	LAITON / BRASS	LAITON MASSIF	10
	4676 - CH	8" x 2"	CHROME / CHROME	SOLID BRASS	10

PLATEAUX PIVOTANTS / SWIVEL PLATES



# QUINKO-TEK	# TITUS	DESCRIPTION	MATERIEL MATERIAL	CAISSE CASE
698N - 12	5880LA	PLATEAU PIVOTANT 12" NOIR 12" BLACK TURNTABLE	PLAST.	150
698T - NR	5876LA	SUPPORT SEULEMENT POUR PLATEAU TRAY ONLY FOR TURNTABLE	PLAST.	100
698I - 10	05874ZN	INSERTION 10 x 12 mm POUR 698N - 12 10 x 12 mm INSERT FOR 698N - 12	PLAST.	2,000
698E - 10	02172NA	ÉCROU PIVOTANT POUR 698N - 12 PIVOT INSERT FOR 698N - 12	PLAST.	10,000
698A - 32	05877LA	ARRET NOIR POUR 698N - 12 BLACK STOP FOR 698N - 12	PLAST.	7,500



# QUINKO-TEK	FINI FINISH	DIMENSION	EXTENSION	CAPACITE CAPACITY	CAISSE CASE
0578 - 06	ZINC	6" x 6"	NON - NO	500 LBS	100
0578 - ZC	ZINC	4" x 4"	NON - NO	300 LBS	100



0579 - ZC	ZINC	12" ROND - 12" ROUND	NON - NO	1000 LBS	25
579Z - 09	ZINC	9" ROND - 9" ROUND	NON - NO	750 LBS	25

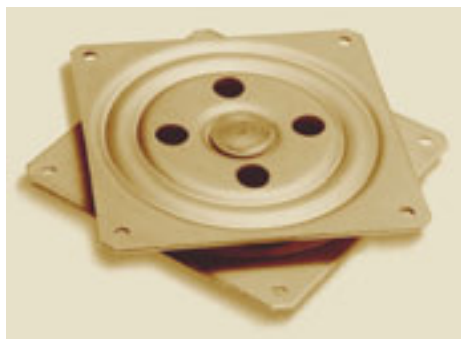

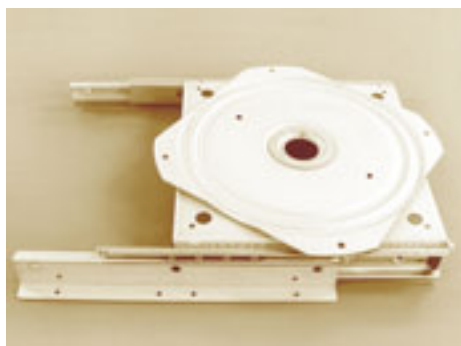

0606 - AC	ZINC	6" x 6"	NON - NO	200	15
-----------	------	---------	----------	-----	----

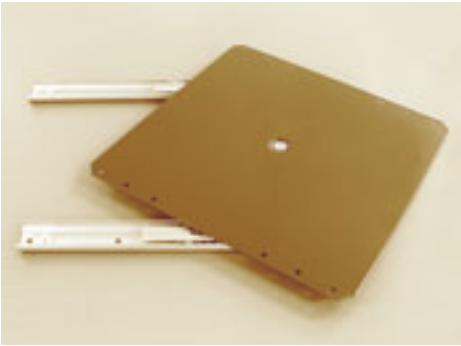
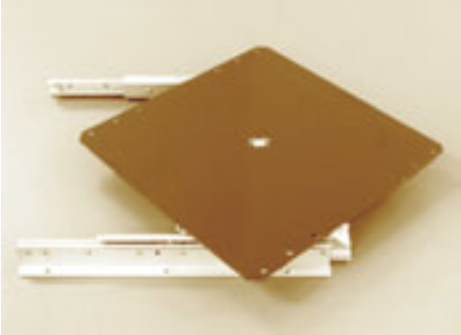

0586 - ZC	ZINC	325mm x 331mm x 54mm	220mm	110Lbs	10
-----------	------	-------------------------	-------	--------	----

PLATEAUX PIVOTANTS / SWIVEL PLATES

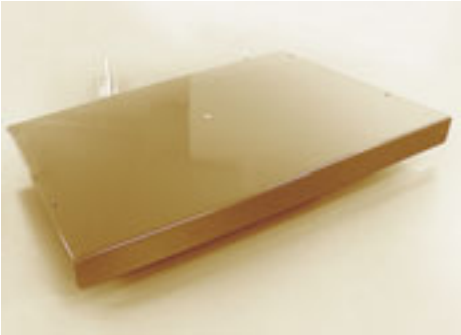
	# QUINKO-TEK	FINI FINISH	DIMENSION	EXTENSION	CAPACITE CAPACITY	CAISSE CASE
	0580 - BR	BRUN BROWN	320mm x 320mm x 24mm	225mm	90Lbs	10
	0581 - BR	BRUN BROWN	320mm x 320mm x 46mm	230mm	90Lbs	10
	0588 - ZC	ZINC	13" x 10 5/8" x 2 7/16"	9 5/8"	175 LBS	1
	0584 - BR	BRUN / BROWN	650mm x 370mm x 53mm	290mm	200 LBS	1
	3900 - 455 - 14	NOIR / BLACK	559mm x 344mm x 45mm	356mm	200 LBS	1

CRÉMAILLÈRES / WALL STANDARDS

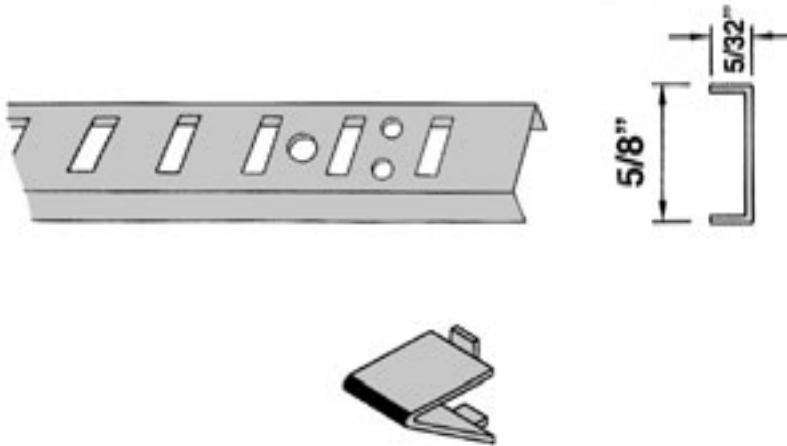

# QUINKO-TEK	COULEUR COLOR	LONG. LENGTH	CAISSE CASE
238B - 36	BLANC / WHITE	36"	10
238B - 60	BLANC / WHITE	60"	10
238B - 72	BLANC / WHITE	72"	10
238Z - 36	ZINC	36"	10
238Z - 60	ZINC	60"	10
238Z - 72	ZINC	72"	10
239B - ST	BLANC / WHITE	1"	100
239Z - ST	ZINC	1"	100

D'AUTRES MODÈLES DISPONIBLES SUR COMMANDE
OTHER MODELS AVAILABLE ON ORDER

PÔLES DE GARDE-ROBE / CLOSET RODS

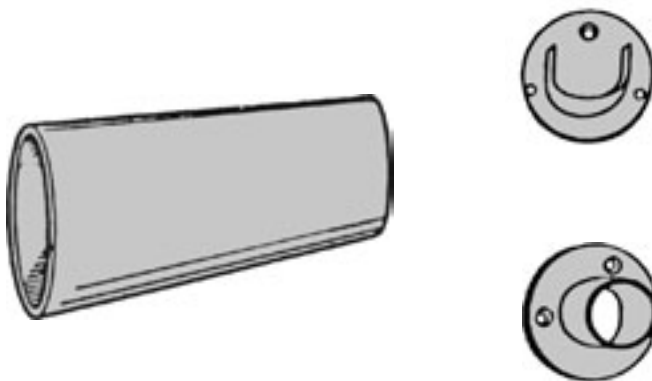

# QUINKO-TEK	COULEUR COLOR	DIAM.	LONG. LENGTH	CAISSE CASE
*0595 - 04	ZINC	1 1/4"	48"	5
*0595 - 05	ZINC	1 1/4"	60"	5
*0595 - 06	ZINC	1 1/4"	72"	5
0595 - 08	ZINC	1 1/4"	96"	5
*0595 - 10	ZINC	1 1/4"	120"	5
0595 - 12	ZINC	1 1/4"	144"	5

* DISPONIBLE SUR COMMANDE SPÉCIALE
* AVAILABLE ON SPECIAL ORDER

# QUINKO-TEK	DESCRIPTION	COULEUR COLOR	CAISSE CASE
0596 - OP	BAGUE OUVERTE OPEN BRACKET	ZINC	250
0596 - CL	BAGUE FERMÉE CLOSED BRACKET	ZINC	250

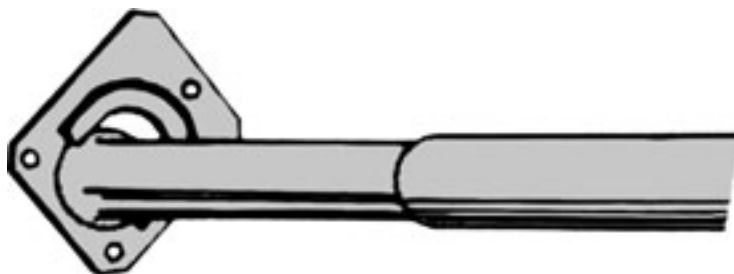

# QUINKO-TEK	COULEUR COLOR	DIAM.	LONG. LENGTH	CAISSE CASE
* V595 - ZC	ZINC	1"	18 - 30"	10
V596 - ZC	ZINC	1"	30 - 48"	10
* V597 - ZC	ZINC	1"	48 - 72"	10
* V598 - ZC	ZINC	1"	72 - 96"	10
* V599 - ZC	ZINC	1"	96 - 120"	10

* DISPONIBLE SUR COMMANDE SPÉCIALE
* AVAILABLE ON SPECIAL ORDER

POLES DE GARDE-ROBE / CLOSET RODS



# QUINKO-TEK	COULEUR COLOR	CAISSE CASE
0593 - BL	BLANC / WHITE	50

Pole garde-robe acier 18mm x 2.5m
Wardrobe pole 18mm x 2.5m



593B - OP	BLANC / WHITE	100
-----------	---------------	-----

Support pole a garde-robe
Wardrobe pole support

QUINCAILLERIE POUR CRÉMAILLÈRES/WALL STANDARD HARDWARE

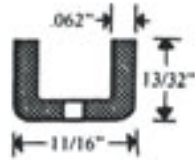

# QUINKO-TEK	FINI FINISH	LONGUEUR LENGTH	CAISSE CASE
232Z - 36	ZINC / ZINC	36"	10
232Z - 48		48"	10
232Z - 60		60"	10
232Z - 72		72"	10
232Z - 84		84"	10
232Z - 96		96"	10

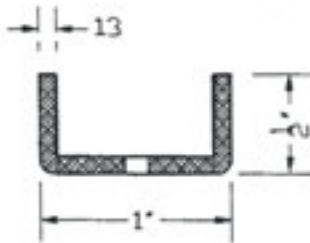

231Z - 36	ZINC / ZINC	36"	10
231Z - 48		48"	10
231Z - 60		60"	10
231Z - 72		72"	10
231Z - 84		84"	10
231Z - 96		96"	10

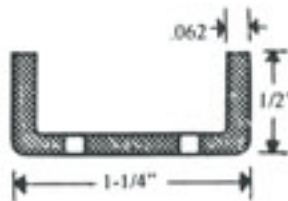







233Z - 48	ZINC / ZINC	48"	10
233Z - 60		60"	10
233Z - 72		72"	10
233Z - 84		84"	10
233Z - 96		96"	10







QUINCAILLERIE POUR CRÉMAILLÈRES/WALL STANDARD HARDWARE

	# QUINKO-TEK	FINI FINISH	LONGEUR LENGTH	CAISSE CASE
 	235ZHD - 8 *	ZINC / ZINC	8"	25
	235ZHD - 10 *		10"	25
	235ZHD - 12 *		12"	25
	235ZHD - 14 *		14"	25
	235ZHD - 16 *		16"	25
	235ZHD - 18 *		18"	25
	235ZHD - 20 *		20"	25
	235ZHD - 22 *		22"	25
	235ZHD - 24 *		24"	25
	* paire / pair			
 	235ZA - 8 *	ZINC / ZINC	8"	25
	235ZA - 10 *		10"	25
	235ZA - 12 *		12"	25
	235ZA - 14 *		14"	25
	235ZA - 16 *		16"	25
* paire / pair				
 	234Z - 6	ZINC / ZINC	6"	50
	234Z - 8		8"	50
	234Z - 10		10"	50
	234Z - 12		12"	50
	234Z - 14		14"	50
	234Z - 16		16"	50
 	235Z - 6	ZINC / ZINC	6"	25
	235Z - 8		8"	25
	235Z - 10		10"	25
	235Z - 12		12"	25
	235Z - 14		14"	25
	235Z - 16		16"	25
	* paire / pair			





**SUPPORTS SLATWALL
SLATWALL BRACKETS**

	# QUINKO-TEK	DESCRIPTION	FINIS FINISH	LONGEUR LENGTH	CAISSE CASE
	230SW - C6	Support pour SLATWALL simple <i>SLATWALL shelf bracket</i>	CHROME CHROME	6"	25
	230SW - C8			8"	25
	230SW - C10			10"	25
	230SW - C12			12"	25
	230SW - C14			14"	25
	230SW - C16			16"	25
	2311SW - C8 *	Support pour SLATWALL avec fixation pour tablette <i>SLATWALL shelf bracket with end stopper</i>	CHROME CHROME	8"	25
	2311SW - C10 *			10"	25
	2311SW - C12 *			12"	25
	2311SW - C14 *			14"	25
* paire / pair					
	230ASW - C8 *	Support pour SLATWALL ajustable 5 position <i>SLATWALL bracket with 5 level adjustment</i>	CHROME CHROME	8"	25
	230ASW - C10 *			10"	25
	230ASW - C12 *			12"	25
	230ASW - C14 *			14"	25
* paire / pair					
	230ISW - C1	Crochet pour SLATWALL tige 1/4" <i>SLATWALL hook 1/4" diam.</i>	CHROME CHROME	1"	100
	230ISW - C4			4"	100
	230ISW - C6			6"	100
	230ISW - C8			8"	100
	230ISW - C10			10"	100
	230ISW - C12			12"	100
	230ZSW - C12	Support pour SLATWALL avec embout de sécurité <i>SLATWALL bracket with safety cap</i>	CHROME CHROME	12"	100
	230SW - CH	Crochet pour SLATWALL <i>SLATWALL frame hook</i>	CHROME CHROME	-	100

**SUPPORTS SLATWALL
SLATWALL BRACKETS**

	# QUINKO-TEK	DESCRIPTION	FINIS FINISH	LONGEUR LENGTH	CAISSE CASE
	2304SW - C4	Crochet pour SLATWALL embout sécurité	CHROME CHROME	4"	100
	2304SW - C6	tige 1/4"		6"	100
	2304SW - C8			8"	100
	2304SW - C10	SLATWALL hook safety end		10"	100
	2304SW - C12	1/4" wire		12"	100
	2305SW - C7	Support SLATWALL 3/4" x 3/4" modèle cascade	CHROME	7" 3 attaches 3 hooks	25
	2305SW - C16	SLATWALL bracket 3/4" x 3/4" waterfall model	CHROME	16" 7 attaches 7 hooks	25
	2306SW - C12	Support SLATWALL 3/4" x 3/4" tube carré droit	CHROME	12"	25
	2306SW - C16	SLATWALL bracket 3/4" x 3/4" square tube	CHROME	16"	25
	2307SW - C16	Support SLATWALL modèle cascade 5 crochets 3/4" x 3/4" SLATWALL bracket waterfall model 5 hooks 3/4" x 3/4"	CHROME CHROME	16"	25
	2308SW - C6	Support SLATWALL tube 1/2" x 1 - 1/2"	CHROME	6"	25
	2308SW - C12	SLATWALL bracket 1/2" x 1 - 1/2" tube	CHROME	12"	25
	2309SW - C7	Support SLATWALL modèle cascade tube 1/2" x 1 - 1/2"	CHROME	7" 3 attaches 3 hooks	25
	2309SW - C16	SLATWALL bracket waterfall model 1/2" x 1 - 1/2" tube	CHROME	16" 7 attaches 7 hooks	25

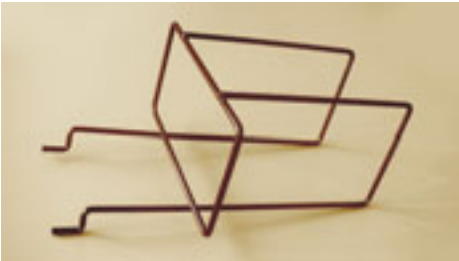
SUPPORTS SLATWALL ET ACCESSOIRES
SLATWALL BRACKETS AND ACCESSORIES

	# QUINKO-TEK	DESCRIPTION	FINIS FINISH	LONGEUR LENGTH	CAISSE CASE
	2312SW - C16	Support SLATWALL modèle cascade 1/2" x 1 - 1/2" SLATWALL bracket waterfall model 1/2" x 1 - 1/2" tube	CHROME CHROME	16"	25
	2313SW - C16	Support SLATWALL tube 1/2" x 1 - 1/2" 5 crochets SLATWALL bracket 1/2" x 1 - 1/2" tube 5 hooks	CHROME CHROME	16"	25
	2314SW - B4	Crochet pour SLATWALL tige 3/16" SLATWALL hook 3/16" wire	BLANC WHITE	4"	100
	2314SW - B6			6"	100
	2314SW - B8			8"	100
	2320SW - N7	Support SLATWALL pour littérature 4" - 1/2" L x 2 - 1/2" L	NOIR BLACK	7"	20
	2320SW - N9	SLATWALL bracket literature holder 4" - 1/2" L x 2 - 1/2" W		9"	20
	2321SW - C6	Support a littérature ajustable pour SLATWALL Adjustable literature supports for SLATWALL	CHROME CHROME	6"	100
	2322SW - B4	Paniers pour SLATWALL SLATWALL baskets	BLANC WHITE	12"x12"x4"	10
	2322SW - B8			12"x1"x8"	10
	2322SW - B6			12"x24"x6"	10

Q LINE

CROCHETS, CARRELAGE / HOOKS, EGGCRATE LOUVERS

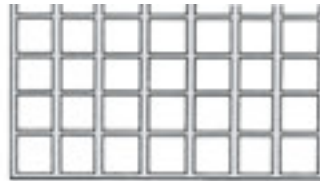
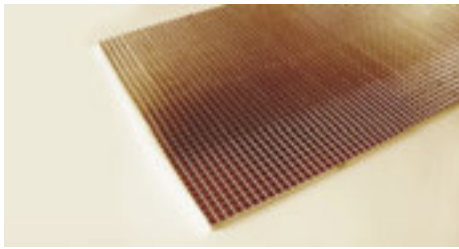

# QUINKO-TEK	COULEUR COLOR	CAISSE CASE
52448030	BLANC / WHITE	15
52448090	NOIR / BLACK	15
52448130	LAITON / BRASS	10
52448140	CHROME / CHROME	10

Carrelage pour éclairage 24" x 48"
Ceiling louvers 24" x 48"



56192930	BLANC / WHITE	50
----------	---------------	----

Moulure en L pour carrelage 1" x 1" x 96"
L moulding for ceiling panels 1" x 1" x 96"

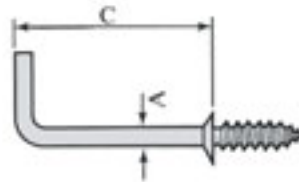

37102800	LAITON / BRASS	100
----------	----------------	-----

Crochets a vis avec épaulement 1"
Shoulder screws 1"

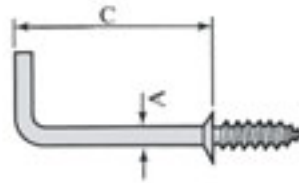

37103600	1 - 1/4"	ZINC / ZINC	100
37103500	1 - 1/2"	ZINC / ZINC	100

Crochets a cornice
Cornice screws

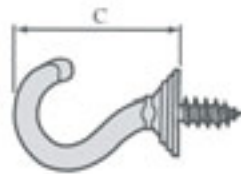

37103200	LAITON / BRASS	100
----------	----------------	-----

Crochets a tasse 7/8"
Cup hooks 7/8"

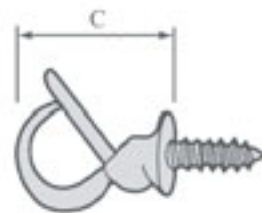

37105730	BLANC / WHITE	100
----------	---------------	-----

Crochets a tasse avec clips de sureté
Safely cup hooks



5061030	3/16"	LAITON / BRASS	250'
5061030	3/16"	CHROME / CHROME	250'
5061030	1/8"	LAITON / BRASS	250'
5061030	1/8"	CHROME / CHROME	250'
5061030	1/8"	LAITON / BRASS	100'
5061030	1/8"	CHROME / CHROME	100'
5061030	3/16"	LAITON / BRASS	100'
5061030	3/16"	CHROME / CHROME	100'

Chaîne a bille avec attaches
Ball chain with attachments

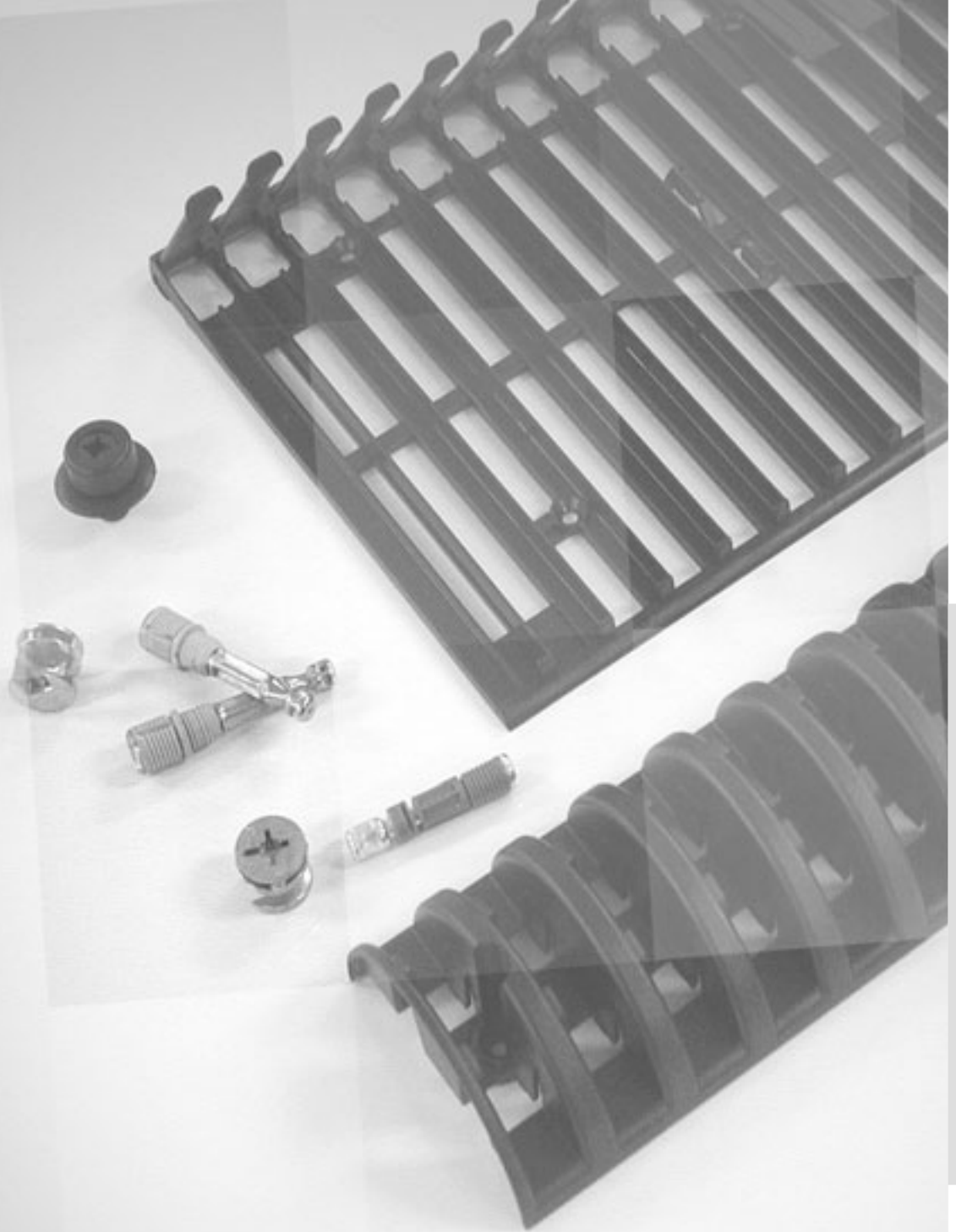

5



Titus 1

SYSTÈMES D'ASSEMBLAGE ASSEMBLY SYSTEMS

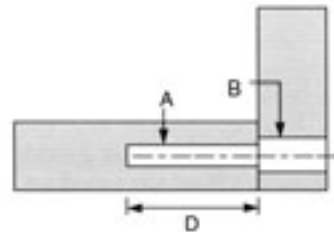
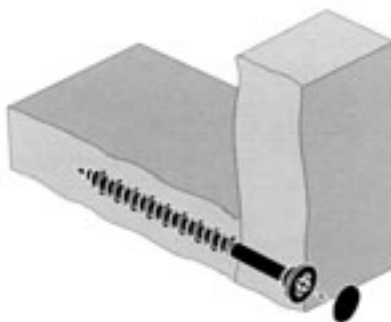
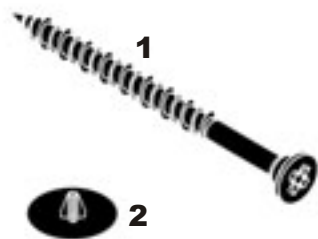

#	# QUINKO-TEK	# TITUS	DESCRIPTION	A	B	D	CAISSE CASE
1	0518 - 19	00066PH	vis d'assemblage "HiLo" / HiLo screw : 4 x 19mm No 8 pozidrive	3	5	9	12,500
1	0518 - 25	00062PH	vis d'assemblage "HiLo" / HiLo screw : 4 x 25mm No 8 pozidrive	3	5	9	10,500
1	0518 - 33	00071PH	vis d'assemblage "HiLo" / HiLo screw : 4 x 33mm No 8 pozidrive	3	5	9	7,000
1	0518 - 38	06074PH	vis d'assemblage "HiLo" / HiLo screw : 4 x 38mm No 8 pozidrive	3	5	9	4,000
1	0518 - HF	00077PH	vis d'assemblage "HiLo" / HiLo screw : 4 x 45mm No 8 pozidrive	3	5	9	3,000
1	0518 - 50	06077PH	vis d'assemblage "HiLo" / HiLo screw : 4 x 50mm No 8 pozidrive	3	5	9	5,000
2	0517 - BL	01020WA	cache vis blanc / white cover cap : 13mm pozidrive	-	-	-	50,000
2	0517 - NR	01020LA	cache vis noir / black cover cap : 13mm pozidrive	-	-	-	50,000
2	0517 - AM	01020AT	cache vis amande / almond cover cap : 13mm pozidrive	-	-	-	50,000
2	0517 - BR	01020KA	cache vis brun / brown cover cap : 13mm pozidrive	-	-	-	50,000
2	0517 - CN	01020CA	cache vis chêne / oak cover cap : 13mm pozidrive	-	-	-	50,000
2	0517 - GR	01020GR	cache vis gris / grey cover cap : 13mm pozidrive	-	-	-	50,000

Titus 1

SYSTÈMES D'ASSEMBLAGE ASSEMBLY SYSTEMS



#	# QUINKO-TEK	# TITUS	DESCRIPTION	A	B	D	CAISSE CASE
1	0516 - NR	01056LA	goujons d'assemblage pour vis / assembly barrel nut for : 0518 screws	12	7,5/8	11	10,000
1	0516 - BL	01056WA	goujons d'assemblage pour vis / assembly barrel nut for : 0518 screws	12	7,5/8	11	10,000

Titus 1

SYSTÈMES D'ASSEMBLAGE ASSEMBLY SYSTEMS

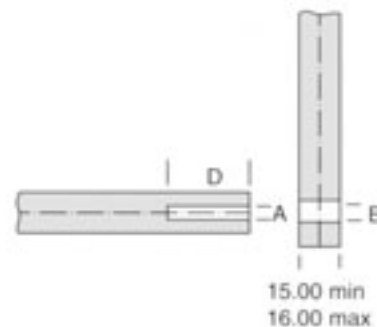
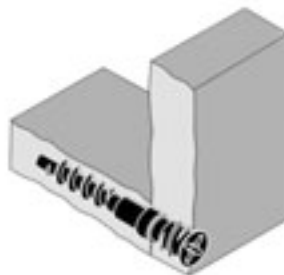
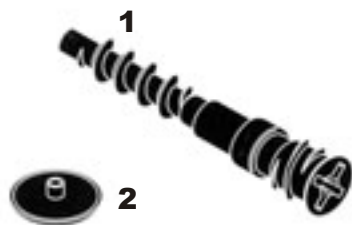

#	# QUINKO-TEK	# TITUS	DESCRIPTION	A	B	C	CAISSE CASE
1	0515 - 42	00180ZN	vis d'assemblage filet double / double locking screw : 6 x 42mm	5	7/7.5	30	2,500
2	0515 - NR	01042LA	cache vis noir / black cover cap : 13mm hex drive	-	-	-	50,000
2	0515 - BL	01042WA	cache vis blanc / white cover cap : 13mm hex drive	-	-	-	50,000



Titus 3

SYSTÈMES D'ASSEMBLAGE ASSEMBLY SYSTEMS

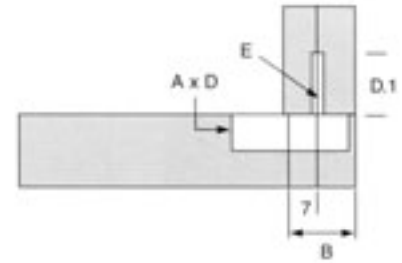
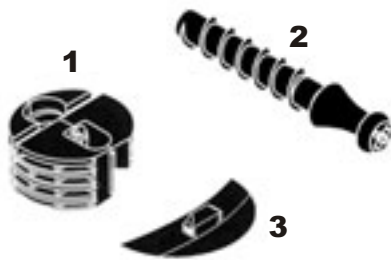

#	# QUINKO-TEK	# TITUS	DESCRIPTION	A	D	B	D.1	E	CAISSE CASE
1	0684 - BL	03118WA	boîtier d'assemblage blanc / white full depth housing assembly	25	125	$x-y$ $+7$	-	-	2,500
1	0684 - NR	03118LA	boîtier d'assemblage noir / black full depth housing assembly	25	125	$x-y$ $+7$	-	-	2,500
2	0685 - 05	03168ZN	douille d'assemblage Euro / dowel screw-in Euro thread : 5 x 25mm	-	-	-	30	5	2,500
3	0686 - BL	03150WA	capuchon demi lune blanc / white half moon cap	-	-	-	-	-	10,000
3	0686 - NR	03150LA	capuchon demi lune noir / black half moon cap	-	-	-	-	-	10,000

Titus 4

SYSTÈMES D'ASSEMBLAGE FLUSHBLOC & FLUSHFIX FLUSHBLOC & FLUSHFIX ASSEMBLY SYSTEMS

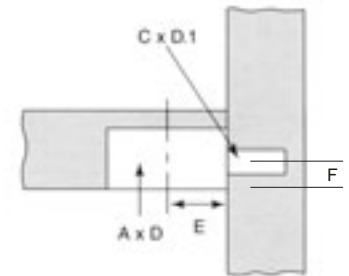
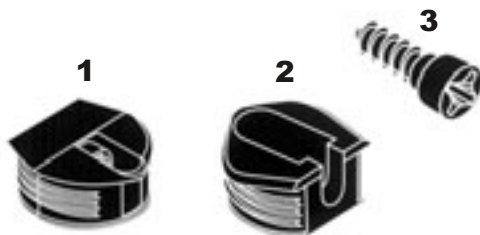

#	# QUINKO-TEK	# TITUS	DESCRIPTION	A	D	C	D.1	E	F	CAISSE CASE
1	0687 - BL	02164WA	boîtier d'assemblage blanc / white flushbloc assembly	25	11	-	-	12	4.5	2,500
1	0687 - NR	02164LA	boîtier d'assemblage noir / black flushbloc assembly	25	11	-	-	12	4.5	2,500
2	0688 - BL	02161WA	boîtier d'assemblage blanc / white flushfix assembly	25	11	-	-	12	4.5	2,500
2	0688 - NR	02161LA	boîtier d'assemblage noir / black flushfix assembly	25	11	-	-	12	4.5	2,500
2	0688 - BR	02161KA	boîtier d'assemblage brun / brown flushfix assembly	25	11	-	-	12	4.5	2,500
3	0689 - 05	00022ZN	vis Euro zinc / zinc Euro screw : 5 x 13mm	-	-	5	13	-	4.5	4,000

Titus 4

SYSTÈMES D'ASSEMBLAGE MINIBLOC & TWINBLOC MINIBLOC & TWINBLOC ASSEMBLY SYSTEMS

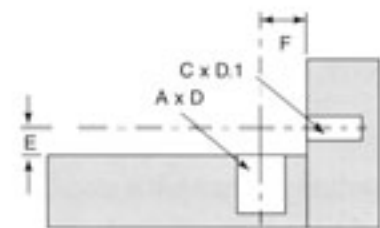
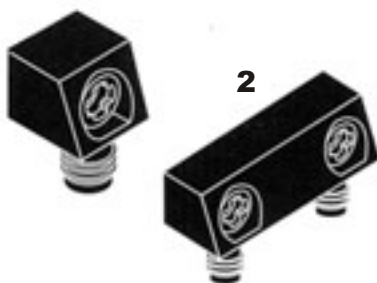

#	# QUINKO-TEK	# TITUS	DESCRIPTION	A	D	C	D.1	E	F	CAISSE CASE
1	0697 - BL	2120WA	bloc d'assemblage simple blanc / white mini-block assembly fitting	10	11	5	10.5	11	6	2,500
1	0697 - NR	2120LA	bloc d'assemblage simple noir / black mini-block assembly fitting	10	11	5	10.5	11	6	2,500
2	697D - BL	2139WA	bloc d'assemblage double blanc / white twin block assembly fitting	10	11	5	10.5	11	6	1,000
2	697D - NR	2139LA	bloc d'assemblage double noir / white black block assembly fitting	10	11	5	10.5	11	6	1,000



Titus 5

BOÎTIER 2000 CAM 2000



#	# QUINKO-TEK	# TITUS	DESCRIPTION	A	D	B	CAISSE CASE
1	0692 - 9.5	05913ZN	boîtier zinc / cam kliz zinc : 12 x 9.5mm pozi drive	12	10	5.5	2,000
1	692N - 9.5	05913LA	boîtier noir / cam kliz black : 12 x 9.5mm pozi drive	12	10	5.5	2,000
1	692C - 9.5	05576ZN	boîtier zinc / cam kliz zinc : 12 x 9.9mm pozi drive	12	10.5	5.5	2,000
1	692C - 12	05654ZN	boîtier zinc / cam kliz zinc : 15 x 12mm multi drive	15	12.5	7.5/8	2,000
1	692N - 12	05654LA	boîtier noir / cam kliz black : 15 x 12mm multi drive	15	12.5	7.5/8	2,000
1	692C - 13.5	05656ZN	boîtier zinc / cam kliz zinc : 15 x 13.5mm pozi drive	15	14	9	2,000
1	692N - 13.5	05656LA	boîtier noir / cam kliz black : 15 x 13.5mm pozi drive	15	14	9	2,000
1	692C - 15.5	05657ZN	boîtier zinc / cam kliz zinc : 15 x 15.5mm pozi drive	15	16	11	2,000
2	0694 - BL	01017WA	cache boîtier hex. 17mm blanc / white hex. cam cover cap 17mm	-	-	-	25,000
2	0694 - NR	01017LA	cache boîtier hex. 17mm noir / black hex. cam cover cap 17mm	-	-	-	25,000
2	0694 - CC	-	cache boîtier hex. 17mm graphite / charcoal hex. cam cover cap 17mm	-	-	-	25,000
2	0694 - CG	-	cache boîtier hex. 17mm cognac / cognac hex. cam cover cap 17mm	-	-	-	25,000
2	0694 - CN	-	cache boîtier hex. 17mm chêne / oak hex. cam cover cap 17mm	-	-	-	25,000
2	0694 - GP	-	cache boîtier hex. 17mm gris / grey hex. cam cover cap 17mm	-	-	-	25,000
2	0694 - MI	-	cache boîtier hex. 17mm acajou / mahogany hex. cam cover cap 17mm	-	-	-	25,000
2	0694 - IV	-	cache boîtier hex. 17mm ivoire / ivory hex. cam cover cap 17mm	-	-	-	25,000
3	694C - BL	01026 - WA	cache boîtier univ. 17mm blanc / white univ. cam cover cap 17mm	-	-	-	25,000
3	694C - NR	01026 - LA	cache boîtier univ. 17mm noir / black univ. cam cover cap 17mm	-	-	-	25,000

Titus 5

DOUILLES QUICKFIT QUICKFIT DOWELS

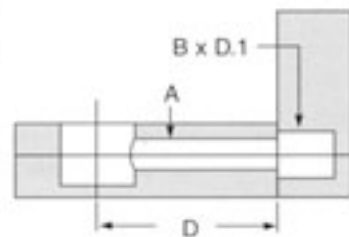
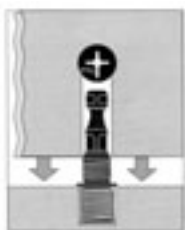

#	# QUINKO-TEK	# TITUS	DESCRIPTION	A	D	B	D.1	CAISSE CASE
1	0692 - QF	05810ZA	douille "quickfit" / "quickfit" dowel : 24 x 10mm	8	24	10	12	2,000
1	692Q - 34	05771ZA	douille "quickfit" / "quickfit" dowel : 34 x 10mm	8	34	10	12	2,000
1	* 692Q - 24/8	05563ZA	douille "quickfit" / "quickfit" dowel : 24 x 8mm	8	24	8	12	2,000
1	* 692Q - 34/8	05554ZA	douille "quickfit" / "quickfit" dowel : 34 x 8mm	8	34	8	12	2,000

* DISPONIBLE SUR COMMANDE SPÉCIALE / AVAILABLE ON SPECIAL ORDER

Titus 5

DOUILLES QUICKFIT TL2 QUICKFIT TL2 DOWELS

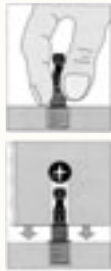

LE NOUVEAU TL 2 VOUS PERMET D'INSÉRER LA DOUILLE SOIT DANS LE TROU MENANT A L'EXCENTRIQUE, SOIT DANS LE TROU SUR LE PANNEAU QUI REÇOIT LA DOUILLE. DANS LES DEUX CAS UN ENGAGEMENT COMPLÈT ET SECURITAIRE EST ASSURÉ.

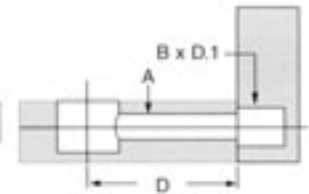

THE NEW TL 2 PERMITS THE USER TO INSERT THE DOWEL IN THE HOLE LEADING TO THE CAM, OR IN THE HOLE RECEIVING THE DOWEL. IN EITHER CASE COMPLETE AND SECURE ENGAGEMENT WILL BE POSSIBLE.

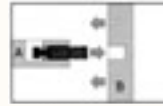

PERMET UNE TOLERANCE DE + 2mm, - 1mm BORD AU CENTRE DE TROU, SUR OPERATION DE PERÇAGE / PROVIDES A TOLERANCE OF + 2mm, - 1mm EDGE TO HOLE CENTER DRILLING

#	# QUINKO-TEK	# TITUS	DESCRIPTION	A	D	B	D.1	CAISSE CASE
1	692T2 - 24/8	5441YA	douille "quickfit TL 2" / "quickfit TL 2" dowel : 24 x 8mm	8	24 (23 -26)	8	12	2,000
1	692T2 - 34/8	5474YA	douille "quickfit TL 2" / "quickfit TL 2" dowel : 34 x 8mm	8	34 (33 - 36)	8	12	2,000
1	692T2 - 24/5	5453YA	douille "quickfit TL 2" / "quickfit TL 2" dowel : 24 x 5mm	8	24 (23 - 26)	5	12	2,000
1	692T2 - 34/5	5503YA	douille "quickfit TL 2" / "quickfit TL 2" dowel : 34 x 5mm	8	34 (33 - 36)	5	12	2,000

Titus 5

DOUILLES D'ASSEMBLAGE ASSEMBLY DOWELS

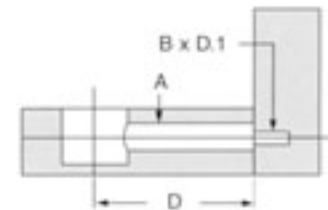

#	# QUINKO-TEK	# TITUS	DESCRIPTION	A	D	B	D.1	CAISSE CASE
1	0693 - 06	05996ZN	douille / dowel klix : 24 x 6 x 8.5mm Euro thread	6-7	24	5	8-5	2,000
1	0693 - 07	05919ZN	douille / dowel klix : 24 x 7 x 12mm Euro thread	7-8	24	5	12	2,000
1	0693 - 08	05987ZN	douille / dowel klix : 24 x 6 x 12mm Euro thread	6-7	24	5	12	2,000
1	0693 - M6	05746ZN	douille / dowel klix : 24 x 7 x 11.5mm M6 thread	7-8	24	M6	12	2,000
1	0693 - 33.5	05838ZN	douille / dowel klix : 33.5 x 7mm Euro thread	7-8	33.5	5	12	2,000
1	0693 - ZC	05534ZN	douille / dowel klix : 34 x 7mm Euro thread	7-8	34	5	12	2,000
1	693I - M6	05952ZI	douille / dowel klix : 34 x 7mm M6 thread	6-7	34	M6	-	2,000
2	692I - M6	02175YB	écrou type "D" 9 x13 M6 insert	-	-	9	13.5	4,000
3	683I - TS	02182NA	goujon / dowel	-	-	10	12	10,000

Titus 5

DOUILLES PLIANTES ET DOUBLES HINGED AND DOUBLE END DOWELS

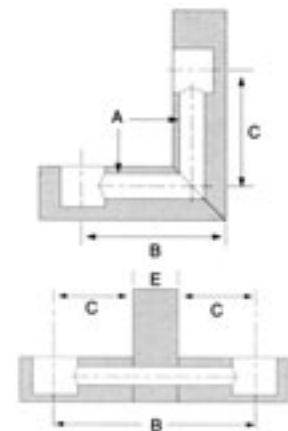
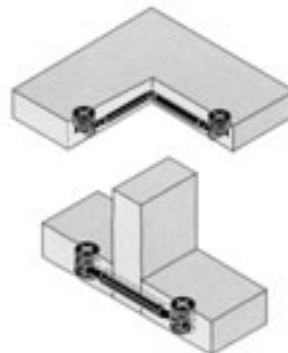
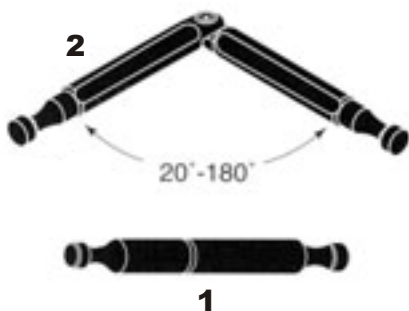

#	# QUINKO-TEK	# TITUS	DESCRIPTION	A	D	C	E	CAISSE CASE
1	693D - ZC	05929ZN	douille double / double dowel : 48 x 7mm	7-8	48	-	-	2,000
1	693D - 84	05858ZI	douille double / double dowel : 84 x 7mm	7-8	84	34	16	2,000
2	0696 - ZC	05860ZN	douille pliante / dowel hinged : 44 x 7mm	7-8	44	-	-	2,000

Titus 5

SYSTÈMES D'ASSEMBLAGE BEDFIX BEDFIX ASSEMBLY SYSTEMS

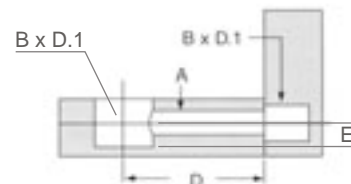

#	# QUINKO-TEK	# TITUS	DESCRIPTION	A	B	D	D.1	E	CAISSE CASE
1	692B - 20	5409ZN	boîtier / cam : 20 x 12mm pozi drive	-	20	-	12	6	1,000
2	693B - 34/8	5410ZN	douille / dowel : 34 x 8mm Euro	8	10	34	13.5	-	1,000

Titus 6

SYSTÈMES D'ASSEMBLAGE CAMFIX CAMFIX ASSEMBLY SYSTEMS

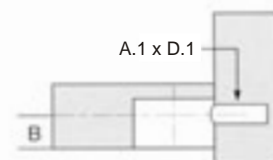
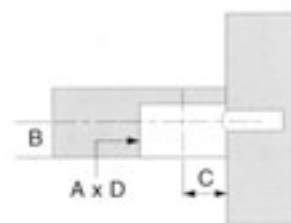
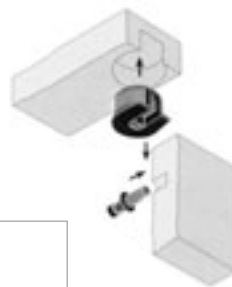

#	# QUINKO-TEK	# TITUS	DESCRIPTION	A	A.1	D	D.1	B	C	CAISSE CASE
1	676CD - NR	6431LA	boîtier expendo façade / drop-on expendo housing	20	-	12.5	-	-	9.5	2,000
2	676CS - NR	6435LA	boîtier expendo côté / side-on expendo housing	20	-	12.5	-	-	9.5	2,000
3	676QF - NR	6471LA	boîtier expendo quickfit / quickfit expendo housing	20	-	12.5	-	-	9.5	2,000
4	679CV - ZC	6406ZN	vis d'assemblage / assembly screw	-	5	-	11.5	-	-	4,000
5	679QF - 05	6408ZA	douille quickfit / quickfit dowel	-	5	-	12	-	-	4,000
5	679QF - 08	6410ZA	douille quickfit / quickfit dowel	-	8	-	12	-	-	4,000

Titus 7

SYSTÈMES D'ASSEMBLAGE CONTRACT FIX CONTRACT FIX ASSEMBLY SYSTEMS

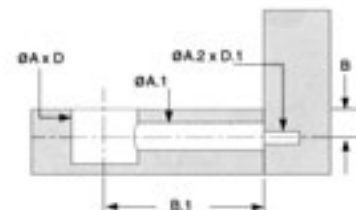

#	# QUINKO-TEK	# TITUS	DESCRIPTION	A	A.1	A.2	D	D.1	B	B.1	CAISSE CASE
1	0680 - ZC	05917ZN	vis d'assemblage / grub screw	15	-	-	12.5/14	-	7.5/9	-	1,000
2	0681 - ZC	05960ZN	boîtier / housing : 15 x 12mm	15	-	-	12.5/14	-	7.5/9	-	1,000
3	0682 - ZC	05970ZI	douille Euro / Euro dowel : 34 x 7mm	-	7/8	5	-	11.5	-	34	1,000
3	682D - M6	05971ZI	douille / dowel : M6 34 x 7mm	-	7/8	-	-	-	-	34	1,000
4	692I - M6	02175YB	Euro type "D" 9 x 13mm M6 insert	-	-	9	-	13.5	-	-	2,000

Titus 10

SYSTÈME D'ARRÊT POUR TABLETTE TILT TILT STOP SLIDING SHELF FITTING

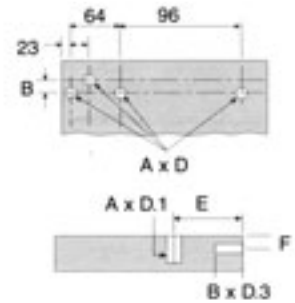
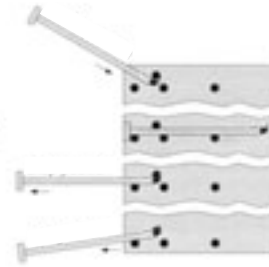

#	# QUINKO-TEK	# TITUS	DESCRIPTION	A	D	D.1	D.3	E	F	CAISSE CASE
1	0690 - NR	00900LA	roulette noire / black wheel runner : 16 x 8mm	8	11	-	-	-	-	4,000
2	671N - TS	04316LA	arrêt de tablette noir / black shelf tilt stop fitting	8	11	12.5	13	20	7.5	250

Titus 10

AJUSTEUR DE FAÇADE TIROIR DRAWER FRONT ADJUSTER

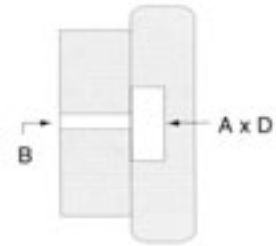
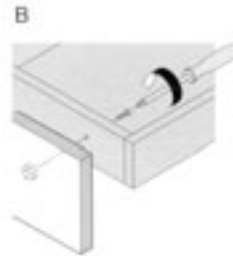
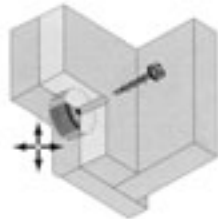

#	# QUINKO-TEK	# TITUS	DESCRIPTION	A	D	B	CAISSE CASE
1	0691 - BR	06309KA	ajusteur de façade brun / brown drawer front adjuster	25	12.5	5	5,000

Titus 20

RETENEUR DE PANNEAUX BACKFIX BACKBOARD BACKFIX

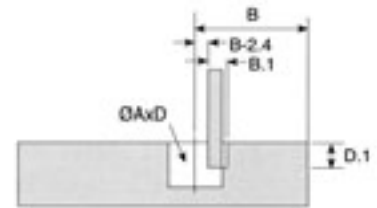
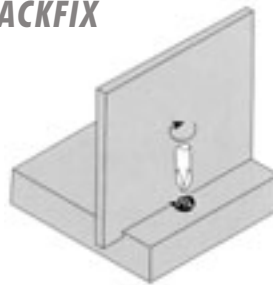
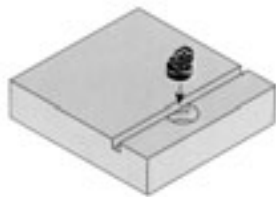

#	# QUINKO-TEK	# TITUS	DESCRIPTION	A	D	D.1	B	B.1	CAISSE CASE
1	0676 - ZC	02147	boîtier / housing : "backfix"	12	10	6	18	2.4	2,000

Titus 20

TRIMFIX TRIMFIX



#	# QUINKO-TEK	# TITUS	DESCRIPTION	D	D.1	B	CAISSE CASE
1	0679 - NR	01370LA	trimfix	5	4/4.4	10	2,000

Titus 15

SYSTEME DE RANGEMENT CD MEDIA STORAGE RACK

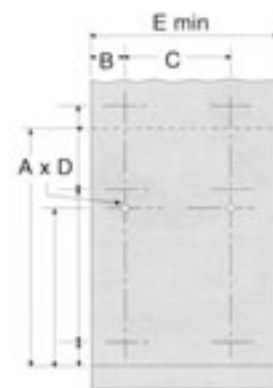
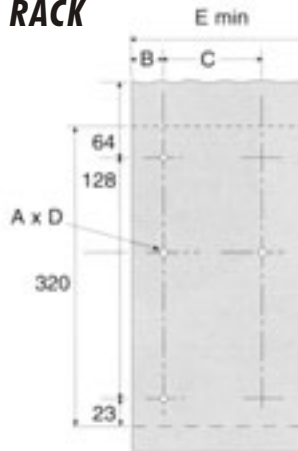
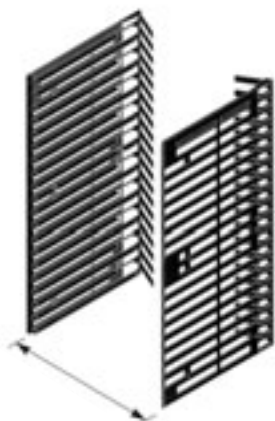

#	# QUINKO-TEK	# TITUS	DESCRIPTION	A	D	B	C	E	CAP.	CAISSE CASE
1	695N - 10	04229LA	support CD / CD holder	5	8	36	96	160	10	100
1	695N - 20	04304LA	support CD / CD holder	5	8	37	96	160	20	100

Titus 15

PORTE CD MULTIFIT & PENPAL MULTIFIT CD HOLDER & PENPAL

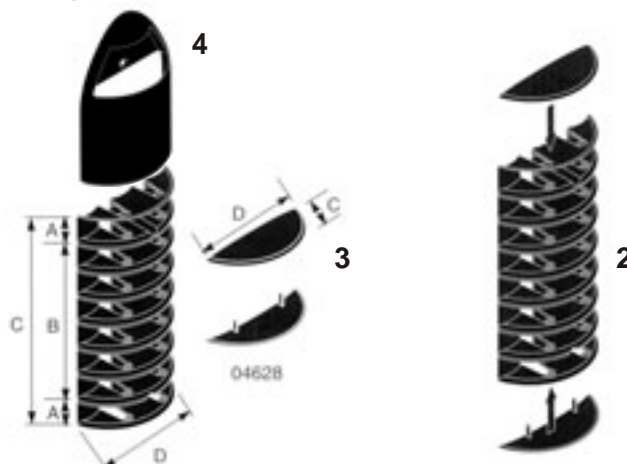
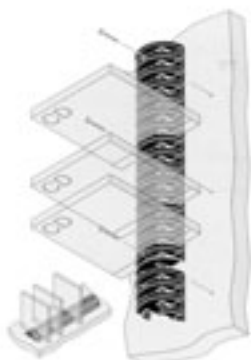
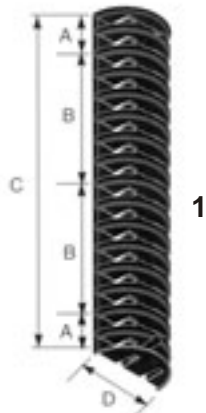

#	# QUINKO-TEK	# TITUS	DESCRIPTION	A	B	C	D	CAP.	CAISSE CASE
1	0675 - NR	04301LA	support CD multifit / multifit CD holder	16	128	288	65	15	100
2	675N - 08	04611LA	support CD multifit / multifit CD holder	16	128	160	80	8	200
3	675N - CP	04628LA	couverts décoratifs (2 / sac) / decorative caps (2 / bag)	-	-	7.85	80	-	200
4	675N - PC	08460LA	porte crayon / pen holder "Penpal"	-	-	7.85	80	-	100

Titus 15

PORTE CD/DVD MULTIFIT MULTIFIT CD/DVD HOLDER

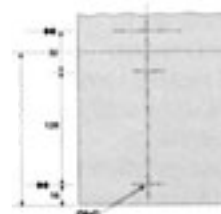
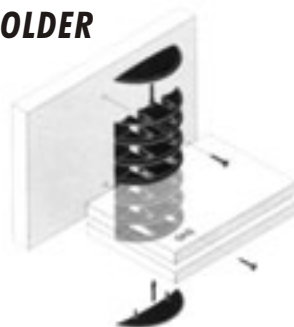
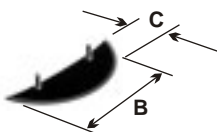
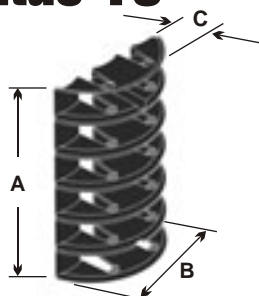

#	# QUINKO-TEK	# TITUS	DESCRIPTION	A	B	C	CAP.	CAISSE CASE
1	675N - DVD	04637LA	support CD/DVD multifit / multifit CD/DVD holder	153.4	65.4	32	6	
2	675N - DCP	04639LA	couverts décoratifs (2 / sac) / decorative caps (2 / bag)	-	65.4	32	-	



Titus 15

SYSTEME DE RANGEMENT CD MEDIA STORAGE RACK

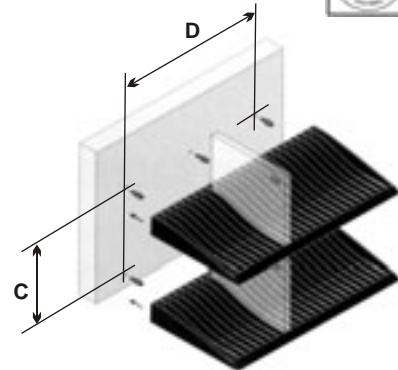
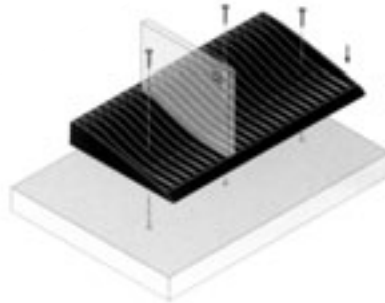
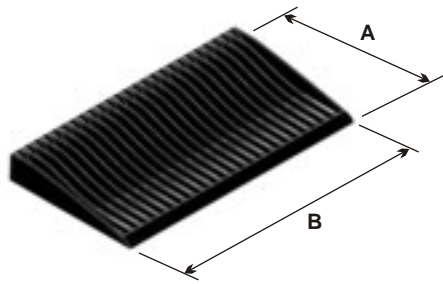

#	# QUINKO-TEK	# TITUS	DESCRIPTION	A	B	C	D	CAP.	CAISSE CASE
1	671N - CD	04478LA	support CD / CD holder	175	320	150	256	25	100

Titus 15

SYSTEME DE RANGEMENT DVD DVD MEDIA STORAGE RACK

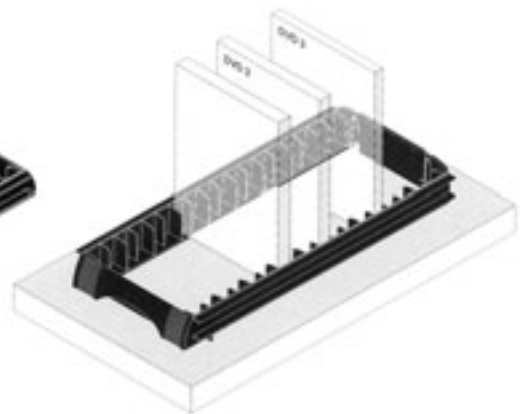
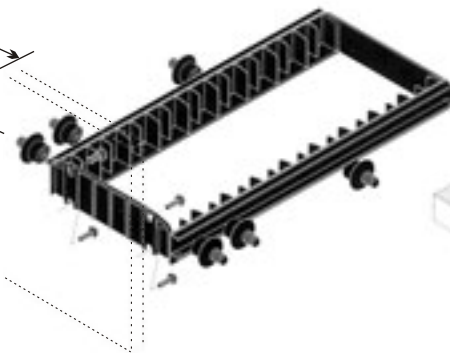
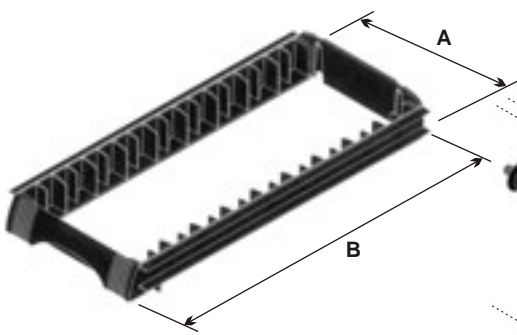

#	# QUINKO-TEK	# TITUS	DESCRIPTION	A	B	CAISSE CASE
1	672N - 40	04481LA	support DVD / DVD holder	165	350	100

Titus 15

SYSTEME DE RANGEMENT MEDIA STORAGE RACK

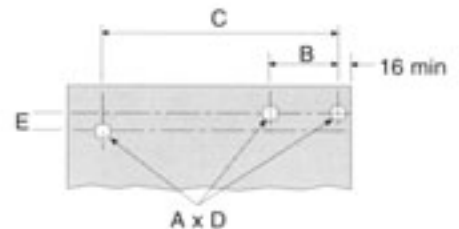
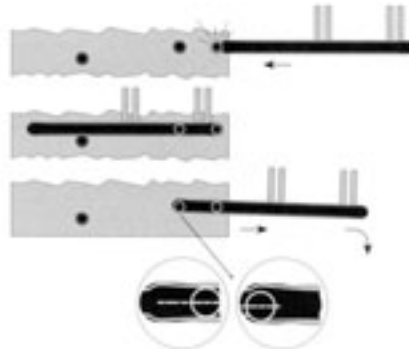
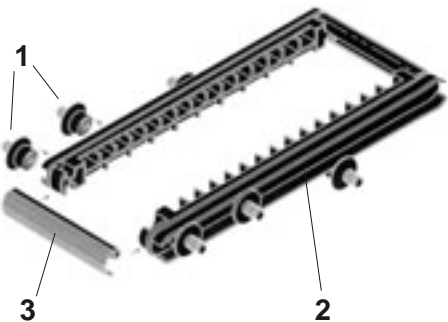

#	# QUINKO-TEK	# TITUS	DESCRIPTION	A	D	B	C	E	CAISSE CASE
1	0690 - NR	00900LA	roulette noire 16 x 8 / black wheel runner	8	11	32/64	224	20	4,000
2	674N - 14	04334LA	plateau coulissant / sliding tray	-	-	-	-	-	50
3	673S - NR	04418LA	couvert décoratif / decorative retainer	-	-	-	-	-	50



ATTACHES / FASTENERS

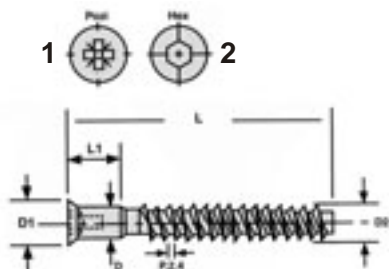

T	# QUINKO-TEK	COULEUR COLOR	DIM.	L	L1	D1	D2	D	CAISSE CASE
1	0550 - ZC	ZINC	7 x 50	49 - 51	10 - 12	9.5-10.5	6.7 - 7.1	6.7 - 7	2,000
2	0551 - ZC	ZINC	7 x 50	49 - 51	10 - 12	9.5-10.5	6.7 - 7.1	6.7 - 7	2,000
2	0551 - NR	NOIR / BLACK	7 x 50	49 - 51	10 - 12	9.5-10.5	6.7 - 7.1	6.7 - 7	2,000
1	550Z - 6.3	ZINC	6.3 x 50	49 - 51	10 - 12	9.5-10.5	6 - 6.4	6.7 - 7	2,000

* AVEC TROU POUR RECEVOIR CAPUCHON DE PLASTIQUE
 * WITH HOLE TO RECEIVE PLASTIC CAP

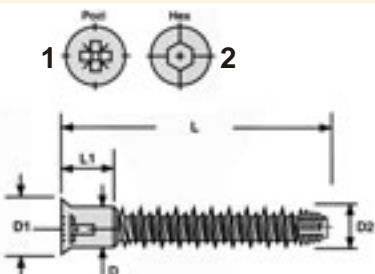

FILAGE "HI-LO" THREAD

1	550Z - HL 6.3	ZINC	6.3 x 50	49 - 51	10 - 12	9.5-10.5	6 - 6.4	6.7 - 7	2,000
2	551Z - HL	ZINC	7 x 50	49 - 51	10 - 12	9.5-10.5	6.7 - 7.1	6.7 - 7	2,000

* AVEC TROU POUR RECEVOIR CAPUCHON DE PLASTIQUE
 * WITH HOLE TO RECEIVE PLASTIC CAP

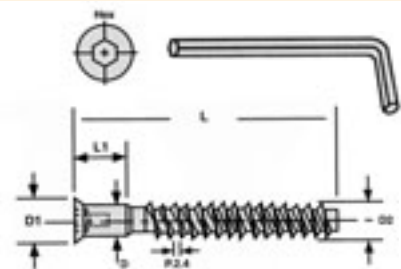

# QUINKO-TEK	COULEUR COLOR	DIM.	DESCRIPTION	CAISSE CASE
P551N - 08	NOIR / BLACK	7 x 50	8 vis avec une clé hexagonale 4mm 8 screws with one allen key 4mm	150
P551N - 12	NOIR / BLACK	7 x 50	12 vis avec une clé hexagonale 4mm 12 screws with one allen key 4mm	150

* AUTRE COMBINAISON DE PRODUITS DISPONIBLE SUR COMMANDE SPÉCIALE
 * OTHER PRODUCT COMBINATIONS AVAILABLE ON SPECIAL ORDER

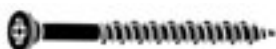

# QUINKO-TEK	COULEUR COLOR	DIMENSION	CAISSE CASE
518P - 33	NOIR / BLACK	HILO 4 x 33mm No. 8 pozi	5,000
518P - 45	NOIR / BLACK	HILO 4 x 45mm No. 8 pozi	4,000
518P - 50	NOIR / BLACK	HILO 4 x 50mm No. 8 pozi	4,000

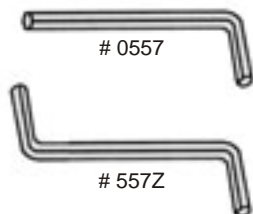

0557 - 04	NOIR / BLACK	M4 x 65 x 25mm	2,000
0557 - 05	NOIR / BLACK	M5 x 65 x 25mm	1,250
557Z - 04	ZINC	M4 x 20 x 50 x 20mm	2,000
557Z - 05	ZINC	M5 x 23 x 45 x 23mm	1,250



568A - NC	ZINC	1/4 - 20 x 10mm	7,000
568B - NC	ZINC	5/16 - 18 x 10mm	3,000

ATTACHES / FASTENERS

# QUINKO-TEK	COULEUR COLOR	DIMENSION	CAISSE CASE
593L - 20	LAITON / BRASS	1/4 - 20 x 20mm L	2,600
593L - 30	LAITON / BRASS	1/4 - 20 x 30mm L	2,000
593L - 40	LAITON / BRASS	1/4 - 20 x 40mm L	1,600
593L - 50	LAITON / BRASS	1/4 - 20 x 50mm L	1,400
593L - 60	LAITON / BRASS	1/4 - 20 x 60mm L	1,200
593L - 70	LAITON / BRASS	1/4 - 20 x 70mm L	1,000
593L - 80	LAITON / BRASS	1/4 - 20 x 80mm L	900
593L - 90	LAITON / BRASS	1/4 - 20 x 90mm L	600
593L - 110	LAITON / BRASS	1/4 - 20 x 110mm L	600
593N - 20	NICKEL	1/4 - 20 x 20mm L	2,600
593N - 30	NICKEL	1/4 - 20 x 30mm L	2,000
593N - 40	NICKEL	1/4 - 20 x 40mm L	1,600
593N - 50	NICKEL	1/4 - 20 x 50mm L	1,400
593N - 60	NICKEL	1/4 - 20 x 60mm L	1,200
593N - 70	NICKEL	1/4 - 20 x 70mm L	1,000
593N - 80	NICKEL	1/4 - 20 x 80mm L	900
593N - 90	NICKEL	1/4 - 20 x 90mm L	700
593N - 110	NICKEL	1/4 - 20 x 110mm L	600

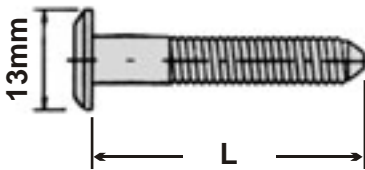

AUTRES DIMENSIONS ET FINITIONS DISPONIBLES SUR COMMANDE SPÉCIALE
OTHER SIZES AND FINISHES AVAILABLE ON SPECIAL ORDER

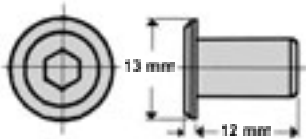

594N - 12	NICKEL	1/4 - 20 x 12mm L	3,000
594L - 12	LAITON / BRASS	1/4 - 20 x 12mm L	3,000



591D - 20	ZINC	1/4 - 20 x 20mm L	2,500
591D - 25	ZINC	1/4 - 20 x 25mm L	2,000
591Z - 13	ZINC	1/4 - 20 x 13mm L	5,000
590D - 25	ZINC	5/16 - 18 x 25mm L	2,500
590D - 8 - 32	ZINC	8/32 x 20mm L	5,000

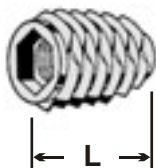

590E - 20	ZINC	5/16 - 18 x 20mm L	3,000
590E - 25	ZINC	5/16 - 18 x 25mm L	1,500
592E - 13	ZINC	1/4 - 20 x 13mm L	5,000
592E - 20	ZINC	1/4 - 20 x 20mm L	3,000
592Z - 13	ZINC	M6 x 13mm L	5,000

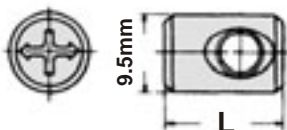

0567 - 13	ZINC	1/4 - 20 x 13mm L	5,000
567B - 20	ZINC	1/4 - 20 x 20mm L	2,000

GOUJONS, VIS, FIXATIONS / DOWELS, SCREWS, FASTENERS

GOUJON BOIS REGULIERS / WOOD DOWEL



# QUINKO-TEK	DIAM.	LONGUEUR LENGTH	CAISSE CASE
128W - 530	5mm	30mm	10,000
128W - 630	6mm	30mm	10,000
128W - 825	8mm	25mm	10,000
128W - 830	8mm	30mm	9,400
128W - 832	8mm	32mm	8,500
128W - 835	8mm	35mm	2,000
128W - 840	8mm	40mm	7,400

GOUJON BOIS ENCOLÉ / PRE-GLUED WOOD DOWEL



128WG - 7835	7.8mm	30mm	8,500
128WG - 830	8mm	30mm	7,000
128WG - 835	8mm	35mm	7,000

GOUJON EN PLASTIQUE / PLASTIC DOWEL



0128 - 535	5mm	35mm	10,000
0128 - 35	8mm	35mm	10,000
0128 - 27	8mm	27mm	10,000

RONDELLE DE FINITION / FINISHING CUP WASHER



# QUINKO-TEK	CAISSE CASE
566N - 06	1,000
566N - 08	1,000
566N - 10	1,000

GOUJON EN ACIER / DOWEL SCREW



559H - 3/16 x 2"	25
559H - 1/4 x 2"	25
559H - 1/4 x 2 - 1/2"	25
559H - 5/16 x 3"	25

BOULON DE PATTE DE TABLE / HANGER BOLT



559E - 1/4 x 2"	25
559E - 1/4 x 2 - 1/2"	25
559E - 1/4 x 3"	25
559E - 5/16 x 2 - 1/2"	25
559E - 5/16 x 3"	25
559E - 5/16 x 3 - 1/2"	25
559E - 5/16 x 4"	25

EUROSCREW / EUROSCREW



EURO - 9mm	6.3 X 9mm	5,000
EURO - 12mm	6.3 X 12mm	5,000
EURO - 16mm	6.3 X 16mm	5,000

VIS FIXATIONS SCREW FASTENERS

Série 560 Series

A Auto-fraiseuse / Nibs

C Combiné / Quadrex

B Standard / Standard

D Type 17 / Type 17

GRANDEUR / SIZE	COULEUR / COLOR	CAISSE CASE	A	B	C	D
4" x 5/8"	BR	20.000		✓		
5" x 1/2"	ZC	15.000		✓	✓	
5" x 5/8"	ZC	15.000		✓	✓	
6" x 5/8"	ZC	15.000		✓	✓	
6" x 1 - 1/4"	ZC	10.000	✓			
6" x 1 - 1/4"	PL	10.000	✓			
6" x 1 - 1/2"	ZC	7.500	✓			
6" x 1 - 1/2"	PL	7.500	✓			
6" x 1 - 3/4"	ZC	6.000	✓			
6" x 1 - 3/4"	PL	6.000	✓			
8" x 5/8"	ZC	12.000		✓	✓	
8" x 5/8"	PL	12.000		✓	✓	
8" x 3/4"	ZC	10.000		✓	✓	✓
8" x 3/4"	PL	10.000		✓	✓	✓
8" x 1"	ZC	10.000	✓	✓	✓	✓
8" x 1"	PL	10.000	✓	✓	✓	✓
8" x 1 - 1/8"	ZC	9.000	✓	✓	✓	
8" x 1 - 1/8"	PL	9.000	✓	✓	✓	
8" x 1 - 1/4"	ZC	7.500	✓	✓	✓	✓
8" x 1 - 1/4"	PL	7.500	✓	✓	✓	✓
8" x 1 - 1/2"	ZC	6.500	✓	✓	✓	✓
8" x 1 - 1/2"	PL	6.500	✓	✓	✓	✓
8" x 1 - 3/4"	ZC	5.000	✓	✓	✓	✓
8" x 1 - 3/4"	PL	5.000	✓	✓	✓	✓
8" x 2"	ZC	4.000	✓	✓	✓	✓
8" x 2"	PL	4.000	✓	✓	✓	✓
8" x 2 - 1/2"	ZC	3.000	✓	✓	✓	✓
8" x 2 - 1/2"	PL	3.000	✓	✓	✓	✓
8" x 3"	ZC	2.000	✓	✓	✓	✓
8" x 3"	PL	2.000	✓	✓	✓	✓

Série 564 Series

A Combiné / Quadrex

B Type 17 / Type 17

GRANDEUR / SIZE	COULEUR / COLOR	CAISSE CASE	A	B
6" x 5/8"	ZC	20.000	✓	
6" x 5/8"	PL	20.000	✓	
6" x 1"	ZC	13.000	✓	✓
6" x 1"	PL	13.000	✓	
8" x 1/2"	ZC	15.000	✓	✓
8" x 1/2"	PL	15.000	✓	
8" x 9/16"	ZC	15.000	✓	
8" x 9/16"	PL	15.000	✓	
8" x 5/8"	ZC	15.000	✓	
8" x 5/8"	PL	15.000	✓	

Série 564 Series

avec rondelles

with washers

A Combiné / Quadrex

B Type 17 / Type 17

GRANDEUR / SIZE	COULEUR / COLOR	CAISSE CASE	A	B
8" x 1"	ZC	9.000	✓	
8" x 1 - 1/8"	ZC	7.000	✓	
8" x 1 - 1/4"	ZC	6000	✓	
8" x 1 - 1/2"	ZC	5.000	✓	
8" x 1 - 3/4"	ZC	4.000	✓	
8" x 2"	ZC	3.500	✓	✓
8" x 2 - 1/2"	ZC	2.500	✓	✓
8" x 3"	ZC	2.000	✓	✓



Qualité **Robertson** disponible
sur commande spéciale /
Robertson quality available
upon special order

ZC = ZINC / ZINC ; PL = NATURE / PLAIN ; BR = LAITON / BRASS

**VIS FIXATIONS
SCREW FASTENERS**

Série Vis Machine / Machine Screw Series



A Tête ronde combinée /
Round Head Quadrex



B Tête plate combinée /
Flat Head Quadrex

Série 562 Series



A Vis " Truss " combinée /
" Truss " Combination Screw

GRANDEUR / SIZE	COULEUR / COLOR	CAISSE CASE	A	B	GRANDEUR / SIZE	COULEUR / COLOR	CAISSE CASE	A
1/4" - 20 x 3/8"	ZC	6.000	✓		8" - 32 x 1/4"	ZC	15.000	✓
1/4" - 20 x 1/2"	ZC	6.000	✓		8" - 32 x 5/16"	ZC	15.000	✓
1/4" - 20 x 5/8"	ZC	5.000	✓	✓	8" - 32 x 3/8"	ZC	15.000	✓
1/4" - 20 x 3/4"	ZC	5.000	✓	✓	8" - 32 x 1/2"	ZC	13.000	✓
1/4" - 20 x 1"	ZC	3.500	✓	✓	8" - 32 x 5/8"	ZC	12.000	✓
1/4" - 20 x 1 - 1/4"	ZC	3.000	✓	✓	8" - 32 x 3/4"	ZC	11.000	✓
1/4" - 20 x 1 - 1/2"	ZC	2.500	✓	✓	8" - 32 x 7/8"	ZC	8.000	✓
1/4" - 20 x 1 - 3/4"	ZC	2.000	✓	✓	8" - 32 x 15/16"	ZC	7.000	✓
1/4" - 20 x 2"	ZC	1.500	✓	✓	8" - 32 x 1"	ZC	5.500	✓
1/4" - 20 x 2 - 1/4"	ZC	1.400	✓	✓	8" - 32 x 1 - 1/8"	ZC	5.000	✓
1/4" - 20 x 2 - 1/2"	ZC	1.000	✓	✓	8" - 32 x 1 - 1/4"	ZC	5.000	✓
1/4" - 20 x 3"	ZC	1.000	✓	✓	8" - 32 x 1 - 3/8"	ZC	4.800	✓
5/16" - 18 x 3/4"	ZC	2.500	✓	✓	8" - 32 x 1 - 1/2"	ZC	4.000	✓
5/16" - 18 x 1"	ZC	2.000		✓	8" - 32 x 1 - 3/4"	ZC	3.500	✓
5/16" - 18 x 1 - 1/4"	ZC	1.700		✓	8" - 32 x 2"	ZC	3.000	✓
5/16" - 18 x 1 - 1/2"	ZC	1.500		✓	M4 X 21mm	ZC	10.000	✓
5/16" - 18 x 1 - 3/4"	ZC	1.200		✓	M4 X 22mm	ZC	10.000	✓
5/16" - 18 x 2"	ZC	1.000	✓	✓	M4 X 25mm	ZC	5.000	✓
5/16" - 18 x 2 - 1/2"	ZC	900		✓	M4 X 32mm	ZC	5.000	✓
5/16" - 18 x 3"	ZC	600	✓	✓	M4 X 35mm	ZC	5.000	✓
					M4 X 40mm	ZC	5.000	✓

**RONDELLES PLATES
FLAT WASHERS**



**ÉCROUS HEXAGONAUX
HEXAGONAL NUTS**



**ÉCROUS PAPILLONS
WING NUTS**



GRANDEUR / SIZE	COULEUR / COLOR	CAISSE CASE	GRANDEUR / SIZE	COULEUR / COLOR	CAISSE CASE	GRANDEUR / SIZE	COULEUR / COLOR	CAISSE CASE
1/4 3/16 9/16	ZC	15.000	1/14 - 20	ZC	5.000	1/14 - 20	ZC	5.000
5/16 1/4 3/4	ZC	9.000	5/16 - 18	ZC	3.000	5/16 - 18	ZC	3.000

I.D. B.S O.D

Autres modèles et grandeurs disponibles sur commande spéciale / Other models and sizes available upon special order

ÉQUERRES / BRACKETS

	# QUINKO-TEK	HAUTEUR HEIGHT	LARGEUR WIDTH	LONGUEUR LENGTH	FINI FINISH	MATERIEL MATERIAL	CAISSE CASE
	0202 - PL 0202 - BL	3/4" 3/4"	3/4" 3/4"	3/4" 3/4"	ACIER / PLAIN BLANC / WHITE	ACIER / STEEL ACIER / STEEL 18 G.	5,000 5,000
	202D - PL	3/4"	3/4"	1 1/2"	ACIER / PLAIN	ACIER / STEEL 18 G.	2,000
	202L - PL	3/4"	3/4"	2 1/2"	ACIER / PLAIN	ACIER / STEEL 20 G.	1,000
	0204 - PL	3/4"	3/4"	6"	ACIER / PLAIN	ACIER / STEEL 20 G.	500
	0203 - PL 0203 - BL	1" 1"	1" 1"	1 3/4" 1 3/4"	ACIER / PLAIN BLANC / WHITE	ACIER / STEEL ACIER / STEEL 18 G.	1,000 1,000
	202P - 45	3/4"	3/4"	3/4"	ACIER / PLAIN	ACIER / STEEL 18 G.	5,000
	0211 - PL	-	3/4"	2"	ACIER / PLAIN	ACIER / STEEL 18 G.	5,000

ÉQUERRES / BRACKETS

# QUINKO-TEK	HAUTEUR HEIGHT	LARGEUR WIDTH	LONGUEUR LENGTH	FINI FINISH	MATERIEL MATERIAL	CAISSE CASE
						
211D - PL	-	1"	2"	ACIER / STEEL	ACIER / STEEL	1,000
211D - NR	-	1"	2"	NOIR / BLACK	ACIER / STEEL	1,000
						
0210 - 38	20mm	20mm	38mm	BLANC / WHITE	PLAST.	500
						
203K - BL	3/4"	1/2"	2"	BLANC / WHITE	PLAST.	50
203KK - BL	3/4"	1/2"	2"	BLANC / WHITE	PLAST.	500

FERRURES D'ASSEMBLAGE / ASSEMBLY FITTINGS

# QUINKO-TEK	COULEUR COLOR	MATERIEL MATERIAL	DESCRIPTION	CAISSE CASE
				
0558 - BL	BLANC / WHITE	NYLON	FERRURE D'ASSEMBLAGE À VISSER	1,000
0558 - NR	BLANC / WHITE	NYLON	SCREW-ON K.D. FITTING	1,000
				
558D - BL	BLANC / WHITE	NYLON	FERRURE D'ASSEMBLAGE À GOUJONS	1,000
			KNOCK IN K.D. FITTING	
			GOUJONS / DOWELS : 10mm	
				
0555 - BL	BLANC / WHITE CHROME	NYLON METAL	FERRURE D'ASSEMBLAGE À VISSER	1,000
			SCREW-ON K.D. FITTING	
				
509B - 00	NAT. / NATURAL	BOIS / WOOD	BISCUIT LAMELO / BISCUIT # 00	1,000
509B - 10	NAT. / NATURAL	BOIS / WOOD	BISCUIT LAMELO / BISCUIT # 10	1,000
509B - 20	NAT. / NATURAL	BOIS / WOOD	BISCUIT LAMELO / BISCUIT # 20	1,000

EQUERRES / BRACKETS

# QUINKO-TEK	HAUTEUR HEIGHT	LARGEUR WIDTH	LONGUEUR LENGTH	FINIS FINISH	MATERIEL MATERIAL	CAISSE CASE
	200P - B 3/4	3/4"	3/4"	3/4"	BLANC / WHITE	1,000
	200P - N 3/4	3/4"	3/4"	3/4"	NOIR / BLACK	1,000
	200P - B2	3/4"	3/4"	2"	BLANC / WHITE	1,000
	200P - N2	3/4"	3/4"	2"	NOIR / BLACK	1,000
	200P - B 3 1/2	3/4"	3/4"	3 - 1/2"	BLANC / WHITE	1,000
	200P - N 3 1/2	3/4"	3/4"	3 - 1/2"	NOIR / BLACK	1,000
	200P - B 6	3/4"	3/4"	6"	BLANC / WHITE	1,000
	200P - N 6	3/4"	3/4"	6"	NOIR / BLACK	1,000
	200P - B 9 1/2	3/4"	3/4"	9 - 1/2"	BLANC / WHITE	1,000
	200P - N 9 1/2	3/4"	3/4"	9 - 1/2"	NOIR / BLACK	1,000
	200P - B 12	3/4"	3/4"	12"	BLANC / WHITE	1,000
	200P - N 12	3/4"	3/4"	12"	NOIR / BLACK	1,000
	212L - 1 1/2	1 - 1/2"	3/8"	1 - 1/2"	ZINC / ZINC	100
	212L - 2	2"	3/8"	2"		100
	212L - 2 1/2	2 - 1/2"	1/2"	2 - 1/2"		100
	212L - 3 1/2	3 1/2"	5/8"	3 1/2"		100
	212L - 5	5"	7/8"	5"		100
	212L - 6	6"	1"	6"		100
	211Z - 2		5/8"	2"	ZINC / ZINC	100
	211Z - 2 1/2		5/8"	2 - 1/2"		100
	211Z - 4		7/8"	4"		100
	211Z - 5		1"	5"		100
	211Z - 6		1 - 1/8"	6"		100
	211MZ - 230	3mm	20mm	230mm	ZINC / ZINC	100
	211PB - 102	3mm	18mm	102mm	BLANC / WHITE	100
	200P - BL	20mm	10mm	-	BLANC / WHITE	100
	200P - NR	20mm	10mm	-	NOIR / BLACK	100

FERRURES D'ASSEMBLAGE / ASSEMBLY FITTINGS

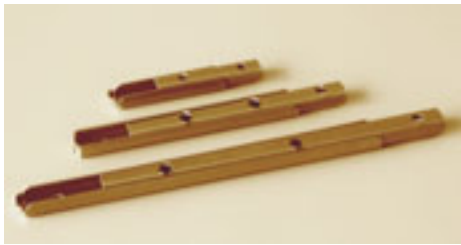

# QUINKO-TEK	DESCRIPTION	CAISSE CASE
244P - 2	Ferrures d'assemblage acier naturel 2" / 4" / 6"	100
244P - 4	Assembly fitting steel 2" / 4" / 6"	100
244P - 6		100
244Z - 42	Modèle simple 14x42mm Single model 14x42mm	100
244Z - 75	Modèle double 14x75mm Double model 14x75mm	100
	Ferrures assemblage - Zinc Keyhole Fitting - Zinc	
0216 - ZC	Serre joint comptoir Zinc - 1/4-20x85mm Counter-top joiner Zinc - 1/4-20x85mm	1,000
112B - 1 1/4	BLANC / WHITE	1,000
112N - 1 1/4	NOIR / BLACK	1,000
	Vis assemblage nylon 1 - 1/4" Assembly plastic screws 1 - 1/4"	
112B - 1 1/2	BLANC / WHITE	1,000
112N - 1 1/2	NOIR / BLACK	1,000
	Vis assemblage nylon 1 - 1/2" Assembly plastic screws 1 - 1/2"	
208P - BL	BLANC / WHITE	1,000
	Equerres de coins plastiques 80x40mm Plastic corner braces 80x40mm	
0463 - ZC	ZINC / ZINC	1
	Connecteur de tables en acier Table connector	

FastCap

**CACHE VIS AUTOCOLLANTS EN PVC
SELF-STICK PVC SCREW COVERS**



#	# QUINKO-TEK	DIAM.	CAISSE CASE
1	549BL - PC	9/16" 14mm	1040
2	549BA - PC	9/16" 14mm	1040
3	549AM - PC	9/16" 14mm	1040
4	549NR - PC	9/16" 14mm	1040
5	549GN - PC	9/16" 14mm	1040
6	549GF - PC	9/16" 14mm	1040
7	549CES - PC	9/16" 14mm	1040
8	549CH - PC	9/16" 14mm	1040
9	549CA - PC	9/16" 14mm	1040
10	549CN - PC	9/16" 14mm	1040
11	549CD - PC	9/16" 14mm	1040
12	549CR - PC	9/16" 14mm	1040

#	# QUINKO-TEK	DIAM.	CAISSE CASE
13	549CHD - PC	9/16" 14mm	1040
14	549CRO - PC	9/16" 14mm	1040
15	549CM - PC	9/16" 14mm	1040
16	549AT - PC	9/16" 14mm	1040
17	549NP - PC	9/16" 14mm	1040
18	549NT - PC	9/16" 14mm	1040
19	549CC - PC	9/16" 14mm	1040
20	549EH - PC	9/16" 14mm	1040
21	549EM - PC	9/16" 14mm	1040
22	549ELB - PC	9/16" 14mm	1040
23	549EC - PC	9/16" 14mm	1040
24	549ERN - PC	9/16" 14mm	1040

#	# QUINKO-TEK	DIAM.	CAISSE CASE
25	549CF - PC	9/16" 14mm	1040
26	549AJ - PC	9/16" 14mm	1040
27	549AS - PC	9/16" 14mm	1040
28	549EA - PC	9/16" 14mm	1040
29	549CEN - PC	9/16" 14mm	1040
30	549CS - PC	9/16" 14mm	1040
31	549CEM - PC	9/16" 14mm	1040
32	549CB - PC	9/16" 14mm	1040
33	549CED - PC	9/16" 14mm	1040
34	549ASN - PC	9/16" 14mm	1040
35	549PN - PC	9/16" 14mm	1040
36	549HE - PC	9/16" 14mm	1040

FastCap

**CACHE VIS AUTOCOLLANTS EN BOIS NATUREL
SELF-STICK WOOD VENEER SCREW COVERS**



#	# QUINKO-TEK	DIAM.	CAISSE CASE
1	549CN - BN	9/16" 14mm	1040
2	549CB - BN	9/16" 14mm	1040
3	549EN - BN	9/16" 14mm	1040
4	549CE - BN	9/16" 14mm	1040
5	549AJ - BN	9/16" 14mm	1040
6	549PI - BN	9/16" 14mm	1040
7	549HI - BN	9/16" 14mm	1040
8	549SA - BN	9/16" 14mm	1040

#	# QUINKO-TEK	DIAM.	CAISSE CASE
9	549PA - BN	9/16" 14mm	1040
10	549BB - BN	9/16" 14mm	1040
11	549BN - BN	9/16" 14mm	1040
12	549NO - BN	9/16" 14mm	1040
13	549VG - BN	9/16" 14mm	1040
14	549AN - BN	9/16" 14mm	1040
15	549CEN - BN	9/16" 14mm	1040
16	549TE - BN	9/16" 14mm	1040

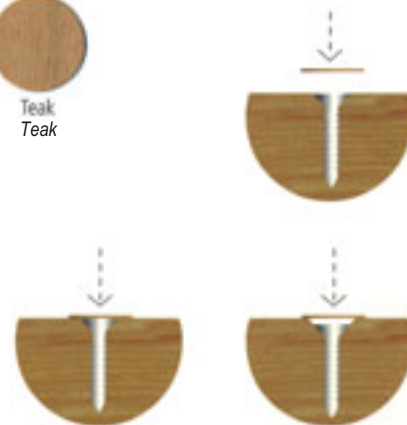

CACHE VIS / SCREW COVERS

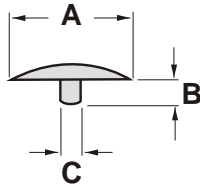

#	# QUINKO-TEK	COULEUR COLOR	MATERIEL MATERIAL	A	B	C	CAISSE CASE
1	0549 - AM	AMANDE / ALMOND	PLAST.	12mm	3mm	3mm	10,000
1	0549 - BL	BLANC / WHITE	PLAST.	12mm	3mm	3mm	10,000
1	0549 - BR	BRUN / BROWN	PLAST.	12mm	3mm	3mm	10,000
1	0549 - CN	CHÊNE / OAK	PLAST.	12mm	3mm	3mm	10,000
1	0549 - GR	GRIS / GREY	PLAST.	12mm	3mm	3mm	10,000
1	0549 - NR	NOIR / BLACK	PLAST.	12mm	3mm	3mm	10,000
2	0549 - 06	BLANC / WHITE	PLAST.	15mm	3mm	2.41mm	10,000
3	0552 - BL	BLANC / WHITE	PLAST.	12mm	5mm	3mm	10,000
3	0552 - NR	NOIR / BLACK	PLAST.	12mm	5mm	3mm	10,000
3	0552L - BL	BLANC / WHITE	PLAST.	15mm	5mm	3mm	10,000
3	0552L - NR	NOIR / BLACK	PLAST.	15mm	5mm	3mm	10,000
3	0552L - BS	CHÊNE / OAK	PLAST.	15mm	5mm	3mm	10,000

1 ADAPTABLE AVEC VIS # 8 / COMPATIBLE WITH # 8 SCREWS

2 ADAPTABLE AVEC VIS # 6 / COMPATIBLE WITH # 6 SCREWS

3 ADAPTABLE AVEC VIS CONFIRMAT / COMPATIBLE WITH CONFIRMAT SCREWS

* AUTRES COULEURS DISPONIBLES SUR COMMANDE / OTHER COLORS AVAILABLE ON ORDER

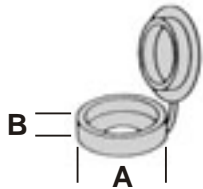

# QUINKO-TEK	COULEUR COLOR	MATERIEL MATERIAL	A	B	C	CAISSE CASE
0548 - AM	AMANDE / ALMOND	PLAST.	14mm	7.5mm	-	10,000
0548 - BL	BLANC / WHITE	PLAST.	14mm	7.5mm	-	10,000
0548 - GR	GRIS / GREY	PLAST.	14mm	7.5mm	-	10,000
0548 - NR	NOIR / BLACK	PLAST.	14mm	7.5mm	-	10,000

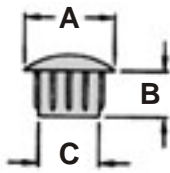

0114 - AM	AMANDE / ALMOND	PLAST.	12mm	6mm	10mm	10,000
0114 - BL	BLANC / WHITE	PLAST.	12mm	6mm	10mm	10,000
0114 - BR	BRUN / BROWN	PLAST.	12mm	6mm	10mm	10,000
0114 - GR	GRIS / GREY	PLAST.	12mm	6mm	10mm	10,000
0114 - NR	NOIR / BLACK	PLAST.	12mm	6mm	10mm	10,000
0114 - CN	CHÊNE / OAK	PLAST.	12mm	6mm	10mm	10,000
114L - BL	BLANC / WHITE	PLAST.	12mm	3mm	10mm	10,000
114L - NR	NOIR / BLACK	PLAST.	12mm	3mm	10mm	10,000

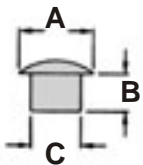

114B - 08	BLANC / WHITE	PLAST.	12mm	6mm	8mm	10,000
114N - 08	NOIR / BLACK	PLAST.	12mm	6mm	8mm	10,000
114B - 12	BLANC / WHITE	PLAST.	15mm	6mm	12mm	10,000
114N - 12	NOIR / BLACK	PLAST.	15mm	6mm	12mm	10,000

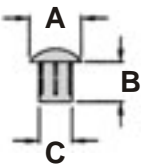

114B - 05	BLANC / WHITE	PLAST.	8mm	6mm	5mm	10,000
114N - 05	NOIR / BLACK	PLAST.	8mm	6mm	5mm	10,000

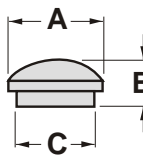

547M - 3/8	MERISIER / BIRCH	BOIS / WOOD	13.5mm	9mm	10mm	10,000
547M - 1/2	MERISIER / BIRCH	BOIS / WOOD	16mm	9mm	13mm	10,000
547C - 3/8	CHÊNE / OAK	BOIS / WOOD	13.5mm	9mm	10mm	10,000
547C - 1/2	CHÊNE / OAK	BOIS / WOOD	16mm	9mm	13mm	10,000

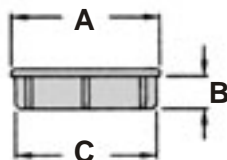

114B - 35	BLANC / WHITE	PLAST.	37mm	8mm	35mm	10,000
114N - 35	NOIR / BLACK	PLAST.	37mm	8mm	35mm	10,000
114BR - 35	BRUN / BROWN	PLAST.	37mm	8mm	35mm	10,000

**CAPUCHONS ET VIS DÉCORATIVES
DECORATIVE COVER CAPS AND SCREWS**



# QUINKO-TEK	DIMENSION	COULEUR COLOR	CAISE CASE
548LT - 15	15mm	LAITON / BRASS	100
548CH - 15	15mm	CHROME	100
548LT - 15	15mm	LAITON BROSSÉ / BRUSH BRASS	100
548CS - 15	15mm	CHROME BROSSÉ / BRUSH CHROME	100
548LT - 25	25mm	LAITON / BRASS	100
548CH - 25	25mm	CHROME	100
548LS - 25	25mm	LAITON BROSSÉ / BRUSH BRASS	100
548CS - 25	25mm	CHROM BROSSÉ / BRUSH CHROME	100

Rondelles de finition / Decorative screw caps



560BP - 3/4	3/4"	ACIER NATUREL / PLAIN STEEL	100
560BP - 1	1"		100
560BP - 1 1/4	1-1/4"		100
560BP - 1 1/2	1-1/2"		100
560BP - 1 3/4	1-3/4"		100
560BP - 2	2"		100
560BP - 2 1/2	2-1/2"		100
560BP - 3	3"		100

Vis a bois / Wood Screws



560MP - 1	1"	ACIER NATUREL / PLAIN STEEL	100
560MP - 1 1/4	1-1/4"		100
560MP - 1 1/2	1-1/2"		100
560MP - 2	2"		100

Vis filets 1/4 - 20 / 1/4 - 20 Thread screws

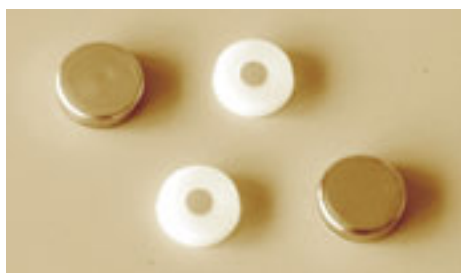



548LT - IN	5/8"	LAITON / BRASS	1,000
548CH - IN	5/8"	CHROME / CHROME	1,000

Cache-vis décoratifs SNAP-CAPS / SNAP-CAPS screw covers



Shemoui
ÉCLAIRAGE / LIGHTING

# QUINKO-TEK	COULEUR COLOR	INTERRUPTEUR ON/OFF SWITCH	LONG. DE FIL CORD LENGTH	AMPOULE BULB	DIAM. x HAUT. / HEIGHT	PERÇAGE DRILLING	
	BRUN BROWN	OUI / YES	6'	15 watt	-	-	
	BRUN BROWN	OUI / YES	6'	15 watt	-	-	
	0921 - BL	BLANC WHITE	OUI / YES	6'	25 watt	110mm x 90mm	83mm
	0921 - CH	CHROME	OUI / YES	6'	25 watt	110mm x 90mm	83mm
	0921 - NR	NOIR BLACK	OUI / YES	6'	25 watt	110mm x 90mm	83mm
	0921 - LT	LAITON BRASS	OUI / YES	6'	25 watt	110mm x 90mm	83mm
	0922 - BL	BLANC WHITE	OUI / YES	6'	25 watt	110mm x 90mm	83mm
	0922 - CH	CHROME	OUI / YES	6'	25 watt	110mm x 90mm	83mm
	0922 - NR	NOIR BLACK	OUI / YES	6'	25 watt	110mm x 90mm	83mm
	0922 - LT	LAITON BRASS	OUI / YES	6'	25 watt	110mm x 90mm	83mm

Shemoi
ÉCLAIRAGE / LIGHTING

# QUINKO-TEK	COULEUR COLOR	INTERRUPTEUR ON/OFF SWITCH	LONG. DE FIL CORD LENGTH	AMPOULE BULB	DIAM. x HAUT. / HEIGHT	PERÇAGE DRILLING
	0923 - BL	BLANC WHITE	OUI / YES	6'	25 watt	110mm x 90mm 83mm
	0923 - CH	CHROME	OUI / YES	6'	25 watt	110mm x 90mm 83mm
	0923 - NR	NOIR BLACK	OUI / YES	6'	25 watt	110mm x 90mm 83mm
	0923 - LT	LAITON BRASS	OUI / YES	6'	25 watt	110mm x 90mm 83mm
	0929 - BL	BLANC WHITE	OUI / YES	10'	40 watt	83mm x 90mm 85mm
	0929 - CH	CHROME	OUI / YES	10'	40 watt	83mm x 90mm 85mm
	0929 - NR	NOIR BLACK	OUI / YES	10'	40 watt	83mm x 90mm 85mm
	0929 - LT	LAITON BRASS	OUI / YES	10'	40 watt	83mm x 90mm 85mm
	911F - 15	BLANC WHITE	OUI / YES	6'	8 watt	LONG. 15" LGT. -
	911F - 21	BLANC WHITE	OUI / YES	6'	15 watt	LONG. 21" LGT. -
	911F - 27	BLANC WHITE	OUI / YES	6'	20 watt	LONG. 27" LGT. -
	930H - BL	BLANC WHITE	NON / NO	M = 6' F = 1'	PAR 20 50 watt	110mm x 90mm 83mm
	930H - CH	CHROME	NON / NO	M = 6' F = 1'	PAR 20 50 watt	110mm x 90mm 83mm
	930H - NR	NOIR BLACK	NON / NO	M = 6' F = 1'	PAR 20 50 watt	110mm x 90mm 83mm
	930H - LT	LAITON BRASS	NON / NO	M = 6' F = 1'	PAR 20 50 watt	110mm x 90mm 83mm
	930H - CS	CH. SATINÉ SATIN CH.	NON / NO	M = 6' F = 1'	PAR 20 50 watt	110mm x 90mm 83mm

Shemoi
ÉCLAIRAGE / LIGHTING

# QUINKO-TEK	COULEUR COLOR	INTERRUPTEUR ON/OFF SWITCH	LONG. DE FIL CORD LENGTH	AMPOULE BULB	DIAM. x HAUT. / HEIGHT	PERÇAGE DRILLING
901R - BL	BLANC WHITE	OUI / YES	6'	HALO. 20 watt	65mm x 22mm	60mm
901R - CH	CHROME	OUI / YES	6'	HALO. 20 watt	65mm x 22mm	60mm
901R - NR	NOIR BLACK	OUI / YES	6'	HALO. 20 watt	65mm x 22mm	60mm
901R - LT	LAITON BRASS	OUI / YES	6'	HALO. 20 watt	65mm x 22mm	60mm

TOUTES LES LUMIÈRES HALOGÈNES SONT DISPONIBLES EN INVENTAIRE EN ENSEMBLE DE DEUX OU TROIS LUMIÈRES SUR UN TRANSFORMATEUR

ALL HALOGEN LIGHTS ARE AVAILABLE FROM STOCK IN KITS OF 2 OR 3 LIGHTS ON ONE TRANSFORMER



902R - BL	BLANC WHITE	OUI / YES	6'	HALOG. 20 watt	102mm x 60mm	90mm
902R - CH	CHROME	OUI / YES	6'	HALOG. 20 watt	102mm x 60mm	90mm
902R - NR	NOIR BLACK	OUI / YES OUI / YES	6'	HALOG. 20 watt	102mm x 60mm	90mm
902R - LT	LAITON BRASS	OUI / YES	6'	HALOG. 20 watt	102mm x 60mm	90mm
905R - BL	BLANC WHITE	OUI / YES	6'	HALOG. 50 watt	102mm x 60mm	90mm
905R - CH	CHROME	OUI / YES	6'	HALOG. 50 watt	102mm x 60mm	90mm
905R - NR	NOIR BLACK	OUI / YES	6'	HALOG. 50 watt	102mm x 60mm	90mm
905R - LT	LAITON BRASS	OUI / YES	6'	HALOG. 50 watt	102mm x 60mm	90mm



904R - BL	BLANC WHITE	OUI / YES	10'	HALOG. 50 watt	205mm x 100mm x 30mm	-
-----------	----------------	-----------	-----	-------------------	-------------------------	---





900D - BL	BLANC WHITE	OUI / YES	10'	HALOG. 40 watt	467mm x 90mm x 43mm	-
-----------	----------------	-----------	-----	-------------------	------------------------	---

Shemoui

ÉCLAIRAGE / LIGHTING

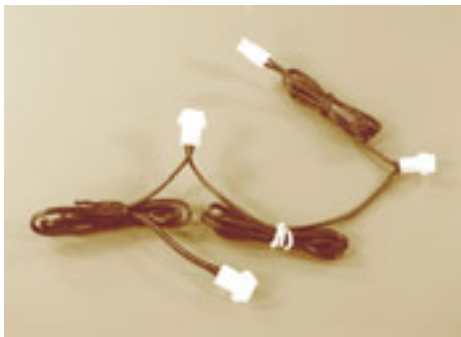

# QUINKO-TEK	COULEUR COLOR	INTERRUPTEUR ON/OFF SWITCH	LONG. DE FIL CORD LENGTH	DESCRIPTION
	0918 - PB BLANC WHITE	OUI / YES	10'	BARRE D'ALIMENTATION 6 PRISES POWER BAR 6 OUTLETS
	918PB - 3T NOIR BLACK	NON / NO	10'	BARRE D'ALIMENTATION 3 PRISES AVEC PRISE TÉLÉPHONE POWER BAR 3 OUTLETS WITH PHONE CONNECTION
	TD 620 BRUN BROWN	OUI / YES	M = 10' F = 2'	INTERRUPTEUR AU TOUCHÉ TOUCH DIMMER SWITCH
	EXTEN-HALL	-	6'	EXTENSION POUR HALOGENE SIMPLE SIMPLE EXTENSION FOR HALOGENE
	EXTEN-HAL2	-	M = 4' 2F = 2'	EXTENSION POUR HALOGENE DOUBLE DOUBLE EXTENSION FOR HALOGENE
	EXTEN-HAL3	-	M = 2' 3F = 2'	EXTENSION POUR HALOGENE TRIPLE TRIPLE EXTENSION FOR HALOGENE
	# QUINKO-TEK	DESCRIPTION		
OAMP - T1	AMPOULES DE REMPLACEMENT POUR 901R / 900D REPLACEMENT BULBS FOR 901R / 900D			
OAMP - T2	AMPOULES DE REMPLACEMENT POUR 902R REPLACEMENT BULBS FOR 902R			
OAMP - T5	AMPOULES DE REMPLACEMENT POUR 905R / 904R REPLACEMENT BULBS FOR 905R / 904R			
0929 - 50	AMPOULES DE REMPLACEMENT POUR 930H REPLACEMENT BULBS FOR 930H			
0913 - AP	AMPOULES DE REMPLACEMENT POUR 0914 / 915 REPLACEMENT BULBS FOR 0914 / 915			
0929 - 40	AMPOULES DE REMPLACEMENT POUR 0921 / 0922 / 0923 REPLACEMENT BULBS FOR 0921 / 0922 / 0923			

Shemoi
ÉCLAIRAGE / LIGHTING

# QUINKO-TEK	COULEUR COLOR	FIL / CORD	WATTS	DIAM. TUBE (ø) / TUBE DIAM. (ø)	LONGUEUR LENGTH
0922 - BL	BLANC / WHITE	10'	8	1/2" (12.7 mm)	83mm
0922 - CH	BLANC / WHITE	10'	13	1/2" (12.7 mm)	83mm
0922 - NR	BLANC / WHITE	10'	21	1/2" (12.7 mm)	83mm
0922 - LT	BLANC / WHITE	10'	28	1/2" (12.7 mm)	83mm

Lumière SLIMFIVE / SLIMFIVE light

917F-8W	BLANC / WHITE	10'	8	1/2" (12.7 mm)	273mm
917F-13W	BLANC / WHITE	10'	13	1/2" (12.7 mm)	394mm
917F-21W	BLANC / WHITE	10'	21	1/2" (12.7 mm)	521mm
917F-28W	BLANC / WHITE	10'	28	1/2" (12.7 mm)	624mm

Lumière THINFOUR / THINFOUR light

916F-8W	BLANC / WHITE	10'	8		15 1/2" (394mm)
916F-13W	BLANC / WHITE	10'	12		19 1/2" (495mm)
916F-21W	BLANC / WHITE	10'	16		21 1/2" (540mm)
916F-28W	BLANC / WHITE	10'	20		23 1/2" (585mm)
916F-28W	BLANC / WHITE	10'	22		29 (737mm)
916F-28W	BLANC / WHITE	10'	24		34 1/2" (877mm)
916F-28W	BLANC / WHITE	10'	28		46 1/4" (1175mm)

Lumière THINFOUR / THINFOUR light

0931-50W	BLANC / WHITE	10'	50	???	355
----------	---------------	-----	----	-----	-----

0931-50W Lampe halogène extensible de 14" (355 mm) à 26" (660 mm). Protection contre les hautes tensions et les court-circuits.
 Halogen display light expandable from 14" (355 mm) to 26" (660 mm). Overload and short-circuit protection.



0931-6W	BLANC / WHITE	10'	6	1 3/4" (44mm)	12 1/2" (318mm)
0931-8W	BLANC / WHITE	10'	8	1 3/4" (44mm)	14 1/2" (368mm)
0931-13W	BLANC / WHITE	10'	13	1 3/4" (44mm)	24 1/2" (922mm)

Baguette de lumière **ULTRA MINCE**. Ampoule fluorescente prête à enficher. Allumage instantané sans effet stroboscopique. Montage pivotant. Durée de l'ampoule jusqu'à 7 500 heures.
ULTRA SLIM light stick. Ready to plug fluorescent bulb. Instant flicker-free turning on. Pivot mounting. Duration of bulb of up to 7 5000 hours.



0932 - CH	CHROME	10'	6	???	???
-----------	--------	-----	---	-----	-----

Lampe de bureau moderne. Pivote à 180°. Hauteur et position ajustables. Adaptateur de style balast. Fournie avec prise et câble RJ45 pour accès Internet à haute vitesse. Efficace en énergie.
 Modern desk lamp. Rotates 180°. Adjustable height and position. Adapter style balast Energy efficient.

Shemoui

ÉCLAIRAGE / LIGHTING



# QUINKO-TEK	COULEUR / COLOR	FIL / CORD	WATTS	AMPOULE / BULB	LONGUEUR / LENGTH
0935 - BL	BLANC / WHITE	10'	10, 20	HALOGÈNE /	18"
0935 - NR	NOIR / BLACK	10'	10, 20	HALOGEN	18"



Jeu de lampes mini-rail comprenant : mini-rail (18" / 460 mm), transformateur enfichable avec interrupteur marche / arrêt, 2 têtes flexibles, 2 ampoules halogènes 20W enrobées de verre.
En option : Longueur additionnelle de mini-rail (18" / 460 mm), bouchons d'extrémité, têtes flexibles additionnelles, MR11 10 W, 20 W
Mini-track light kit including : 18" / 460 mm mini-track, plug-in transformer with in-line switch, 2 flexible heads, 2 MR11 glass covered 20W halogen bulbs - Optional : additional 18" / 460 mm mini-track, end caps, flexible heads, MR11 10 W, 20 W

936/2-AJ2	BLANC / WHITE	10'	200	HALOGÈNE /	> 7' (2m)
936/2-AJ8	NOIR / BLACK	10'	200	HALOGEN	> 7' (2m)



Système ajustable de lumières halogènes 12 V sur rail : jusqu'à 7 pi (2 m) de rail, petits embouts têtes de rail, transformateur télécommandé, max. 200 W, montage sans outils, accessoires disponibles
Adjustable 12 V halogen track light system : Up to 7 ft long track (2 m), small track light heads, remote transformer, max. 200 W, no-tool mounting, many accessories available

# QUINKO-TEK	COULEUR / COLOR	FIL / CORD	WATTS	PRISES / OUTLETS	CARACTÉRISTIQUES / FEATURES
(A) 0918-PTF	BLANC / WHITE	10'	-	6	Protection RJ11
(B) 0918 - PB	BLANC / WHITE	10'	-	6	Adaptateur / Adaptor



Barre d'alimentation avec protection pour circuits électrique, de téléphone / modem et télécopieur
Surge with electrical, phone / modem and fax protection

918PB-3T	NOIR / BLACK	10'	-	3	inclut / includes : A
918PB-3TF	NOIR / BLACK	10'	-	3	inclut / includes : A, F
918PB-4FT	NOIR / BLACK	10'	-	3	inclut / includes : A, F



Barre de protection pour téléphone / modem et réseau : **A** = câble RJ11 (téléphone), **B** = fil de 10 pi, **C** = prise plate, **D** = entrée pour câble RJ45, **E** = entrée pour câble RJ11, **F** = câble RJ45 (réseau).
Tous les modèles incluent l'interrupteur, la protection contre les hautes tensions et montage facile.
Power harness for telephone / modem and network : **A** = RJ11 cable (telephone), **B** = 10' cord, **C** = flat plug, **D** = RJ45 wire jack, **E** = RJ11 wire jack, **F** = RJ45 cable (network).
All models include the combo switch / circuit breaker, surge protection and easy mounting.

918PB-MT	NOIR / BLACK	10'	-	5	-
----------	--------------	-----	---	---	---



Barre de protection pour téléphone / modem et réseau, incluant câble RJ11 (téléphone), fil de 10 pi, prise plate, entrée pour câbles RJ45 et RJ11, câbles RJ11 et RJ45 et entrée pour hub.
Ce modèle inclut l'interrupteur, la protection contre les hautes tensions et montage facile.
Power harness for telephone / modem and network, including RJ11 cable (telephone), **B** = 10' cord, **C** = flat plug, **D** = RJ45 wire jack, **E** = RJ11 wire jack, **F** = RJ45 cable (network).
This model includes the combo switch / circuit breaker, surge protection and easy mounting.

918PB-2C	NOIR / BLACK	10'	-	2	
918PB-3C	NOIR / BLACK	10'	-	3	

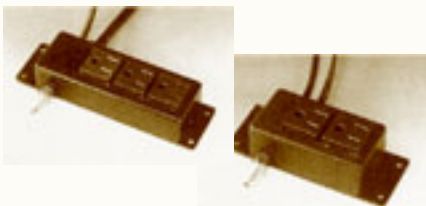

Barre de protection de plastique moulu rigide avec fil de 10' (disponible aussi en couleur amande)
Power harness made of high impact molded plastic with 10' cord (also available in almond)

**MOULURES EN PLASTIQUE
PLASTIC MOLDINGS**



# QUINKO-TEK	COULEUR COLOR	DIMENSION	ROULEAU ROLL
0149 - BL	BLANC / WHITE	3/4"	750'
0149 - NR	NOIR / BLACK	3/4"	750'
0149 - GR	GRIS / GRAY	3/4"	750'

Moulure en T avec insertion
T - Edge molding



149N - 1-1/8	NOIR / BLACK	1-1/8"	400'
--------------	--------------	--------	------

Moulure en T avec insertion
T - Edge molding



149N - 1-1/4	NOIR / BLACK	1-1/4"	400'
--------------	--------------	--------	------

Moulure en T avec insertion
T - Edge molding



149BN - N1-1/4	NOIR / BLACK	1-1/4"	200'
----------------	--------------	--------	------

Moulure en T avec insertion de type BULL - NOSE
T - Edge molding, BULL NOSE Model

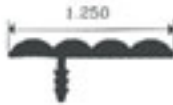

149LS - B1-1/4	BLANC / WHITE	1-1/4"	200'
----------------	---------------	--------	------

Moulure en T avec insertion pour contour Lazy-Suzan
Lazy-Suzan T - Edge molding

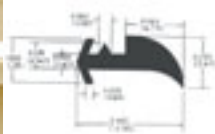

0155 - CL	CLAIR / CLEAR		1,500'
0155 - BL	BLANC / WHITE		1,500'
0155 - BR	BRUN / BROWN		1,500'
0155 - NR	NOIR / BLACK		1,500'
155X - CL	CLAIR / CLEAR (mini)		1,500'

Moulure à vitre
Glass door molding



0158 - NR	NOIR / BLACK	1/2"	100'
0159 - NR	NOIR / BLACK	5/8"	100'
0157 - NR	NOIR / BLACK	7/16"	100'

Moulure pour filières
File molding

**MOULURES EN PLASTIQUE
PLASTIC MOLDINGS**

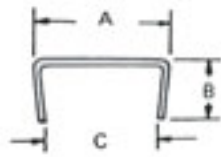

# QUINKO-TEK	COULEUR COLOR	DIMENSION	CAISSE CASE
0165 - BL	BLANC / WHITE	5/8"	100
0165 - NR	NOIR / BLACK	5/8"	100
0165 - GR	GRIS / GRAY	5/8"	100

Moulure en U
U molding



164B - 1/8	BLANC / WHITE	1/8" (A)	25
163B - 1/8		1/8" (B)	25
164B - 1/4		1/4" (A)	25
163B - 1/4		1/4" (B)	25
164B - 5/8		5/8" (A)	25
163B - 5/8		5/8" (B)	25
164B - 3/4		3/4" (A)	25
163B - 3/4		3/4" (B)	25

Voie de glissement garde manger, (A) haut, (B) bas
Plastic track for sliding door, (A) top, (B) bottom



166D - BL	BLANC / WHITE	DROIT / RIGHT	500
166B - BL	BLANC / WHITE	GAUCHE / LEFT	500

Coins pour moulure garde manger
Corners for shelf molding

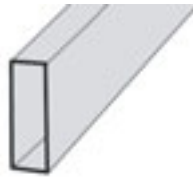

144B - 96	BLANC / WHITE	96"	50
-----------	---------------	-----	----

Moulure pour garde manger
Molding

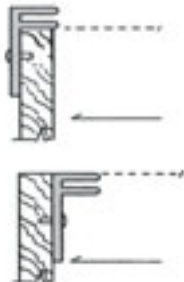

46600030	BLANC / WHITE	96"	100
----------	---------------	-----	-----

Moulure en F pour diviseur ustensiles
F molding for cutlery insert

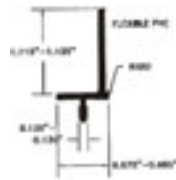
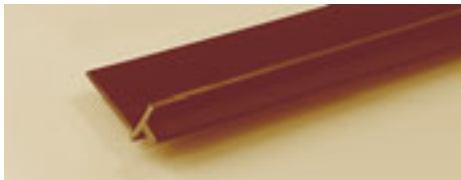

0169 - NR	NOIR / BLACK	69 3/4"	50
-----------	--------------	---------	----

Moulure passe-fils
Grommet molding

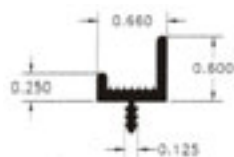
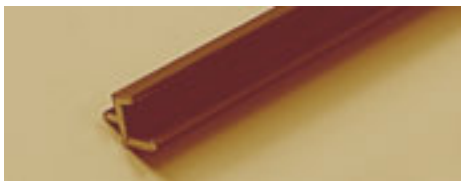

168P - 72	NOIR / BLACK	72"	50
-----------	--------------	-----	----

Extrusion de poignée
Handle extrusion

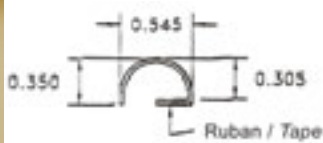



146N - 1/2	NOIR / BLACK	96"	50
------------	--------------	-----	----

Passe-fils autocollant
Self-adhesive wire manager

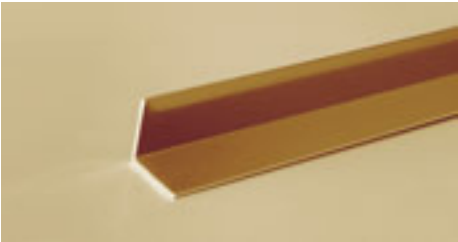
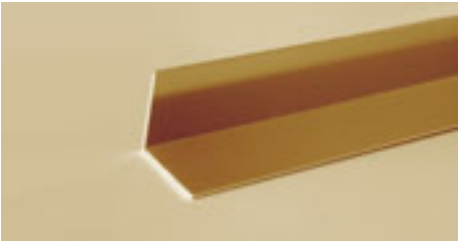
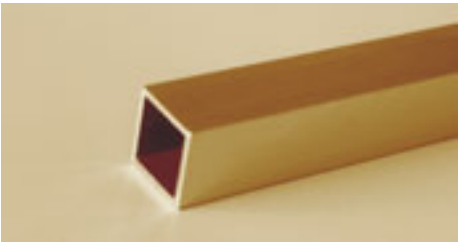
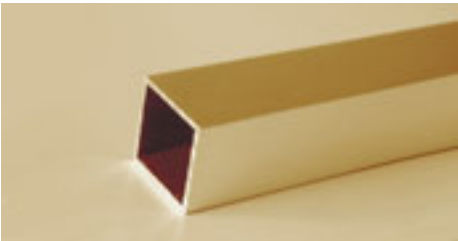

DURA*TRIM

MOULURES EN ALUMINIUM / ALUMINUM PROFILES

	# QUINKO-TEK	HAUTEUR HEIGHT	LARGEUR WIDTH	LONGEUR LENGTH	CALIBRE GAUGE	FINI FINISH	CAISSE CASE
	A1001 NR - 1/2	1/2"	1/2"	96"	1/16	NOIR / BLACK	5
	A1001 LT - 1/2	1/2"	1/2"	96"	1/16	LAITON / BRASS	5
	A1001 CH - 1/2	1/2"	1/2"	96"	1/16	CHROME / CHROME	5
	A1001 NR - 3/4	3/4"	3/4"	96"	1/16	NOIR / BLACK	5
	A1001 LT - 3/4	3/4"	3/4"	96"	1/16	LAITON / BRASS	5
	A1001 CH - 3/4	3/4"	3/4"	96"	1/16	CHROME / CHROME	5
	A1001 NR - 1	1"	1"	96"	1/16	NOIR / BLACK	5
	A1001 LT - 1	1"	1"	96"	1/16	LAITON / BRASS	5
	A1001 CH - 1	1"	1"	96"	1/16	CHROME / CHROME	5
	A1002 NR - 3/4	3/4"	3/4"	96"	1/16	NOIR / BLACK	5
	A1002 LT - 3/4	3/4"	3/4"	96"	1/16	LAITON / BRASS	5
	A1002 CH - 3/4	3/4"	3/4"	96"	1/16	CHROME / CHROME	5
	A1002 NR - 1	1"	1"	96"	1/16	NOIR / BLACK	5
	A1002 LT - 1	1"	1"	96"	1/16	LAITON / BRASS	5
	A1002 CH - 1	1"	1"	96"	1/16	CHROME / CHROME	5
	A1002 NR - 7/8	7/8"	7/8"	96"	1/16	NOIR / BLACK	5
	A1002 LT - 7/8	7/8"	7/8"	96"	1/16	LAITON / BRASS	5
	A1002 CH - 7/8	7/8"	7/8"	96"	1/16	CHROME / CHROME	5
	A1003 NR - 1/2	diam.	1/2"	96"	1/16	NOIR / BLACK	5
	A1003 LT - 1/2	diam.	1/2"	96"	1/16	LAITON / BRASS	5
	A1003 CH - 1/2	diam.	1/2"	96"	1/16	CHROME / CHROME	5

DURA*TRIM

MOULURES EN ALUMINIUM / ALUMINUM PROFILES







	# QUINKO-TEK	HAUTEUR HEIGHT	LARGEUR WIDTH	LONGEUR LENGTH	CALIBRE GAUGE	FINI FINISH	CAISSE CASE
	A1003 NR - 3/4	diam.	3/4"	96"	1/16	NOIR / BLACK	5
	A1003 LT - 3/4	diam.	3/4"	96"	1/16	LAITON / BRASS	5
	A1003 CH - 3/4	diam.	3/4"	96"	1/16	CHROME / CHROME	5
	A1003 NR - 1	diam.	1"	96"	1/16	NOIR / BLACK	5
	A1003 LT - 1	diam.	1"	96"	1/16	LAITON / BRASS	5
	A1003 CH - 1	diam.	1"	96"	1/16	CHROME / CHROME	5
	A1003 NR - 1 1/2	diam.	1 - 1/2"	96"	1/16	NOIR / BLACK	5
	A1003 LT - 1 1/2	diam.	1 - 1/2"	96"	1/16	LAITON / BRASS	5
	A1003 CH - 1 1/2	diam.	1 - 1/2"	96"	1/16	CHROME / CHROME	5
	A1004 NR - 1/2	-	1/2"	96"	3/32	NOIR / BLACK	5
	A1004 LT - 1/2	-	1/2"	96"	3/32	LAITON / BRASS	5
	A1004 CH - 1/2	-	1/2"	96"	3/32	CHROME / CHROME	5
	A1004 NR - 3/4	-	3/4"	96"	3/32	NOIR / BLACK	5
	A1004 LT - 3/4	-	3/4"	96"	3/32	LAITON / BRASS	5
	A1004 CH - 3/4	-	3/4"	96"	3/32	CHROME / CHROME	5
	A1004 NR - 1	-	1"	96"	3/32	NOIR / BLACK	5
	A1004 LT - 1	-	1"	96"	3/32	LAITON / BRASS	5
	A1004 CH - 1	-	1"	96"	3/32	CHROME / CHROME	5
	A1005 NR 1/2	1/2"	1/2"	96"	1/16	NOIR / BLACK	5
	A1005 LT 1/2	1/2"	1/2"	96"	1/16	LAITON / BRASS	5
	A1005 CH 1/2	1/2"	1/2"	96"	1/16	CHROME / CHROME	5

DURA*TRIM

MOULURES EN ALUMINIUM / ALUMINUM PROFILES

	# QUINKO-TEK	HAUTEUR HEIGHT	LARGEUR WIDTH	LONGEUR LENGTH	CALIBRE GAUGE	FINI FINISH	CAISSE CASE
	A1006 NR - 1/2	5/8"	1/2"	96"	1/16	NOIR / BLACK	5
	A1006 LT - 1/2	5/8"	1/2"	96"	1/16	LAITON / BRASS	5
	A1006 CH - 1/2	5/8"	1/2"	96"	1/16	CHROME / CHROME	5
	A1006 NR - 3/4	5/8"	3/4"	96"	1/16	NOIR / BLACK	5
	A1006 LT - 3/4	5/8"	3/4"	96"	1/16	LAITON / BRASS	5
	A1006 CH - 3/4	5/8"	3/4"	96"	1/16	CHROME / CHROME	5
	A1006 NR - 1	5/8"	1"	96"	1/16	NOIR / BLACK	5
	A1006 LT - 1	5/8"	1"	96"	1/16	LAITON / BRASS	5
	A1006 CH - 1	5/8"	1"	96"	1/16	CHROME / CHROME	5
	A1007 NR - 11/16	-	11/16"	96"	9/64	NOIR / BLACK	5
	A1007 LT - 11/16	-	11/16"	96"	9/64	LAITON / BRASS	5
	A1007 CH - 11/16	-	11/16"	96"	9/64	CHROME / CHROME	5
	A1008 NR - 3/4	-	3/4"	96"	3/32	NOIR / BLACK	5
	A1008 LT - 3/4	-	3/4"	96"	3/32	LAITON / BRASS	5
	A1008 CH - 3/4	-	3/4"	96"	3/32	CHROME / CHROME	5
	A1009 CH - 1 1/4	3/16"	1 - 1/4"	96"	1/16	CHROME / CHROME	5
	A1010 NR - 3/4	1/2"	3/4"	96"	1/16	NOIR / BLACK	5
	A1010 LT - 3/4	1/2"	3/4"	96"	1/16	LAITON / BRASS	5
	A1010 CH - 3/4	1/2"	3/4"	96"	1/16	CHROME / CHROME	5

MOULURES EN ALUMINIUM / ALUMINUM PROFILES

	# QUINKO-TEK	HAUTEUR HEIGHT	LARGEUR WIDTH	LONGEUR LENGTH	CALIBRE GAUGE	FINI FINISH	CAISSE CASE
	A1101 AN - 1/2	-	1/2"	96"	1/16	ANODISE / ANODIZED	5
	A1101 AN - 3/4	-	3/4"	96"	1/16		5
	A1101 AN - 1	-	1"	96"	3/32"		5
	A1101 AN - 1 1/4	-	1 - 1/4"	96"	3/32"		5
	A1102 AN - 1/2	1/2"	1/2"	96"	1/16	ANODISE / ANODIZED	5
	A1102 AN - 3/4	3/4"	3/4"	96"	1/16		5
	A1102 AN - 1	3/4"	1"	96"	3/32"		5
	A1102 AN - 1 1/4	3/4"	1 - 1/4"	96"	3/32"		5
	A1103 AN - 1/2	-	1/2"	96"	1/8"	ANODISE / ANODIZED	5
	A1103 AN - 3/4	-	3/4"	96"	1/8"		5
	A1103 AN - 1	-	1"	96"	1/8"		5
	A1103 AN - 1 1/4	-	1 - 1/4"	96"	1/8"		5
	A1104 AN - 1/2	1/2"	1/2"	96"	1/16	ANODISE / ANODIZED	5
	A1104 AN - 3/4	3/4"	3/4"	96"	1/16		5
	A1104 AN - 1	1"	1"	96"	3/32"		5
	A1104 AN - 1 1/4	1 - 1/2"	1 - 1/4"	96"	3/32"		5
	A1105 AN - 1/2	1/2"	1/2"	96"	1/16	ANODISE / ANODIZED	5
	A1105 AN - 3/4	3/4"	3/4"	96"	1/16		5
	A1105 AN - 1	1"	1"	96"	1/8"		5
	A1105 AN - 1 1/2	1 - 1/2"	1 - 1/2"	96"	1/8"		5
	A1105 AN - 2	2"	2"	96"	1/8"		5
	A1106 AN - 1	3/4"	1"	96"	1/8"	ANODISE / ANODIZED	5
	A1107 AN - 1/2	-	1/2"	96"	-	ANODISE / ANODIZED	5

MOULURES EN ALUMINIUM / ALUMINUM PROFILES



# QUINKO-TEK	HAUTEUR HEIGHT	LARGEUR WIDTH	LONGEUR LENGTH	CALIBRE GAUGE	FINI FINISH	CAISSE CASE
A1201 AN - 1 1/4	1 - 1/4"	1 - 1/4"	12'	1/16	ANODISE / ANODIZED	5
A1201 AN - 3	3"	3"	12'	1/8		5
A1201 AN - 4	4"	4"	12'	1/8		5

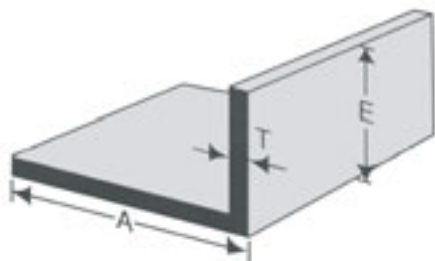

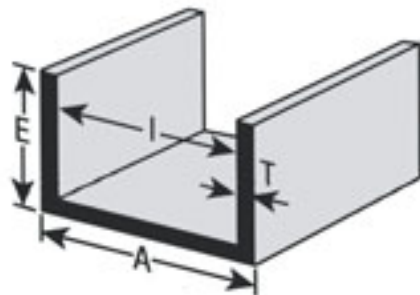

A1202 AN - 3/4	1/4"	3/4"	12'	1/16	ANODISE / ANODIZED	5
A1202 AN - 7/8	3/8"	7/8"	12'	1/16		5
A1222 AN - 3/4	1/2"	3/4"	12'	1/16		5
A1202 AN - 1	1/2"	1"	12'	1/16		5
A1202 AN - 1 1/2	1"	1 - 1/2"	12'	1/16		5
A1202 AN - 2	1"	2"	12'	1/16		5
A1202 AN - 3 1/2	1 - 1/16"	3 - 1/2"	12'	1/16		5
A1203 AN - 1	1/2"	1"	12'	1/8		5
A1223 AN - 1	3/4"	1"	12'	1/8		5
A1203 AN - 1 1/2	1"	1 - 1/2"	12'	1/8		5
A1203 AN - 2	1"	2"	12'	1/8		5
A1203 AN - 3	1"	3"	12'	1/8		5

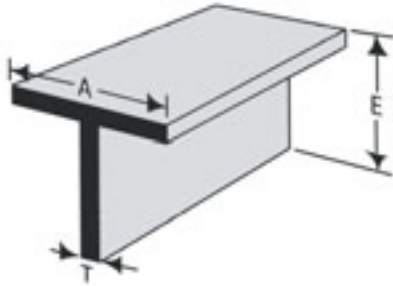

A1204 AN - 3/8	3/8"	3/8"	12'	1/16	1/4	ANODISE / ANODIZED	5
A1224 AN - 3/8	1/2"	3/8"	12'	1/16	1/4		5
A1204 AN - 1/2	1 - 1/4"	1/2"	12'	1/16	3/8		5
A1224 AN - 1/2	1/2"	1/2"	12'	1/16	3/8		5
A1204 AN - 5/8	5/8"	5/8"	12'	1/16	1/2		5
A1204 AN - 3/4	5/8"	3/4"	12'	1/16	5/8		5
A1204 AN - 7/8	5/8"	7/8"	12'	1/16	3/4		5
A1204 AN - 1 1/8	5/8"	1 - 1/8"	12'	1/16	1		5
A1205 AN - 3/4	3/4"	3/4"	12'	1/8	1/2		5
A1205 AN - 1	1/2"	1"	12'	1/8	3/4		5
A1205 AN - 1 1/4	5/8"	1 - 1/4"	12'	1/8	1		5
A1205 AN - 1 1/2	1/2"	1 - 1/2"	12'	1/8	1 - 1/4		5
A1205 AN - 1	1"	1"	12'	1/8	3/4		5
A1225 AN - 1 1/2	1"	1 - 1/2"	12'	1/8	1 - 1/4		5
A1205 AN - 1 3/4	3/4"	1 - 3/4"	12'	1/8	1 - 1/2		5
A1205 AN - 2	1"	2"	12'	1/8	1 - 3/4		5
A1225 AN - 2	1/2"	2"	12'	1/8	1 - 3/4		5
A1205 AN - 3	1"	3"	12'	1/8	2 - 3/4		5
A1235 AN - 2	3/4"	2"	12'	1/8	1 - 3/4		5

MOULURES EN ALUMINIUM / ALUMINUM PROFILES

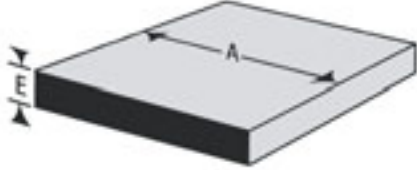
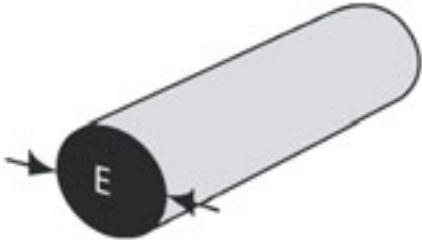
# QUINKO-TEK	HAUTEUR HEIGHT	LARGEUR WIDTH	LONGEUR LENGTH	CALIBRE GAUGE	FINI FINISH	CAISSE CASE	
	A1206 AN - 3/4	3/4"	3/4"	12'	1/8"	ANODISE / ANODIZED	5
	A1206 AN - 1	1"	1"	12'	1/8"		5
	A1206 AN - 2	2"	2"	12'	1/8"		5
	A1206 AN - 1 1/2	1 - 1/2"	1 - 1/2"	12'	1/4"		5
	A1206 AN - 2	2"	2"	12'	1/4"		5
	A1207 AN - 1/2		1/2"	12'	1/16	ANODISE / ANODIZED	5
	A1207 AN - 3/4		3/4"	12'	1/16		5
	A1207 AN - 1		1"	12'	3/16		5
	A1207 AN - 1 1/4		1 - 1/4"	12'	1/4		5
	A1207 AN - 2		2"	12'	1/4		5
	A1208 AN - 3/8		3/8"	12'	1/8	ANODISE / ANODIZED	5
	A1208 AN - 1/2		1/2"	12'	1/8		5
	A1208 AN - 5/8		5/8"	12'	1/8		5
	A1208 AN - 3/4		3/4"	12'	1/8		5
	A1208 AN - 1		1"	12'	1/8		5
	A1208 AN - 1 1/2		1 - 1/2"	12'	1/8		5
	A1208 AN - 2		2"	12'	1/8		5
	A1208 AN - 3		3"	12'	1/8		5
	A1208 AN - 4		4"	12'	1/8		5
	A1209 AN - 1/4		1/4"	12'	1/4		5
	A1209 AN - 3/4		3/4"	12'	1/4		5
	A1209 AN - 1		1"	12'	1/4		5
	A1209 AN - 1 1/2		1 - 1/2"	12'	1/4		5
	A1209 AN - 2		2"	12'	1/4		5
	A1209 AN - 3		3"	12'	1/4		5
A1209 AN - 5		5"	12'	1/4	5		
	A1210 AN - 1/4		1/4"	12'	ANODISE / ANODIZED	5	
	A1210 AN - 3/8		3/8"	12'		5	
	A1210 AN - 1/2		1/2"	12'		5	
	A1210 AN - 3/4		3/4"	12'		5	
	A1210 AN - 1		1"	12'		5	

MOULURES EN ALUMINIUM / ALUMINUM MOULDING PROFILES

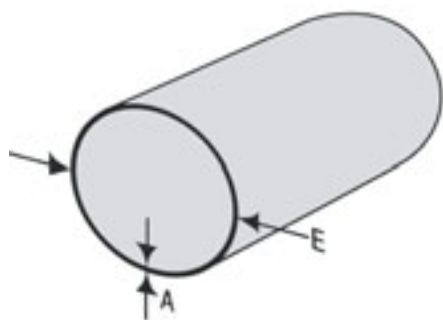

# QUINKO-TEK	HAUTEUR HEIGHT	LARGEUR WIDTH	LONGEUR LENGTH	CALIBRE GAUGE	FINI FINISH	CAISSE CASE
A1211 AN - 3/8		3/8"	12'	1/16	ANODISE / ANODIZED	5
A1211 AN - 1/2		1/2"	12'	1/16		5
A1211 AN - 5/8		5/8"	12'	1/16		5
A1211 AN - 3/4		3/4"	12'	1/16		5
A1211 AN - 7/8		7/8"	12'	1/16		5
A1211 AN - 1		1"	12'	1/16		5
A1211 AN - 1 1/4		1 - 1/4"	12'	1/16		5
A1211 AN - 1 1/2		1 - 1/2"	12'	1/16		5
A1211 AN - 2		2"	12'	1/16		5
A1211 AN - 3		3"	12'	1/8		5

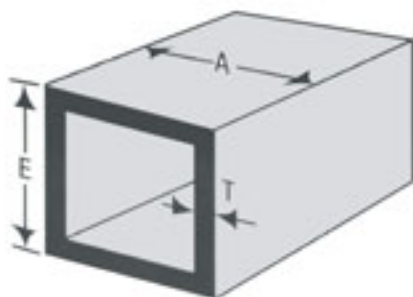

A1212 AN - 1/2	1/2"	1/2"	12'	1/16	ANODISE / ANODIZED	5
A1212 AN - 3/4	3/4"	3/4"	12'	1/16		5
A1212 AN - 1	1"	1"	12'	1/16		5
A1212 AN - 1 1/2	1 - 1/2"	1 - 1/2"	12'	1/16		5
A1213 AN - 2	2"	2"	12'	1/8		5
A1213 AN - 1 1/2	1"	1 - 1/2"	12'	1/8		5
A1213 AN - 2	1"	2"	12'	1/8		5
A1213 AN - 3	1"	3"	12'	1/8		5
A1233 AN - 3	1 - 1/4"	3"	12'	1/8		5

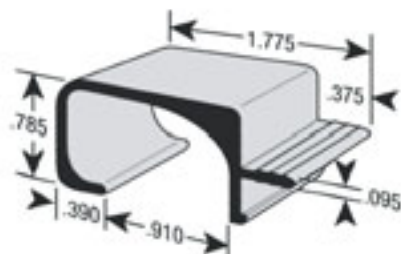

A1214 AN - 3/4	1 - 3/4"	3/4"	12'	-	ANODISE / ANODIZED	5
----------------	----------	------	-----	---	--------------------	---





STRATIFIÉS (HP) LAMINATES



ÉCONOMISEZ
20%
SAVINGS

Exigez **VOTRE** Mosaïque
Ask for **YOUR** Mosaic

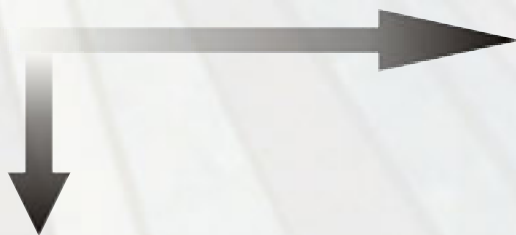



STRATIFIÉS (HP) LAMINATES

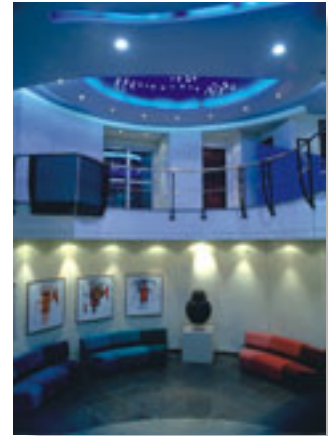

**Fabricant reconnu mondialement • Grades standards : GP et post-formable •
Qualité et service extraordinaires • Concept, motifs et couleurs avant-gardistes •
Sélection de motifs de bois exceptionnel • Toujours à la recherche d'innovation
et de nouvelles idées • Librairie exceptionnelle d'applications**

www.quinkotek.com/lamitech

***World Class Manufacturer • General Purpose and Post-Forming Grades •
Extraordinary Quality and Service • Leading Edge Designs, Patterns and Colors •
Exceptional Selection of Wood Grains • Always Striving for Innovation
and New Ideas • An Outstanding Library of Applications***

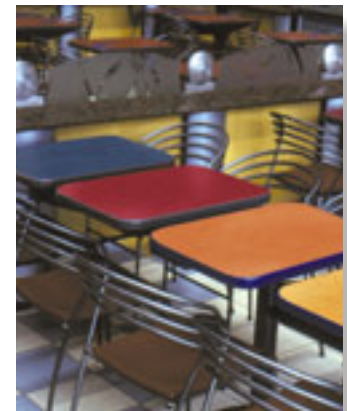

OLON



BANDE DE CHANT EDGE BANDING

895B - 3/4" = BLANC / WHITE

895A - 3/4" = AMANDE / ALMOND

895G - 3/4" = GRIS / GREY

895GF - 3/4" = GRIS FONCÉ / DARK GREY

895N - 3/4" = NOIR / BLACK

AUTRES DIMENSIONS DISPONIBLES EN INVENTAIRE OU SUR COMMANDE
OTHER DIMENSIONS AVAILABLE FROM STOCK OR ON ORDER

OLON



BANDE DE CHANT WOOD VENEER TAPE

ENCOLLÉ / PREGLUED

890E - 13/16" = 13/16" x 250' ERABLE / MAPLE

890C - 13/16" = 13/16" x 250' CHÊNE / OAK

890M - 13/16" = 13/16" x 250' MERISIER / BIRCH

NON-ENCOLLÉ / WITHOUT GLUE

893E - 7/8" = 7/8" x 250' ERABLE / MAPLE

893C - 7/8" = 7/8" x 250' CHÊNE / OAK

893M - 7/8" = 7/8" x 250' MERISIER / BIRCH

AUTRES DIMENSIONS DISPONIBLES EN INVENTAIRE OU SUR COMMANDE
OTHER DIMENSIONS AVAILABLE FROM STOCK OR ON ORDER

Dura Edge

P.V.C.
P.V.C.



QUINKO-TEK DISTRIBUE UNE GRANDE QUANTITÉ DE P.V.C. DE DIFFÉRENTES TAILLES, EN PLUS DE VOUS OFFRIR UNE LARGE GAMME DE COULEURS ET DIMENSIONS SUR DEMANDE. NOUS VOUS PROPOSONS ÉGALEMENT UN PROGRAMME DE COULEURS QUI S'ASSORTIRONT À PLUSIEURS FINIS DE MÉLAMINE. VOUS DEVRIEZ TOUJOURS EXIGER ET FAIRE APPROUVER DES ÉCHANTILLONS DE CORRESPONDANCE AVANT DE COMMANDER.

QUINKO-TEK DISTRIBUTES LARGE QUANTITIES AND DIFFERENT SIZES OF P.V.C. AS WELL AS HAVING A VAST ARRAY OF STANDARD COLORS AND DIMENSIONS AVAILABLE. WE ALSO HAVE A PVC COLOR PROGRAM WITH COLORS THAT MATCH MANY MELAMINE FINISHES. SAMPLES OF MATCHES SHOULD ALWAYS BE REQUESTED AND APPROVED BEFORE ORDERING.

Fastedge

P.V.C. ENCOLÉE
PREGLUED P.V.C.



ROULEAUX CONTINUS DE BANDE ADHESIVE DE BORDURE, DÉTACHABLE ET COLLANTE, QUI PEUT SERVIR À PLUSIEURS APPLICATIONS. ENDUITS D'ADHÉSIF À PRESSION SENSIBLE DE HAUTE PERFORMANCE, LES ROULEAUX OFFRENT UNE ADHÉSION INSTANTANÉE ET PEUVENT ÊTRE DÉLIGNÉS AVEC UN DÉLIGNEUR OU UN COUTEAU UTILITAIRE.

CONTINUOUS ROLLS OF SELF ADHESIVE PEEL AND STICK EDGE BANDING THAT CAN BE USED FOR MANY APPLICATIONS. COATED WITH A HIGHLY AGGRESSIVE PRESSURE SENSITIVE ADHESIVE (PSA) WHICH WILL ALLOW FOR AN INSTANT BOND AND CAN BE EASILY TRIMMED WITH A TRIMMER OR UTILITY KNIFE.

**RECOUVREMENT DE HAUTE PERFORMANCE (BACKER)
HIGH PERFORMANCE BACKER OVERLAYS**

- ✓ Leader mondial dans la technologie du recouvrement
- ✓ Recouvre ou balance les panneaux avec du HPL ou des planches de placage
- ✓ Application à la presse chaude ou froide
- ✓ Saturé avec des phénoliques haute résistance
- ✓ Performance d'humidité de haut niveau
- ✓ Disponible en feuilles de 4' x 8' pieds et de 5' x 12', et aussi en rouleaux « coupez-le vous-même » de largeurs 37", 49" et 61".

- ✓ *World Leader in Overlay Technology*
- ✓ *To Balance and Back Panels with HPL or Veneer Faces*
- ✓ *Hot or Cold Press Applications*
- ✓ *Saturated with High Strength Phenolics*
- ✓ *High Moisture Barrier Performance*
- ✓ *4' x 8' and 5' x 12' or "Cut to Size" from Rolls (widths 37", 49", 61")*

**ÉCHANTILLONS
GRATUITS
FREE SAMPLES**

Là-dessous... ce doit être Dynea !

***Underneath it all...
it has to be Dynea !***

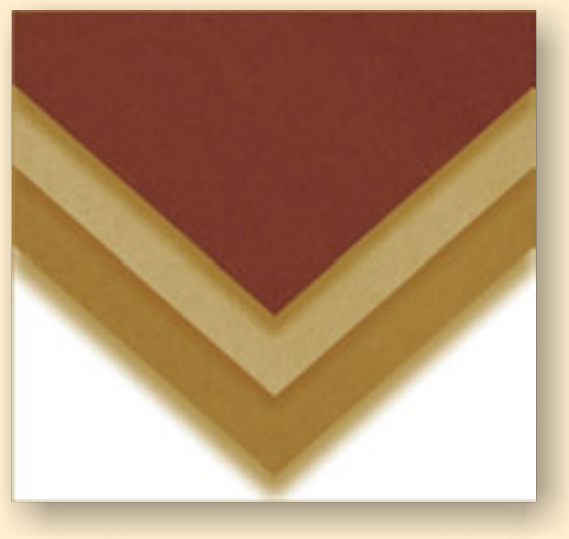

**RECOUVREMENT DE HAUTE PERFORMANCE (BACKER)
HIGH PERFORMANCE BACKER OVERLAYS**

Augmenter vos profits
Increase Your Profits

Efficacité / *Efficiency*

Performance

Économie / *Savings*

- ✓ Prix imbattables
 - ✓ Performance exceptionnelles (la plus forte adhésion sur le marché - plus de 400 psi) ;
 - ✓ Gratuit - feuilles d'échantillons - faites la preuve vous-même ;
 - ✓ Pas de machines onéreuses - applications à la presse chaude, froide, ou application manuelle ;
 - ✓ Aucun sablage requis - uniformité de couleur sur les 2 côtés - on peut appliquer la colle sur l'une ou l'autre des faces ;
 - ✓ Utilise moins de colle qu'avec les feuilles pré-sablées (*regrind*) ;
 - ✓ Excellente propriété mécanique - moins d'usure et moins de déchirure par la lame de la scie.
- ✓ *Unbeatable prices ;*
 - ✓ *Exceptional performance (the strongest adhesion on the market - more than 400 psi) ;*
 - ✓ *Free sample sheets - see for yourself ;*
 - ✓ *No costly machinery - hot or cold press application ;*
 - ✓ *No sanding needed - uniformity on both sides - you can apply the glue on either of the sides ;*
 - ✓ *Uses less glue than regrind sheets ;*
 - ✓ *Excellent mechanical properties - less wear and tear on saws.*

HELMITIN

PRODUITS ADHÉSIFS ADHESIVE PRODUCTS



# QUINKO-TEK	# HELMITIN	COULEUR COLOR	DESCRIPTION	QUANT.
0840-BL	O430	BLANC - WHITE	COLLE GRANULÉE GRANULATED HOT MELT	20 KILOS
0840-NT	O432	NATUREL - NATURAL	COLLE GRANULÉE GRANULATED HOT MELT	20 KILOS
0840-NR	O431	NOIR - BLACK	COLLE GRANULÉE GRANULATED HOT MELT	20 KILOS
0840-TR	0495	CLAIR - CLEAR	COLLE GRANULÉE GRANULATED HOT MELT	20 KILOS
0840-HB	O480	BLANC - WHITE	HAUTE VITESSE - HIGH SPEED	20 KILOS
0840-HP	0405	NATUREL - NATURAL	POUR CONTOURS - CONTOUR	20 KILOS
0840-NE	0499	CLAIR - CLEAR	NETTOYANT POUR MACHINE HOT MELT CLEANER	2 KILOS
0840-HN	O482	NATUREL - NATURAL	HAUTE VITESSE - HIGH SPEED	20 KILOS



0841 - BL	0480C	BLANC - WHITE	COLLE EN CARTOUCHE CARTIDGE GLUE	CAISSE (CASE) = 45
0841 - CL	0495C	CLAIR - CLEAR	COLLE EN CARTOUCHE CARTIDGE GLUE	CAISSE (CASE) = 45
0841 - NT	0482C	NATUREL - NATURAL	COLLE EN CARTOUCHE CARTIDGE GLUE	CAISSE (CASE) = 45



882C - 04	0847	BLANC - WHITE	COLLE BLANCHE WHITE GLUE	3.78 L.
881W - 04	47-190-3	BLANC - WHITE	COLLE CONTACT À BASE D'EAU WATER BASED CONTACT GLUE	3.78 L.
882C - 20	0847	BLANC - WHITE	COLLE BLANCHE WHITE GLUE	18.9 L.
881W - 20	47-190-3	BLANC - WHITE	COLLE CONTACT À BASE D'EAU WATER BASED CONTACT GLUE	18.9 L.
881E - 20	8320-6	BLANC - WHITE	COLLE BLANCHE WHITE GLUE	18.9 L.
882G - 20	F43-75	BLANC - WHITE	COLLE À GOUGONS DOWEL ADHESIVE	18.9 L.
882J - 20	0858	JAUNE - YELLOW	COLLE JAUNE YELLOW GLUE	18.9 L.
882R - 20	0856	BLANC - WHITE	COLLE BLANCHE WHITE GLUE	18.9 L.



881P - 04	C1325	NATUREL - NATURAL	COLLE CONTACT BASE SOLVANT SOLVANT BASED CONTACT GLUE	3.78 L.
881P - 20	C1325	NATUREL - NATURAL	COLLE CONTACT BASE SOLVANT SOLVANT BASED CONTACT GLUE	18.9 L.
883S - 04	CO685	-	SOLVANT SOLVANT	3.78 L.
883S - 20	CO685	-	SOLVANT SOLVANT	18.9 L.
881V - 20	4005R	ROUGE - RED	COLLE CONTACT VAPORISABLE SPRAYABLE CONTACT GLUE	18.9 L.
881VC - 20	4005	CLAIR - CLEAR	COLLE CONTACT VAPORISABLE SPRAYABLE CONTACT GLUE	18.9 L.

ACCESSOIRES DE CUISINE / KITCHEN ACCESSORIES

# QUINKO-TEK	DIMENSIONS	COULEUR COLOR	CAISSE CASE
	800B - 11 11" x 2" x 3" 800B - 14 14" x 2" x 3" 800B - 24 24 - 1/4" x 2" x 3" 800B - 30 30 - 1/4 x 2" x 3"	BLANC / WHITE	10 10 10 10
Panier faux tiroir Drawer front basket			
	801M - CH	-	10
Mécanisme d'ouverture pour 801-CH Drawer opening mechanism for 801-CH			
	800K - BL	120x430x90mm	1
Panier faux tiroir à largeur ajustable Drawer front basket with adjustable length			
	803P - BL	170x430x90mm	1
Support a serviette Extendible towel rods			
	802M - BL	140x430x120mm	1
Support a serviette Extendible towel rods			
	803M - BL	190x430x170mm	1
Support a serviette Extendible towel rods			

ACCESSOIRES DE CUISINE / KITCHEN ACCESSORIES

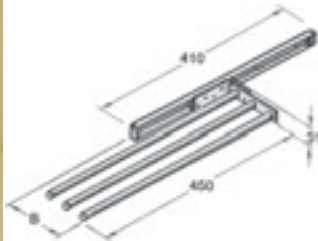

# QUINKO-TEK	DIMENSIONS	COULEUR COLOR	CAISSE CASE
803C 450		CHROME / CHROME	1
Support a serviette Extendible Towel Rod			



8815 - BL	15 lit	BLANC / WHITE	1
Poubelle Waste bin			



808B - 20	20 lit	BLANC / WHITE	1
Poubelle Waste bin			

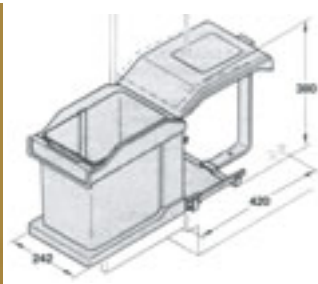
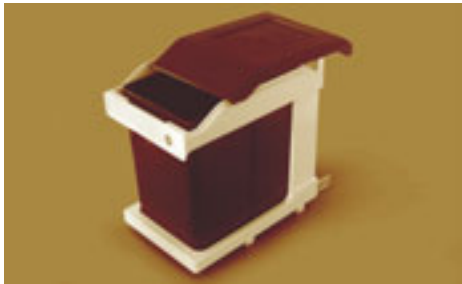

809 BR - 20	20 lit	BRUN / BROWN	1
Poubelle Waste bin			

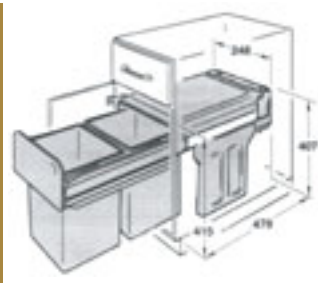



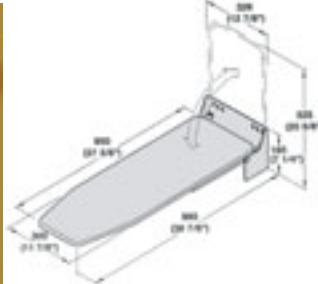
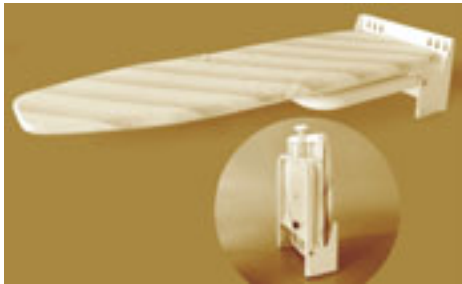



8825 - BL	2 x 15 lit	BRUN / BROWN VERT / GREEN	1
Poubelle Waste bin			



806 BG - 950	-	BLANC / WHITE GRIS / GRAY	1
Centre de repassage mural Wall mount ironing board			

ACCESSOIRES DE CUISINE / KITCHEN ACCESSORIES

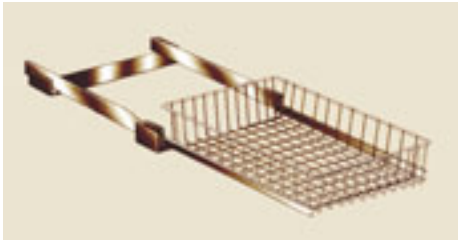
# QUINKO-TEK	VOL	HAUTEUR HEIGHT	LARGEUR WIDTH	LONGUEUR LENGTH	FINIS FINISH	CAISSE CASE	
	812B - 20	20q	16"	9"	22"	BLANC / WHITE	1
	813B - 20	20q	19 - 1/2"	9 - 1/2"	22"	BLANC / WHITE	1
	813P - BL	20q	Poubelle remplacement # 813B - 20 Replacement bin for # 813B - 20		22"	BLANC / WHITE	1
Poubelle coulissante Extendible waste bin							
	814B - 30	30q	19 - 1/2"	16 - 1/2"	16"	BLANC / WHITE	1
	815B - 60D	2 x 60q	16"	16 - 1/2"	22"	BLANC / WHITE	1
Poubelle coulissante Extendible waste bin							
	816B - 20	20q	19 - 1/2"	10 - 1/2"	22"	BLANC / WHITE	1
	817B - 20	20q	16"	15"	22"	BLANC / WHITE	1
	818B - 30	30q	20"	16 - 1/2"	22"	BLANC / WHITE	1
Poubelle coulissante Extendible waste bin							
	819B - 27D	2 x 27q	19"	12"	23"	BLANC / WHITE	1
	Poubelle coulissante Extendible waste bin						
	820B - 40D	2 x 40q	16"	15"	22"	BLANC / WHITE	1
	Poubelle coulissante Extendible waste bin						
	821B - 20D	2 x 20q	19 - 1/2"	15"	22"	BLANC / WHITE	1
	Poubelle coulissante Extendible waste bin						
	822B - 11		5"	11"	18 - 7/8"	BLANC / WHITE	1
	822B - 14		5"	14"	18 - 7/8"	BLANC / WHITE	1
Panier coulissant Extendible wire basket							

ACCESSOIRES DE CUISINE / KITCHEN ACCESSORIES

	# QUINKO-TEK	DIMENSIONS	COULEUR COLOR	CAISSE CASE
	805B - 16 - 1/4 805B - 15 - 1/4 805B - 14 - 1/2	16 - 1/4" H 15 - 1/4" LG 14 - 1/2" Prf	BLANC / WHITE	1
Tabouret escamotable <i>Folding mini step ladder</i>				
	51419140 (A) 51722030 (B)	1 - 5/8 x 1 - 1/8 x 5 - 5/8" 5 - 1/2 x 15 - 1/4"	ZINC / ZINC BLANC / WHITE	1 1
Support à verres en broche <i>Wire glass support</i>				
	0210 - LT 0210 - SN 0210 - CH 0210 - NR	15/16 x 3 - 3/4 x 10 - 3/8" 15/16 x 3 - 3/4 x 10 - 3/8"	LAITON / BRASS NICKEL SAT. / SAT. NICKEL CHROME / CHROME NOIR / BLACK	10 10 10 10
Support à verres en broche <i>Wire glass support</i>				
	804B -SRP	15 - 1/2 x 9 - 1/4 x 5 - 1/4"	BLANC / WHITE	1
Système de rangement pour panier <i>Basket storage system</i>				
	51151140	8 - 1/2 x 9 x 5 - 1/2"	CHROME / CHROME	1
Support à verres en broche <i>Wire glass support</i>				
	811B - 11 811B - 14	11" lg 14 - 1/4 x 18 - 3/4" 14" lg x 14 - 1/4 x 18 - 3/4"	BLANC / WHITE BLANC / WHITE	1 1
Panier coulissant <i>Extendible wire basket</i>				









OUTILLAGE ET ACCESSOIRES / TOOLS AND ACCESSORIES

	# QUINKO-TEK	CAISSE CASE
	W091 - TR (A) W091 - LM (B)	1 1
Dégigneuse pour bande de chant (B) lames de rechange <i>Edge banding trimmer (B) replacement blade set</i>		
	W093 - TR	1
Dégigneur pour stratifiés <i>Plastic laminate slitter</i>		
	W078 - R3	1
Rouleau pour stratifié 3", manche 17" <i>3" laminate roller, 17" handle</i>		
	W079 - R8	1
Rouleau pour stratifié 7 - 1/4", manche extensible à 27" <i>7 - 1/4" laminate roller, handle extends to 27"</i>		
	W077 - ZR	1
Rouleau pour chant <i>Squeeze roller</i>		
	W092 - CT	12
Couteau pour stratifié avec pointe carbure <i>Laminate cutter carbide tipped</i>		
	W080 - CT W080 - LM (A)	1 1
Couteau tout usage (A), lames remplacement 50pcs <i>Heavy-duty cutter (A), replacement blades 50pcs</i>		







OUTILLAGE ET ACCESSOIRES / TOOLS AND ACCESSORIES

	# QUINKO-TEK	COULEUR COLOR	CAISSE CASE
	W302L - 10	-	10
Lime 10" pour stratifié coupe douce <i>10" laminate file smooth finish</i>			
	W301L - 10	-	10
Lime 10" pour stratifié coupe rapide <i>10" laminate file fast cutting</i>			
	W300L - 10	-	10
Lime 10" combine pour stratifié douce / rapide <i>10" duplex laminate file</i>			
	554C - AS	-	1
Mèche ajustable <i>Multisize hole cutter</i>			
	0554 - 1/4 0554 - 3/8 0554 - 1/2	1/4" 3/8" 1/2"	1 1 1
Fraiseuse avec mèche <i>Countersink with drill</i>			
	554C - 26 554C - 35 554C - 40	26mm 35mm 40mm	1 1 1
Mèche au carbure pour penture <i>Carbon steel bit for hinges</i>			
	W071 - R3	-	10
Rouleau colle économique 3" <i>3" adhesive economic roller</i>			
	W072 - BC	-	1
Bac pour colle <i>Adhesive roller tray</i>			





MÈCHES / BITS

	# QUINKO-TEK	LONGEUR LENGTH	CODE	VIS SCREWS	CAISSE CASE
	569S - 01	1"	# 0	4	50
	569S - 11	1"	# 1	6	50
	569S - 21	1"	# 2	8	50
	569S - 31	1"	# 3	10	50
	569S - 02	2"	# 0	4	50
	569S - 12	2"	# 1	6	50
	569S - 22	2"	# 2	8	50
	569S - 32	2"	# 3	10	50
	569S - 03	3"	# 0	4	50
	569S - 03	3"	# 1	6	50
	569S - 03	3"	# 2	8	50
	569S - 03	3"	# 3	10	50
	569S - 06	6"	# 0	4	50
	569S - 16	6"	# 1	6	50
	569S - 26	6"	# 2	8	50
	569S - 36	6"	# 3	10	50
	569P - 21	1"	pozidrive	-	50
	569P - 22	2"	pozidrive	-	50
	569R- AM	3"	-	-	10
	554C - 1/4	-	1/4	# 4	10
	554C - 3/8	-	3/8	# 6	10
	554C - 1/2	-	1/2	# 8	10





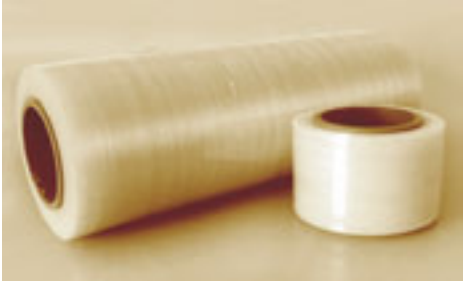

ADHESIFS ET ACCESSOIRES / ADHESIVES AND ACCESSORIES

	# QUINKO-TEK	DESCRIPTION	CAISSE CASE
	W030 - LT	Applicateur Polygun 3M à basse température modèle LT <i>Polygun LT applicator designed for low-melt Jet-Malt adhesives</i>	1
	W030 - EC	Applicateur Polygun EC - 3M Applicateur a grand rendement avec régulateur de température <i>Polygon EC applicator The versatile applicator for a wide Range of jobs with a module to choose pre-set temperature</i>	1
	Wc30 - M	Adhesive a temps de prise moyen pour bois Type base température Caisse 11lbs. (5/8 x 8") # 3778 <i>Wood adhesive Medium bonding time 11lbs. per case (5/8 x 8") # 3778</i>	1
	Wc30 - L	Adhesive tout usage pour bois et plastiques débit rapide et temps de prise long Caisse 11lbs. (5/8 x 8") # 3738 <i>Fast delivery For wood and plastic Long binding time 11lbs. per case (5/8 x 8") # 3738</i>	1
	Wc30 - TE	Adhesive tout usage pour plastique, bois et métaux de calibre léger, résistance Thermique élevée Caisse 11lbs. (5/8 x 8") # 3747 <i>General purpose adhesive Plastic, wood and metal Good thermal stability 11lbs. per case (5/8 x 8") # 3747</i>	1
	839SL - CL 839SL - BL 839SL - GR 839SL - NR 839SL - AM	CLAIR / CLEAR BLANC / WHITE GRIS / GRAY NOIR / BLACK AMANDE / ALMOND Silicone cartouche 300ml 300ml silicone tube	20 20 20 20 20

RUBANS / TAPES

	# QUINKO-TEK	DIMENSION	CAISSE CASE
	W051B - 3/4 W051B - 1-1/2 W051B - 2	3/4" 1 - 1/2" 2"	96 48 24
Ruban a masquer <i>Masking tape</i>			
	W051C - 48	48mm	48
Ruban pour emballage <i>Sealing tape</i>			
	W052DF - 54 W052DF - 108	1/8 x 3/4" x 54' 1/18 x 3/4" x 108'	16 16
Ruban collant double face <i>Double sided tape</i>			
	W050 - R3 W050 - R14 W050 - R18	3" 14" 18"	20 4 4
Film pour emballage <i>Stretch wrap</i>			
	W051 - P	-	1
Distributeur pour ruban emballage clair <i>Tape dispensers for sealing tape</i>			
	W050 - P	-	1
Poignee pour film emballage <i>Applicator handle for Stretch wrap</i>			

CORRECTEUR SEAMFIL / SEAMFIL FILLER

# QUINKO-TEK	CODE ADDITIF GLOSS CODE	COULEUR COLOR	CAISSE CASE	
	0839 - BL	901	BLANC / WHITE	12
	0839 - GR	902	GRIS / GRAY	12
	0839 - GF	903	GRIS FONCÉ / DARK GRAY	12
	0839 - TAN	904	TAN / TAN	12
	0839 - BR	913	BRUN / BROWN	12
	0839 - NR	914	NOIR / BLACK	12
	0839 - JN	916	JAUNE / YELLOW	12
	0839 - AC	918	ACAJOU / MAHOGANY	12
	0839 - RS	919	ROSE / PINK	12
	0839 - RO	922	ROUGE / RED	12
	0839 - BA	925	BLANC ANTIQUE / ANTIQUE WHITE	12
	0839 - GP	927	GRIS PALE / LIGHT GREY	12
	0839 - ER	931	ERABLE / MAPLE	12
	0839 - TE	933	TECK / TEAK	12
	0839 - NY	934	NOYER / WALNUT	12
	0839 - ME	935	MERISIER / BIRCH	12
	0839 - JP	936	JAUNE PRIMAIR / PRIMARY YELLOW	12
	0839 - RP	937	ROUGE PRIMAIR / PRIMARY RED	12
	0839 - BL	938	BLEU FONCÉ / DARK BLUE	12
	0839 - OL	939	OLIVE / OLIVE	12
	0839 - OR	940	ORANGE / ORANGE	12
	0839 - AM	941	AMANDE / ALMOND	12
	0839 - VS	945	VERT SPECTRUM / SPECTRUM GREEN	12
	0839 - BS	946	BLEU SPECTRUM / SPECTRUM BLUE	12
	0839 - ADL		Aditif lustré Seamfil pour reparation de laminés lustré <i>Clear gloss mix for gloss Laminate repair</i>	12
	0839 - RT		Retardeur pour Seamfil prolonge le temps séchage durant mixage <i>Seamfil retarder - prolongs drying time</i>	12
	K839 - SL		Trousse Seamfil standard <i>Seamfil Kit (solid color)</i>	1
	K839 - GB		Trousse Seamfil (grain de bois) <i>Seamfil kit (woodgrain)</i>	1
	0839 - DL		Diluant Seamfil <i>Seamfil solvent</i>	6

CORRECTEURS / FILLERS

	# QUINKO-TEK	CODE CRAYON PENCIL CODE	COULEUR COLOR	CAISSE CASE
	<p>0837 - AN 0837 - AM 0837 - ER 0837 - BL 0837 - EC 0837 - CN 0837 - BG 0837 - VT 0837 - NC 0837 - BC 0837 - EM 0837 - CP 0837 - PR 0837 - CR 0837 - BA 0837 - AP 0837 - AF 0837 - NR 0837 - AM 0837 - BP 0837 - GR</p>	<p>230-0101 230-0115 230-0225 230-0202 230-0240 230-0504 230-0303 230-0314 230-0332 230-0334 230-0360 230-0402 230-0404 230-0428 230-0412 230-0218 230-0227 230-0224 230-0275 230-0401 230-1476</p>	<p>AMBRE NATURE / NATURAL AMBER ACAJOU MOYEN / MEDIUM MAHOGANY ERABLE / MAPLE BLANC / WHITE ERABLE COLONIAL / COLONIAL MAPLE CHÈNE / OAK BEIGE / BEIGE VERT / GREEN CHENE NORDIC / NORDIC OAK BLANC CASSÉ / OFF WHITE ERABLE MIEL / HONEY MAPLE CHAMPAGNE / CHAMPAGNE POIRIER / PEARWOOD CERISIER / CHERRY BLANC ANTIQUE / ANTIQUE WHITE ACAJOU PÂLE / LIGHT MAHOGANY ACAJOU FONCÉ / DARK MAHOGANY NOIR / BLACK AMANDE / ALMOND BEIGE PALE / LIGHT BEIGE GRIS / GRAY</p>	<p>12 12</p>
	<p>837F - BL 837F - NR 837F - AJ 837F - VT</p>	<p>260-0202 260-224 260-0227 260-0314</p>	<p>BLANC / WHITE NOIR / BLACK ACAJOU / MAHOGANY VERT / GREEN</p>	<p>10 10 10 10</p>
	<p>0837 - KT</p>	<p>M230-5200</p>	<p>Ensemble de crayons cire 52 morceaux 52 piece wax pencil kit</p>	<p>1</p>
	<p>0882 - CT</p>	<p>-</p>	<p>Bouteille plastique pour colle Empty bottle for glue</p>	<p>100</p>

ABRASIVES / ABRASIVES



# QUINKO-TEK	CALIBRE GRADE	DIMENSIONS	CAISSE CASE
321C - 60	60	3 x 21	10
321C - 80	80	3 x 21	10
321C - 100	100	3 x 21	10
321C - 120	120	3 x 21	10

Courroies à sabler 3 x 21", grade bois K35
Belt for sanding 3 x 21", wood grade K35



324C - 60	60	3 x 24	10
324C - 80	80	3 x 24	10
324C - 100	100	3 x 24	10
324C - 120	120	3 x 24	10

Courroies à sabler 3 x 24", grade bois K35
Belt for sanding 3 x 24", wood grade K35



424C - 60	60	4 x 24	10
424C - 80	80	4 x 24	10
424C - 100	100	4 x 24	10
424C - 120	120	4 x 24	10

Courroies à sabler 4 x 24", grade bois K35
Belt for sanding 4 x 24", wood grade K35



DIS / V5C - 60	60	5" Velcro	100
DIS / V5C - 100	100	5" Velcro	100
DIS / V5C - 120	120	5" Velcro	100
DIS / V5C - 150	150	5" Velcro	100
DIS / V5C - 180	180	5" Velcro	100
DIS / V5C - 220	220	5" Velcro	100

Disque à sabler 5" type Velcro
5" Velcro sanding disc



DIS / V6C - 60	60	6" Velcro	100
DIS / V6C - 100	100	6" Velcro	100
DIS / V6C 120	120	6" Velcro	100
DIS / V6C 150	150	6" Velcro	100
DIS / V6C - 180	180	6" Velcro	100

Disque à sabler 6" type Velcro
6" Velcro sanding disc

ABRASIVES / ABRASIVES



# QUINKO-TEK	CALIBRE GRADE	DIMENSIONS	CAISSE CASE
DIS / AC6C - 80	80	6"	10
DIS / AC6C - 100	100	6"	10
DIS / AC6C - 120	120	6"	10
DIS / AC6C - 150	150	6"	10
DIS / AC6C - 180	180	6"	10
DIS / AC6C - 220	220	6"	10

Disque a sable 6" auto-collant
6" self-adhesive disc



FE / 911C - 80	80	9 x 11"	100
FE / 911C - 100	100	9 x 11"	100
FE / 911C - 120	120	9 x 11"	100
FE / 911C - 150	150	9 x 11"	100
FE / 911C - 180	180	9 x 11"	100
FE / 911C - 220	220	9 x 11"	100

Papier sable en feuilles 9 x 11", pour bois
Sand paper for wood 9 x 11"



FE / 35C - 100	100	2 - 3/4 x 5"	100
FE / 35C - 120	120	2 - 3/4 x 5"	100
FE / 35C - 180	180	2 - 3/4 x 5"	100
FE / 35C - 220	220	2 - 3/4 x 5"	100

Papier sable pour bois 2 - 3/4 x 5"
Sand paper for wood 2 - 3/4 x 5"

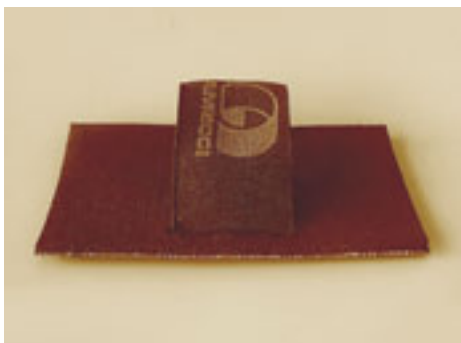

FE / V35C - VL	-	2 - 3/4 x 5"	10
----------------	---	--------------	----

Mitaine en Velcro pour papier 2 - 3/4 x 5"
Velcro hand pad for 2 - 3/4 x 5" sheet



DIS / 5C - 2C	-	5"	10
DIS / 6C - 2C	-	6"	10

Disque Velcro double cotés
Double face Velcro disc

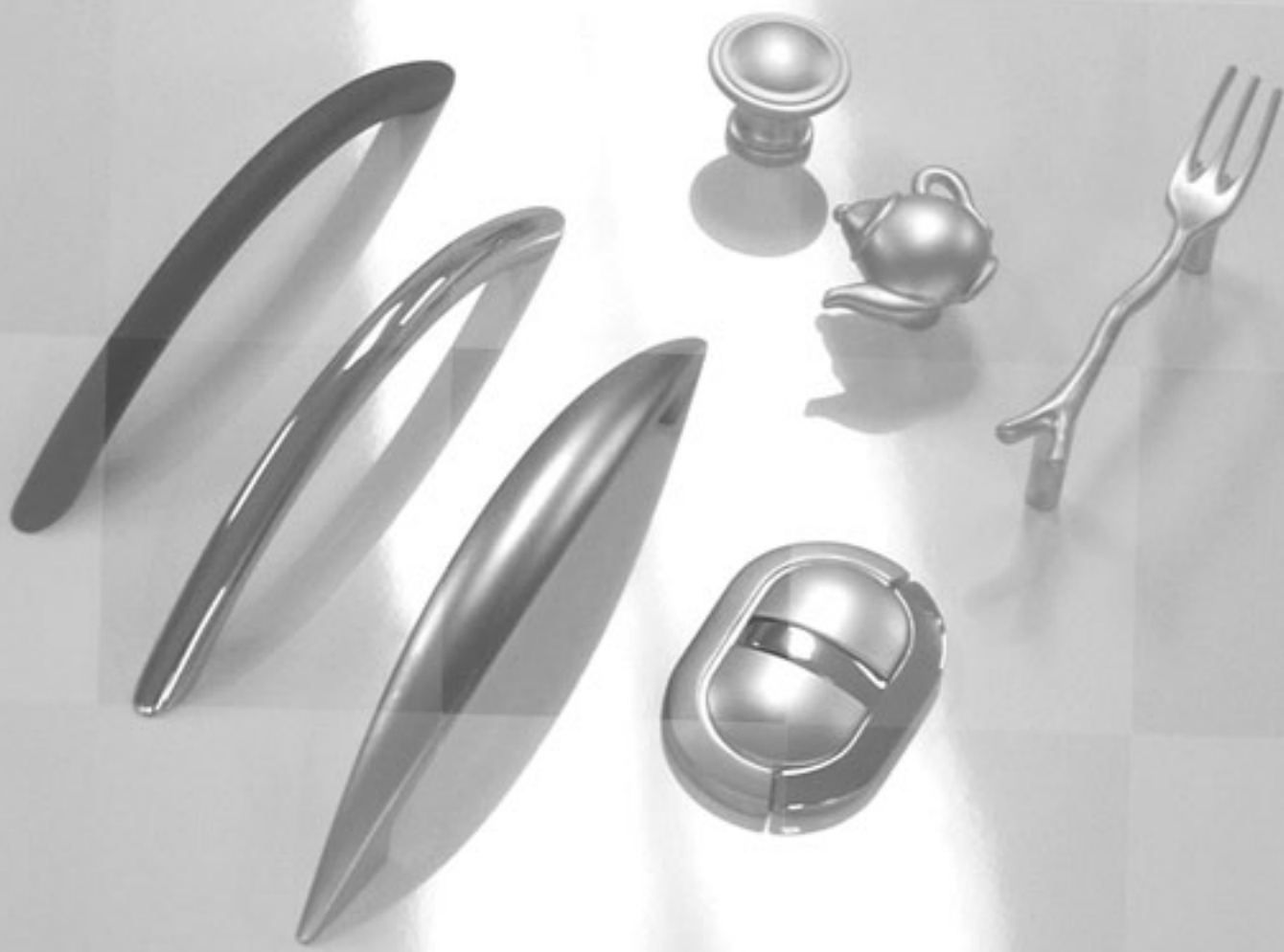

Q line poignées et crochets / handles and hooks

Notes / Notes

Les poignées et les boutons représentés dans les pages suivantes sont affichés à titre indicatif. La plupart d'eux sont disponibles dans un grand nombre de finis et couleurs et la liste ci-contre énumère la plupart de ces finis. Nous vous invitons à consulter un de nos spécialistes pour obtenir des échantillons spécifiques à vos besoins particuliers, des dessins techniques ou encore pour vous aider dans toute autre démarche.

Les couleurs et finis représentés dans les pages suivantes peuvent différer sensiblement des couleurs et finis réels.

The handles and knobs shown in the following pages are representations. Most of them are available in numerous finishes and colors and the list to the right displays most of these. We recommend that you contact one of our specialists to obtain samples for your specific needs, technical drawings or to help you with any other project.

The colors and finishes shown in the following pages may vary slightly from the actual colors and finishes.

LÉGENDE DE FINIS / FINISH LEGEND

CODE	FINI / COULEUR	FINISH / COLOR
AB	Laiton Antique	Antique Brass
AC	Cuivre Antique	Antique Copper
AI	Fer Antique	Antique Iron
ALU	Aluminium	Aluminum
ANT	Antique - Divers	Antique - Various
BAB	Laiton Antique Brossé	Brushed Antique Brass
BAC	Cuivre Antique Brossé	Brushed Antique Copper
BL	Noir	Black
BN	Nickel Noir	Black Nickel
BSB	Laiton Satiné Brossé	Brushed Satin Brass
BSC	Chrome Satiné Brossé	Brushed Satin Chrome
BSG	Or Satiné Brossé	Brushed Satin Gold
BSN	Nickel Satiné Brossé	Brushed Satin Nickel
BSS	Argent Satiné Brossé	Brushed Satin Silver
LAB	Laiton Antique Laqué	Lacquered Antique Brass
LCL	Charbon Laqué	Lacquered Charcoal
LMG	Or Mat Laqué	Lacquered Matte Gold
LMN	Nickel Mat Laqué	Lacquered Matte Nickel
LMS	Argent Mat Laqué	Lacquered Matte Silver
LQ	Bois Laqué	Lacquered Wood
MB	Noir Mat	Matte Black
MN	Nickel Mat	Matte Nickel
MOD	Moderne - Divers	Modern - Various
NLQ	Bois Non Laqué	Non Lacquered Wood
PB	Laiton Poli	Polished Brass
PC	Chrome Poli	Polished Chrome
PG	Or Poli	Polished Gold
SC	Chrome Satiné	Satin Chrome
SS	Acier Inoxydable	Stainless Steel
WH	Blanc	White

Contenu Poignées Q line ® Handles Contents

- 10 A 01 : Notes et Codes de couleurs / Notes & Color Codes
- 10 A 02 : Spécifications des produits / Product Specifications
- 10 AA 01 : Série 75700 & 75710 Series
- 10 AB 01 : Futura
- 10 AC 01 : Europa
- 10 AD 01 : Alumina
- 10 AE 01 : Duets
- 10 AF 01 : Recessed
- 10 AG 01 : Modern Classic
- 10 AH 01 : Colonial
- 10 AI 01 : Old Country
- 10 AJ 01 : Antica
- 10 AK 01 : Arbora
- 10 AQ 01 : Présentoir Q-50 / Q-50 Presentation Board
- 10 AQ 02 : Présentoir Q-100 / Q-100 Presentation Board
- 10 AR 01 : Poignées de porte / Door Handles
- 10 AS 01 : Hooks / Crochets

Données et dessins techniques disponibles à /
Technical drawings and specifications available at :

www.QLineHandles.com



Q line poignées / handles

Codes des produits / Product Codes

Poignées Q line [®] Handles								
Prod #	Page	Fini / Finishes	Collection	CC	Diam (ø)	Longueur / Length	Largeur / Width	Hauteur / Height
0734	10 AC 01	Toutes / All	Europa	-	24	-	-	-
0743	10 AF 01	Toutes / All	Recessed	-	-	47	47	12
0744	10 AF 01	Toutes / All	Recessed	-	-	115	42	12
1010B	10 AC 01	SS	Europa	64, 96, 128	-	98, 122, 170	-	20, 24, 27
1612B	10 AH 01	ANT	Colonial	70	-	102	44	29
1613B	10 AH 01	ANT	Colonial	84	-	102	21	19
1615B	10 AH 01	ANT	Colonial	-	-	32	32	25
1619B	10 AH 01	ANT	Colonial	32	-	76	32	22
1620B	10 AH 01	ANT	Colonial	-	32	-	-	29
1621B	10 AH 01	ANT	Colonial	128	-	154	51	25
1622B	10 AH 01	ANT	Colonial	51	-	102	44	29
1625B	10 AH 01	ANT	Colonial	-	32	-	-	29
1627B	10 AH 01	ANT	Colonial	-	30	-	-	26
1628B	10 AH 01	ANT	Colonial	-	32	-	-	30
1629B	10 AH 01	ANT	Colonial	-	33	-	-	22
2000B	10 AI 01	AI, MN	Old Country	76	-	86	13	25
2001B	10 AI 01	AI, MN	Old Country	-	35	-	-	25
2002B	10 AI 01	AI, MN	Old Country	-	-	32	-	32
2003B	10 AI 01	AI	Old Country	-	-	48	29	25
2004B	10 AI 01	AI	Old Country	76	-	114	6	41
2060B	10 AH 01	ANT	Colonial	76	-	117	14	25
2063B	10 AI 01	ANT	Old Country	-	35	-	-	30
2065B	10 AI 01	ANT	Old Country	96	-	148	11	35
2236B	10 AI 01	ANT	Old Country	76	-	114	9	19
2237B	10 AI 01	ANT	Old Country	-	-	32	32	29
2904B	10 AG 01	MOD, ANT	Modern Classic	-	-	41	25	27
2911B	10 AG 01	MOD, ANT	Modern Classic	76	-	128	10	25
2920B	10 AG 01	MOD, ANT	Modern Classic	-	30	-	-	27
2934B	10 AG 01	MOD, ANT	Modern Classic	96	-	110	14	27
2943B	10 AC 01	MOD, ANT	Europa	128	-	150	21	32
2945B	10 AF 03	MOD, ANT	Modern Classic	-	21	-	-	25
2953B	10 AC 01	MOD, ANT	Europa	64	-	130	29	25
2962B	10 AC 01	AL, BSN, PC	Europa	192	-	242	13	35
2963B	10 AC 01	AL, BSN, PC	Europa	160, 192	-	170, 202	21	25
2968B	10 AD 01	AL	Alumina	128, 160	-	152, 185	21	25
4991B	10 AH 01	MOD, ANT	Colonial	25	-	95	14	30
4998B	10 AH 01	MOD, ANT	Colonial	102	-	114	11	35
6000	10 AK 01	LQ, NLQ	Arbora	-	45	-	-	22
6001	10 AK 01	LQ, NLQ	Arbora	-	32	-	-	22
6002	10 AK 01	LQ, NLQ	Arbora	-	39	-	-	33
6003	10 AK 01	LQ, NLQ	Arbora	-	41	-	-	26
6004	10 AK 01	LQ, NLQ	Arbora	-	34	-	-	27
6005	10 AK 01	LQ, NLQ	Arbora	-	45	-	-	34
6006	10 AK 01	LQ, NLQ	Arbora	-	48	-	-	30
6007	10 AK 01	LQ, NLQ	Arbora	-	30	-	-	36
6008	10 AK 01	LQ, NLQ	Arbora	-	38	-	-	22
6009	10 AK 01	LQ, NLQ	Arbora	-	38	-	-	22
6010	10 AK 01	LQ, NLQ	Arbora	22	-	52	25	23
6011	10 AK 01	LQ, NLQ	Arbora	-	33	-	-	20
6012	10 AK 01	LQ, NLQ	Arbora	-	40	-	-	32
6013	10 AK 01	LQ, NLQ	Arbora	-	35	-	-	30
6016	10 AK 01	LQ, NLQ	Arbora	-	41	-	-	26
7002B	10 AG 01	MOD	Modern Classic	96	-	125	21	25
7003	10 AB 01	Toutes / All	Futura	-	-	24	-	-
7005	10 AC 01	Toutes / All	Europa	-	-	24	-	-
7011	10 AC 01	Toutes / All	Europa	-	-	36	23	27
7021	10 AB 01	Toutes / All	Futura	-	-	27, 34	-	28, 34

Q line poignées / handles

Codes des produits / Product Codes

Poignées Q line® Handles								
Prod #	Page	Fini / Finishes	Collection	CC	Diam (ø)	Longueur / Length	Largeur / Width	Hauteur / Height
7022	10 AC 01	Toutes / All	Europa	-	36	-	-	22
7023	10 AB 01	Toutes / All	Futura	-	-	39, 57	-	11, 18
7024	10 AJ 01	Toutes / All	Antica	-	24, 29	-	-	23, 28
7025	10 AJ 01	Toutes / All	Antica	-	31	-	55	15
7028	10 AJ 01	Toutes / All	Antica	-	-	125	-	20
7029	10 AE 01	Toutes / All	Duets	64, 96, 128	-	89, 122, 155	-	27, 29, 31
7030	10 AC 01	Toutes / All	Europa	96	-	104	-	30
7031	10 AE 01	Toutes / All	Duets	64, 96, 128	-	78, 110, 144	-	23, 24, 25
7032	10 AE 01	Toutes / All	Duets	-	-	77	-	24
7033	10 AE 01	Toutes / All	Duets	-	-	29, 35	-	19, 23
7035	10 AE 01	Toutes / All	Duets	-	-	22, 28	-	22, 23
7036	10 AE 01	Toutes / All	Duets	-	-	62	-	21
7038	10 AE 01	Toutes / All	Duets	64, 96, 128	-	101, 126, 168	-	20, 20, 24
7039	10 AE 01	Toutes / All	Duets	128	-	145	-	31
7040	10 AE 01	Toutes / All	Duets	64, 96	-	78, 112	-	22, 23
7041	10 AE 01	Toutes / All	Duets	96, 128	-	114, 152	-	27, 29
7044	10 AE 01	Toutes / All	Duets	64, 94	-	80, 116	-	25, 26
7045	10 AE 01	Toutes / All	Duets	64, 96, 128	-	83, 124, 160	-	19, 22, 22
7046	10 AE 01	Toutes / All	Duets	64, 96, 128	-	83, 124, 160	-	19, 22, 22
7047	10 AE 01	Toutes / All	Duets	96, 128, 160	-	118, 152, 182	-	28, 28, 30
7048	10 AD 01	Toutes / All	Alumina	96 - 480	-	106 - 490	-	38
7051	10 AE 01	Toutes / All	Duets	-	-	29	-	28
7054B	10 AG 01	MOD	Modern Classic	96	-	108	14	25
7061	10 AC 01	Toutes / All	Europa	-	14	-	-	25
7062B	10 AG 01	MOD	Modern Classic	-	32	-	25	25
7066	10 AB 01	Toutes / All	Futura	96, 128	-	110, 143	-	26, 27
7066B	10 AG 01	MOD	Modern Classic	96	-	137	16	27
7067	10 AC 01	Toutes / All	Europa	64, 96, 128	-	88, 123, 151	-	21, 25, 27
7069	10 AB 01	Toutes / All	Futura	-	-	28	-	24
70777	10 AH 01	Toutes / All	Colonial	96	-	130	-	24
7078B	10 AC 01	SS	Europa	-	30	-	-	32
7081B	10 AG 01	ANT, MOD	Modern Classic	96	-	111	13	30
7084B	10 AG 01	ANT, MOD	Modern Classic	128	-	162	14	29
7093B	10 AG 01	ANT, MOD	Modern Classic	-	35	-	-	29
7100	10 AB 01	Toutes / All	Futura	192	-	240	17	34
7101	10 AB 01	Toutes / All	Futura	128	-	144	-	26
7102	10 AB 01	Toutes / All	Futura	-	-	43	-	25
7103	10 AB 01	Toutes / All	Futura	-	-	18, 24	-	22, 23
7104	10 AF 01	Toutes / All	Recessed	-	40.5	-	-	11
7105	10 AB 01	Toutes / All	Futura	-	-	43	-	27
7106	10 AB 01	Toutes / All	Futura	128	-	140	-	29
7112	10 AB 01	Toutes / All	Futura	16	-	25	25	21
7129	10 AC 01	Toutes / All	Europa	-	30	30	19	30
72035	10 AC 01	Toutes / All	Europa	64, 96	-	81, 111	-	21, 22
72043	10 AC 01	Toutes / All	Europa	96, 96, 128	10	115, 118, 152	-	24, 29, 31
72050	10 AC 01	Toutes / All	Europa	96, 96, 128	8	111, 114, 148	-	24, 29, 31
72051	10 AE 01	Toutes / All	Duets	-	-	29, 35	-	21, 23
72052	10 AE 01	Toutes / All	Duets	-	20, 24	-	-	20, 23
72257	10 AG 01	Toutes / All	Modern Classic	96	-	112	-	23
72277	10 AC 01	Toutes / All	Europa	128	-	140	-	26
72320	10 AC 02	Toutes / All	Europa	64, 96, 128	-	102, 144, 176	-	25, 29, 32
72352	10 AC 02	Toutes / All	Europa	64, 96, 128	-	85, 121, 155	-	25, 25, 28
72360	10 AC 02	Toutes / All	Europa	-	28, 33	-	-	24, 27
72376	10 AC 02	Toutes / All	Europa	96	-	172	-	17
72385	10 AH 01	Toutes / All	Colonial	-	29	-	-	24
72476	10 AG 01	Toutes / All	Modern Classic	-	30	-	-	23
72607	10 AH 01	Toutes / All	Colonial	-	25	-	-	20

Q line poignées / handles

Codes des produits / Product Codes

Poignées Q line® Handles								
Prod #	Page	Fini / Finishes	Collection	CC	Diam (ø)	Longueur / Length	Largeur / Width	Hauteur / Height
734P	10 AC 01	Toutes / All	Europa	-	24	-	-	-
7501	10 AC 01	Toutes / All	Europa	128, 160, 192	-	162, 192, 227	-	26, 26, 28
7502	10 AC 02	Toutes / All	Europa	64 - 240	-	87 - 273	-	25 - 27
7503	10 AC 02	Toutes / All	Europa	128, 160	-	160, 192	-	27, 30
7504	10 AC 02	Toutes / All	Europa	128, 160	-	140, 171	-	33, 33
7505	10 AC 02	Toutes / All	Europa	96, 128, 160	-	115, 150, 184	-	26, 29, 30
7506	10 AC 02	Toutes / All	Europa	64, 96, 128, 160	-	78, 111, 145, 178	-	22, 22, 23, 25
7507	10 AC 02	Toutes / All	Europa	96, 128, 160	-	126, 158, 194	-	27, 31, 31
7508	10 AC 02	Toutes / All	Europa	160	-	223	-	30
7509	10 AC 02	Toutes / All	Europa	128, 160	-	166, 202	-	30, 30
7510	10 AB 01	Toutes / All	Futura	128	-	149	-	30
7511	10 AC 02	Toutes / All	Europa	64, 96, 128, 160	-	71, 103, 136, 168	-	26, 26, 31, 31
7512	10 AC 02	Toutes / All	Europa	64, 96, 128, 160	-	106, 157, 200, 240	-	23, 23, 26, 28
7513	10 AC 02	Toutes / All	Europa	224	-	245	15	29
7514	10 AG 01	Toutes / All	Modern Classic	128	-	158	-	30
7515	10 AG 01	Toutes / All	Modern Classic	64, 96, 128, 160	-	75, 108, 140, 171	-	27, 28, 28, 30
7516	10 AC 02	Toutes / All	Europa	128	-	162, 191	-	29, 30
7517	10 AC 02	Toutes / All	Europa	128	-	126, 166	-	28, 30
7518	10 AC 03	Toutes / All	Europa	128	-	150	-	29
7519	10 AC 03	Toutes / All	Europa	64, 128, 160	-	86, 118, 150	-	34, 34, 34
7520	10 AG 01	Toutes / All	Modern Classic	64, 96, 128, 160	-	74, 108, 142, 170	-	29, 29, 29, 29
7521	10 AG 01	Toutes / All	Modern Classic	96, 128, 160	-	106, 141, 176	-	22, 25, 31
7522	10 AC 03	Toutes / All	Europa	96, 128	-	140, 184	-	24, 25
7524	10 AB 01	Toutes / All	Futura	96, 128	-	113, 180	9, 10	24, 27
7525	10 AD 01	AL	Alumina	32 - 500	-	56 - 524	-	20
7526	10 AD 01	AL	Alumina	32 - 500	-	56 - 524	-	22
7527	10 AD 01	AL	Alumina	32 - 500	-	56 - 524	-	18
7528	10 AD 01	AL	Alumina	32 - 500	-	56 - 524	-	17
7529	10 AD 01	AL	Alumina	32 - 500	-	56 - 524	-	19.5
7530	10 AD 01	AL	Alumina	32 - 500	-	56 - 524	-	19.5
7531	10 AD 01	AL	Alumina	32 - 500	-	56 - 524	-	-
7532	10 AD 01	Toutes / All	Alumina	96 - 480	-	136 - 520	-	28
7533	10 AD 01	Toutes / All	Alumina	96 - 480	-	116 - 504	-	30
7534	10 AD 01	Toutes / All	Alumina	96 - 480	-	116 - 504	-	28
7535	10 AD 01	Toutes / All	Alumina	96 - 480	-	106 - 490	-	28
7536	10 AD 01	Toutes / All	Alumina	96 - 480	-	116 - 500	-	31
7537	10 AD 01	Toutes / All	Alumina	96 - 480	-	120 - 504	-	32
7538	10 AB 01	Toutes / All	Futura	96, 128, 160	-	128, 160, 192	-	-
7539	10 AB 01	Toutes / All	Futura	96, 128, 160	-	128, 160, 192	-	20.5
7540	10 AD 01	AL	Alumina	96 - 480	-	120 - 504	-	41
7541	10 AD 01	AL	Alumina	128	-	145	-	28
7542	10 AE 01	Toutes / All	Duets	96, 128, 160	-	114, 145, 177	-	25, 27, 27
7543	10 AE 02	Toutes / All	Duets	64, 96, 128	-	91, 124, 155	-	28, 28, 28
7544	10 AE 02	Toutes / All	Duets	32, 64, 96, 128	-	43, 75, 108, 140	-	19, 27, 28, 31
7545	10 AE 02	Toutes / All	Duets	64, 96, 128	-	77, 112, 149	-	22, 28, 28
7546	10 AE 02	Toutes / All	Duets	64, 96, 128	-	89, 103, 147	-	26, 28, 28
7547	10 AE 02	Toutes / All	Duets	64, 96, 128	-	81, 124, 162	-	22, 23, 26
7548	10 AG 02	Toutes / All	Modern Classic	96	-	128	-	21
7549	10 AE 02	Toutes / All	Duets	96	-	128	-	21
7550	10 AE 02	Toutes / All	Duets	96, 128	-	102, 134	-	26, 28
7551	10 AC 03	Toutes / All	Europa	64, 96, 128	-	97, 144, 184	-	21, 25, 27
7552	10 AC 03	Toutes / All	Europa	96, 128	-	127, 160	-	23, 23
7553	10 AC 03	Toutes / All	Europa	128	-	173	-	26
7554	10 AG 02	Toutes / All	Modern Classic	64, 96, 128	-	98, 122, 170	-	20, 24, 27
7555	10 AG 02	Toutes / All	Modern Classic	64, 96, 128	-	86, 119, 154	-	24, 25, 25
7556	10 AG 02	Toutes / All	Modern Classic	96	-	115	-	29
7558	10 AG 02	Toutes / All	Modern Classic	96, 128	-	118, 153	-	23, 26

Q line poignées / handles

Codes des produits / Product Codes

Poignées Q line® Handles								
Prod #	Page	Fini / Finishes	Collection	CC	Diam (ø)	Longueur / Length	Largeur / Width	Hauteur / Height
7559	10 AG 02	Toutes / All	Modern Classic	96, 128	-	109, 144	-	28, 33
7560	10 AC 03	Toutes / All	Europa	64, 96	-	90, 133	-	23, 30
7561	10 AB 01	Toutes / All	Futura	64, 96	-	89, 124	-	23, 27
7562	10 AC 03	Toutes / All	Europa	96, 128	-	113, 145	-	26, 26
7563	10 AB 01	Toutes / All	Futura	64, 96	-	72, 106	-	22, 26
7565	10 AB 02	Toutes / All	Futura	64, 96	-	90, 120	-	26, 33
7566	10 AC 03	Toutes / All	Europa	96, 128	-	127, 159	-	23, 29, 27
7567	10 AC 03	Toutes / All	Europa	96, 128	-	114, 153	-	27, 27
7568	10 AG 02	Toutes / All	Modern Classic	64, 96, 128	-	80, 113, 148	-	-
7569	10 AJ 01	Toutes / All	Antica	60	-	-	-	85
7570	10 AJ 01	Toutes / All	Antica	-	31, 37, 45	6, 8, 10	-	-
75700	10 AA 01	Toutes / All	75700	64 - 720	12	115 - 800	-	D + 22
7571	10 AJ 01	Toutes / All	Antica	-	20	58	-	-
75710	10 AA 01	Toutes / All	75700	64 - 720	10	115 - 800	-	D + 18
7572	10 AJ 01	Toutes / All	Antica	64	-	94	-	38
7573	10 AJ 01	Toutes / All	Antica	-	34	29	17	-
7574	10 AJ 01	Toutes / All	Antica	-	-	50	-	32
7575	10 AJ 01	Toutes / All	Antica	-	23	79	-	-
7576	10 AJ 01	Toutes / All	Antica	-	36.5	172	-	-
7577	10 AJ 01	Toutes / All	Antica	69	-	81	-	68
7578	10 AJ 01	Toutes / All	Antica	96	30	128	-	40
7579	10 AF 01	Toutes / All	Recessed	-	-	92	-	14
7580	10 AF 01	Toutes / All	Recessed	64, 96, 128	-	77, 107, 141	-	12, 12, 12
7581	10 AF 01	Toutes / All	Recessed	72, 106	-	110, 152	-	12, 12
7582	10 AF 01	Toutes / All	Recessed	64, 128	-	102, 141	-	13, 13
7583	10 AF 01	Toutes / All	Recessed	-	-	-	-	-
7584	10 AF 01	Toutes / All	Recessed	-	-	60	47	-
7585	10 AF 01	Toutes / All	Recessed	-	-	124	-	13
7586	10 AF 01	Toutes / All	Recessed	-	-	128	-	13
7588	10 AC 03	Toutes / All	Europa	64, 96, 128	-	88, 170, 200	-	15, 20, 20
7590	10 AB 02	Toutes / All	Futura	-	18 - 29	23 - 38	-	-
7591	10 AB 02	Toutes / All	Futura	-	17	-	-	28
7592	10 AB 02	Toutes / All	Futura	-	-	20	-	30
7594	10 AB 02	Toutes / All	Futura	-	18, 20, 25	-	-	26, 26, 28
7595	10 AB 02	Toutes / All	Futura	-	20	-	-	25
7596	10 AG 02	Toutes / All	Modern Classic	-	24, 30	-	-	21, 26
7597	10 AG 02	Toutes / All	Modern Classic	25	24	-	-	24
7598	10 AB 02	Toutes / All	Futura	-	24, 27	-	-	28, 32
7599	10 AB 02	Toutes / All	Futura	-	-	43	-	18
7600	10 AB 02	Toutes / All	Futura	-	24	-	-	24
7602	10 AB 02	Toutes / All	Futura	-	18 - 28	-	-	26 - 38
7603	10 AB 02	Toutes / All	Futura	-	-	29	-	18
7604	10 AB 02	Toutes / All	Futura	24	-	45	-	16
7607	10 AB 02	Toutes / All	Futura	32, 64	-	40	-	19
7608	10 AB 02	Toutes / All	Futura	-	-	40	40	-
7609	10 AB 02	Toutes / All	Futura	-	-	34	23	-
7610	10 AG 02	Toutes / All	Modern Classic	-	27	-	-	24
7611	10 AB 02	Toutes / All	Futura	-	-	44	-	23
7612	10 AB 02	Toutes / All	Futura	-	-	49	-	24
7613	10 AB 02	Toutes / All	Futura	-	-	21	-	25
7614	10 AB 03	Toutes / All	Futura	-	-	64	-	23
7615	10 AE 02	Toutes / All	Duets	-	30	-	-	28
7616	10 AH 01	Toutes / All	Colonial	-	27	-	-	33
7617	10 AB 03	Toutes / All	Futura	-	-	29	-	18
7618	10 AB 03	Toutes / All	Futura	-	-	44	-	23
7619	10 AB 03	Toutes / All	Futura	-	-	40	-	40
7620	10 AB 03	Toutes / All	Futura	-	11, 25	-	-	8, 23

Q line poignées / handles

Codes des produits / Product Codes

Poignées Q line® Handles								
Prod #	Page	Fini / Finishes	Collection	CC	Diam (ø)	Longueur / Length	Largeur / Width	Hauteur / Height
7621	10 AB 03	Toutes / All	Futura	-	-	33	-	20
7622	10 AB 03	Toutes / All	Futura	-	-	32	-	22
7623	10 AB 03	Toutes / All	Futura	-	-	33	-	22
7624	10 AB 03	Toutes / All	Futura	-	-	52	-	24
7625	10 AB 03	Toutes / All	Futura	-	-	45	-	22
7626	10 AB 03	Toutes / All	Futura	-	-	36, 47	-	26, 38
7627	10 AB 03	Toutes / All	Futura	-	-	26, 36	-	22, 26
7628	10 AB 03	Toutes / All	Futura	-	-	24	-	25
7629	10 AB 03	Toutes / All	Futura	-	-	25	25	-
7630	10 AB 03	Toutes / All	Futura	-	-	40	-	27
7631	10 AB 03	Toutes / All	Futura	-	-	30	-	20
7650	10 AC 03	Toutes / All	Europa	128, 160	-	167, 199	-	28, 28
7740	10 AG 02	Toutes / All	Modern Classic	64 - 608	8, 10, 12	74 - 618	-	-
7759	10 AG 02	Toutes / All	Modern Classic	96	-	108	-	19
7950	10 AR 01	SS	Porte / Door	170	-	200	100	-
7951	10 AR 01	SS	Porte / Door	210	-	244	58	-
7952	10 AR 01	SS	Porte / Door	L-25	19, 25	200, 300, 400	-	70, 70, 70
7953	10 AR 01	SS	Porte / Door	350	-	395	61	-
7954	10 AR 01	SS	Porte / Door	350	-	395	65	-
7955	10 AR 01	SS	Porte / Door	176	-	244	64	-
7956	10 AR 01	SS	Porte / Door	210	-	249	-	-
7957	10 AR 01	SS	Porte / Door	215	-	240	12	-
7958	10 AR 02	SS	Porte / Door	170	-	200	105	-
7959	10 AR 02	SS	Porte / Door	224	-	230	92	-
7960	10 AR 02	SS	Porte / Door	155	-	191	79	58
7961	10 AR 02	SS	Porte / Door	165	-	195	88	55
7962	10 AR 02	SS	Porte / Door	96	-	112	85	58
7963	10 AR 02	SS	Porte / Door	95	-	113	88	58
7964	10 AR 02	SS	Porte / Door	120	-	144	85	59
7965	10 AR 02	SS	Porte / Door	105	-	104	92	58
9312B	10 AG 02	PB	Modern Classic	-	32	-	-	24
9713B	10 AG 02	ANT, MOD	Modern Classic	64	-	78	29	24
9721B	10 AG 02	ANT, MOD	Modern Classic	96	-	133	16	24
9860B	10 AI 01	ANT	Old Country	76	-	87	14	16
9861/62B	10 AI 01	ANT	Old Country	-	38	41	41	10
9862/70B	10 AI 01	ANT	Old Country	-	-	51	13	13
9863B	10 AI 01	ANT	Old Country	-	37	-	35	22
9864B	10 AI 01	ANT	Old Country	111	-	149	54	19
9865/66B	10 AI 01	ANT	Old Country	-	-	51	44	16
9867B	10 AI 01	ANT	Old Country	-	35	-	35	25
9873B	10 AI 01	ANT	Old Country	76	-	121	22	22
9874B	10 AI 01	ANT	Old Country	-	35	-	35	25
9875B	10 AI 01	ANT	Old Country	108	-	128	22	21
9878B	10 AH 02	ANT	Colonial	-	25	-	-	21
9879B	10 AH 02	ANT	Colonial	32	-	76	32	22
9880B	10 AH 02	ANT	Colonial	-	35	-	-	25
9893B	10 AH 02	ANT, MOD	Colonial	76	-	120	37	24
9925B	10 AH 02	ANT, MOD	Colonial	-	29	-	-	25
9935B	10 AH 02	ANT, MOD	Colonial	-	-	33	22	32
9941B	10 AH 02	ANT, MOD	Colonial	-	32	-	-	26

Les spécifications susmentionnées sont nominales et servent de guide seulement. Elles peuvent changer à tout moment sans préavis.

Pour des détails précis et à jour sur un produit en particulier, veuillez contacter un de nos représentants.

The specifications above are for guidance only. They are subject to change without prior notice.

For precise and updated details on a specific product, please contact one of our representatives.

Q line poignées / handles

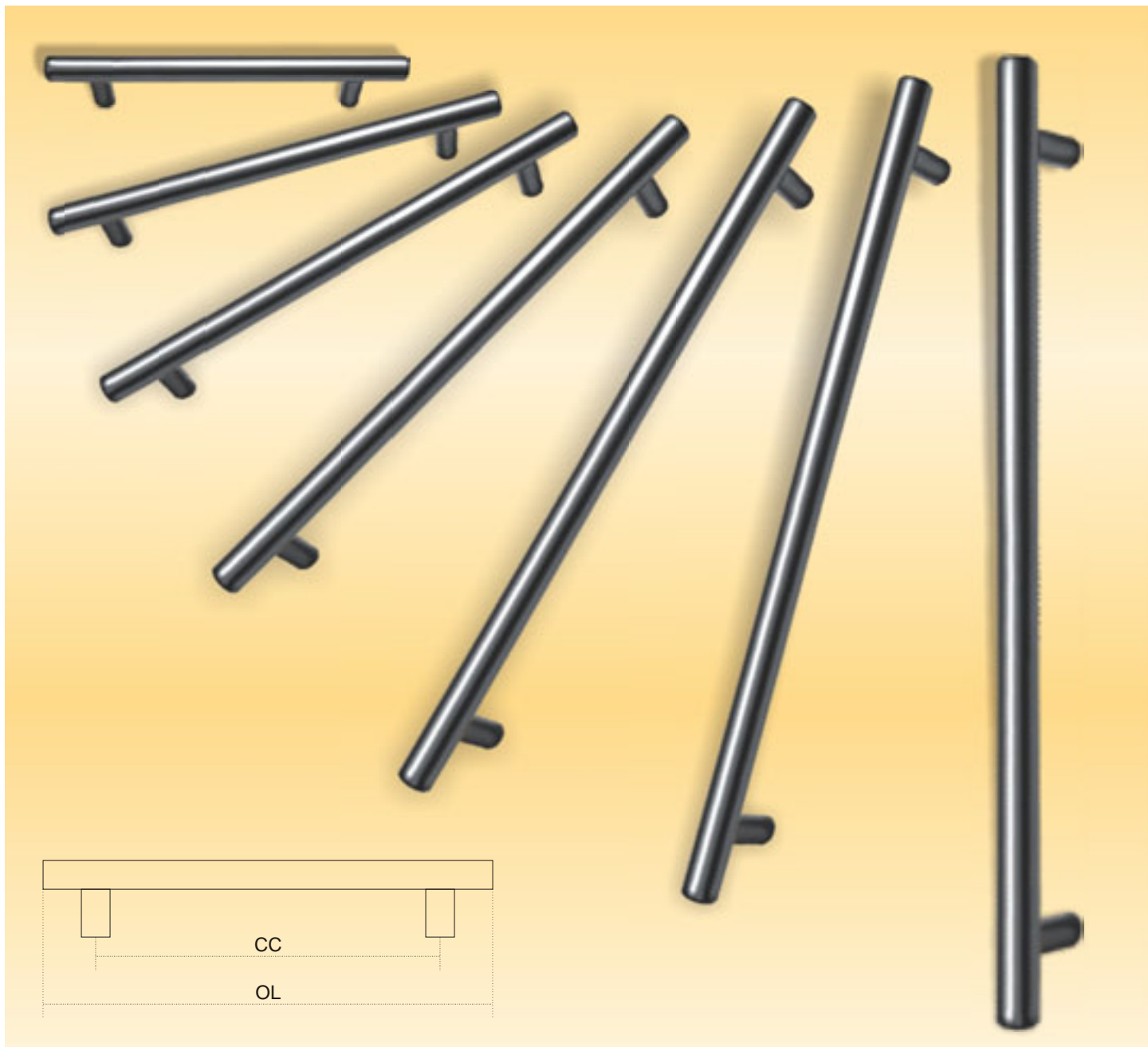
Série 75700 & 75710 Series

Série 75700 Series : \varnothing 12 mm • Série 75710 Series : \varnothing 10 mm

OL	CC
150	96
188	128
250	160

OL	CC
252	192
284	224
380	320

OL	CC
444	384
508	448
636	576

OL	CC
796	736
920	860

Q line poignées / handles

Futura



7003



7021



7023



7066

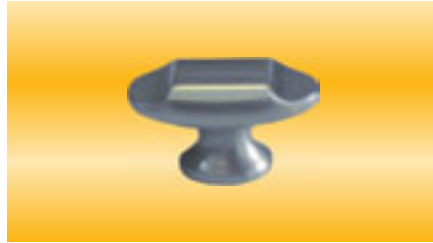

7069



7100

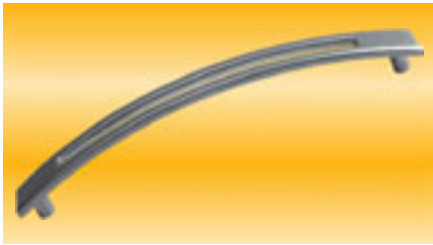

7101

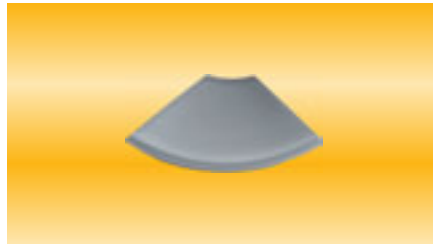

7102

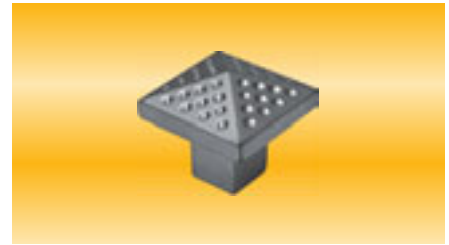

7103



7105



7106



7112



7510



7524



7538



7539



7561



7563

Q line poignées / handles

Futura



7565

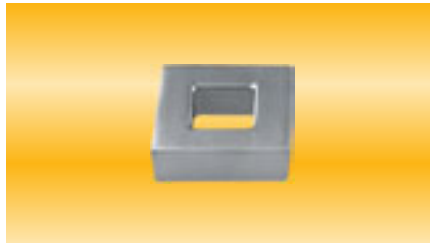

7590



7591



7592



7594



7595



7598



7599



7600



7602



7603

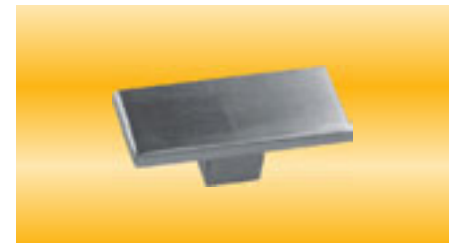

7604



7607



7608



7609



7611



7612



7613

Q line poignées / handles

Futura

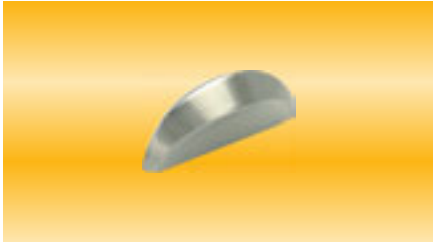

7614



7617



7618



7619



7620



7621



7622



7623

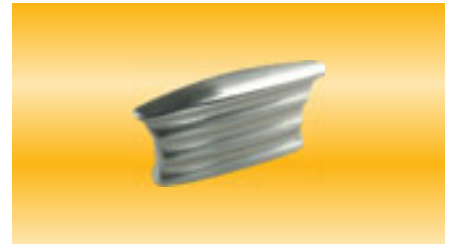

7624



7625



7626



7627



7628



7629



7630



7631

Q line poignées / handles

Europa



0734



734P



1010B



2943B



2953B



2962B



2963B



7005



7011



7022



7030



7061



7067



7078B



7129



72035



72043 & 72050



72277

Q line poignées / handles

Europa



72320



72352



72360



72376



7501



7502

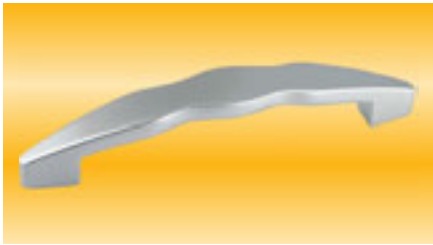

7503

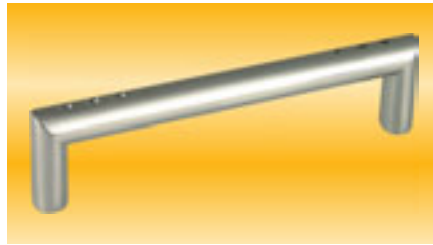

7504



7505



7506



7507



7508



7509



7511



7512



7513



7516



7517

Q line poignées / handles

Europa

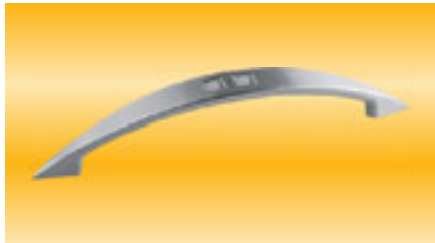

7518



7519



7522



7551



7552



7553



7560



7562



7566



7567



7588



7650

Q line poignées / handles

Alumina

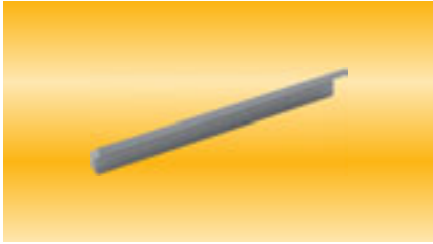

2968B



7048

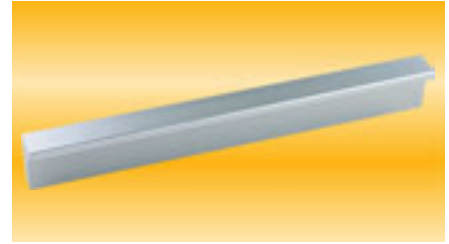

7525

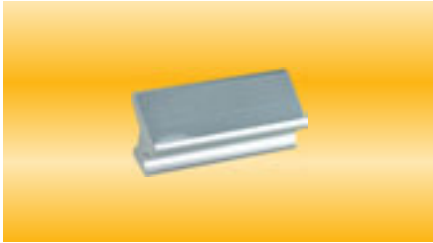

7526



7527

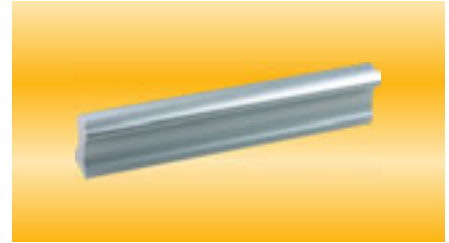

7528

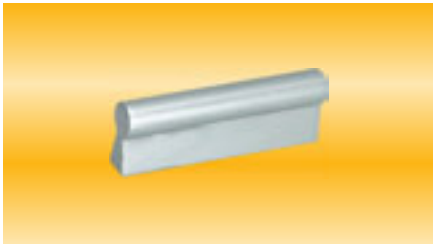

7529



7530



7531



7532



7533



7534



7535



7536



7537



7540



7541

Q line poignées / handles

Duets



7029



7031



7032



7033



7035



7036



7038



7039



7040



7041



7044



7045



7046



7047



7051



72051



72052



7542

Q line poignées / handles

Duets

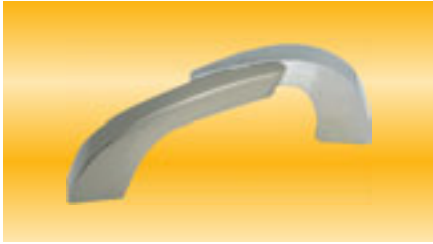

7543

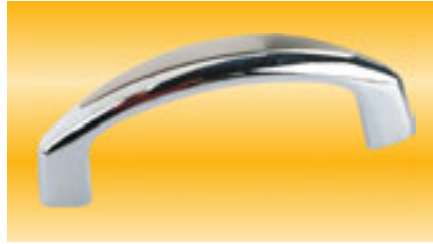

7544



7545



7546



7547



7549

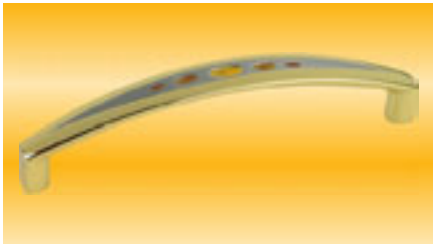

7550



7615

Q line poignées / handles

Recessed



0743



0744



7104

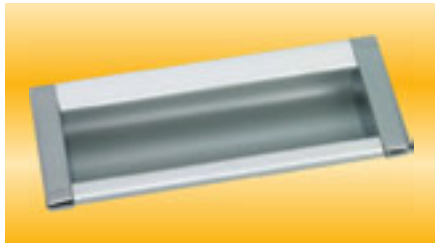

7579

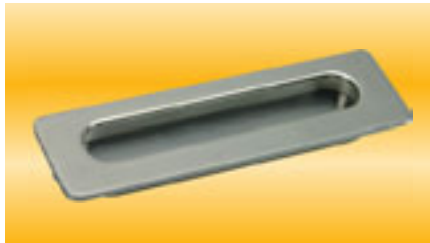

7580

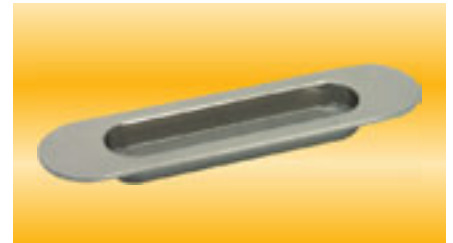

7581



7582



7583

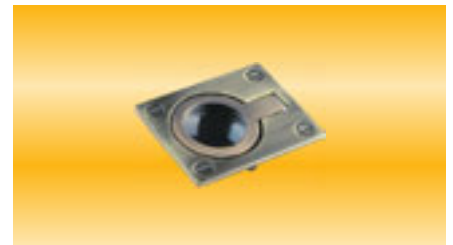

7584



7585



7586

Q line poignées / handles

Modern Classic



2904B



2911B



2920B



2934B



2945B



7002B



7054B



7062B



7066B



7081B



7084B



7093B



72257



72476



7514



7515



7520



7521

Q line poignées / handles

Modern Classic



7548



7554



7555



7556



7558



7559



7568



7596



7597



7610



7740



7759



9712B



9713B



9721B

Qline poignées / handles

Colonial



1612B



1613B



1615B



1619B



1620B



1621B



1622B



1625B



1627B



1628B



1629B



2060B



4991B



4998B



70777



72385



72607



7616

Q line poignées / handles

Colonial

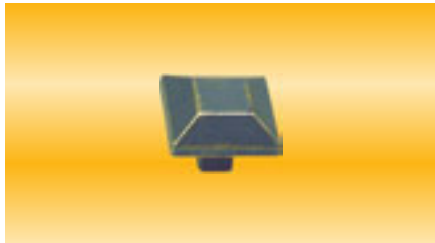

9878B



9879B



9880B



9893B



9925B



9935B



9941B

Q line poignées / handles

Old Country



2000B



2001B



2003B



2004B

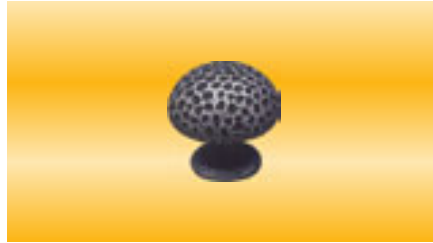

2063B



2065B



2236B

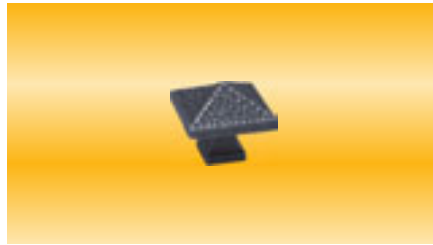

2237B



9860B



9861/62B



9862/70B



9863B



9864B



9865/66B



9867B



9873B



9874B



9875B

Q line poignées / handles

Antica



7024



7025



7028



7569



7570



7571



7572



7573



7574



7575



7576



7577



7578

Q line poignées / handles

Arbora



6000



6001



6002



6003



6004



6005



6006



6007



6008



6009



6010



6011



6012



6013



6016

Qline poignées / handles

Présentoir Q-50 Presentation Board

- 1 - 0734BAB832/31
- 2 - 0734BAC832/31
- 3 - 0734BN832/31
- 4 - 0734BSB832/31
- 5 - 0734BSN832/31
- 6 - 0734PB832/31
- 7 - 0734PC832/31
- 8 - 0734SC832/31
- 9 - 0754PB832/96
- 10 - 0754PC832/96
- 11 - 0754SC832/96
- 12 - 7011SC832/36
- 13 - 7025ABM4
- 14 - 7028ABM4
- 15 - 7030BSNM4/96
- 16 - 70777PB832/76
- 17 - 7100SCM4/96
- 18 - 7102MNM4/45
- 19 - 7129BSNM4/JSS
- 20 - 72043BNM4/96
- 21 - 72043BSNM4/96
- 22 - 72050 MN M4/96
- 23 - 72052PCWHM4/L
- 24 - 72385ABM4/28
- 25 - 72385AIM4/28

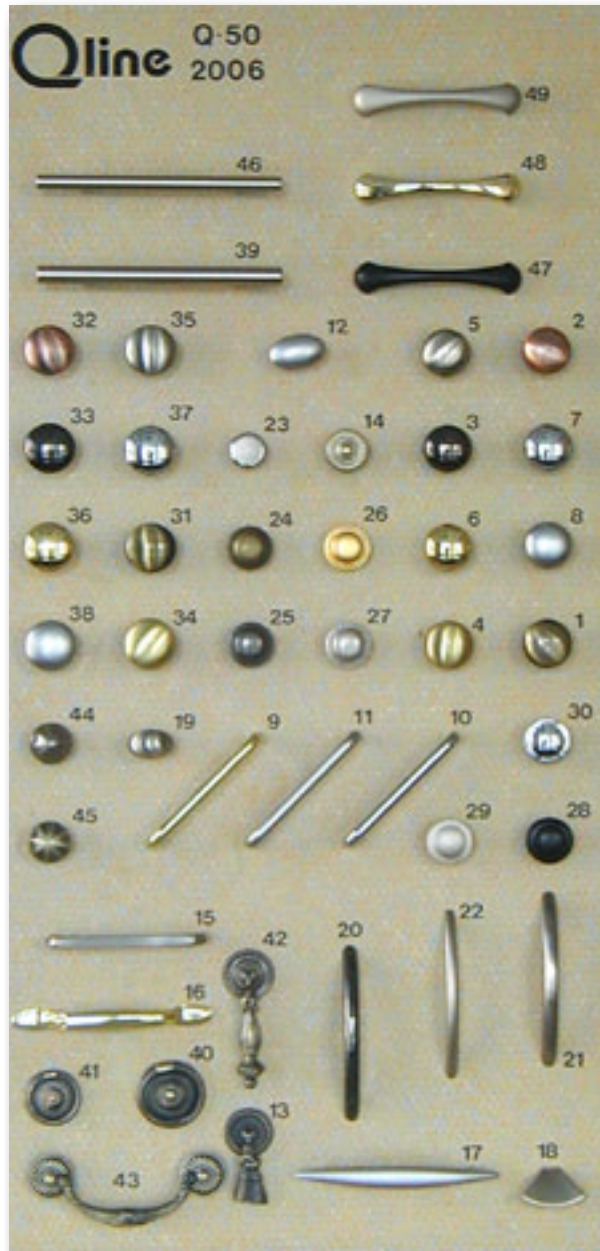

- 26 - 72385GM4/28
- 27 - 72385LMNM4/28
- 28 - 72476MB832/28
- 29 - 72476MNM4/28
- 30 - 72476PCM4/28
- 31 - 734PBAB832/31
- 32 - 734PBAC832/31
- 33 - 734PBN832/31
- 34 - 734PBSB832/31
- 35 - 734PBSN832/31
- 36 - 734PFB832/31
- 37 - 734PPC832/31
- 38 - 734PSC832/31
- 39 - 75700BSNM4/96
- 40 - 7570ABM4/L
- 41 - 7570ABM4/M
- 42 - 7573ABM4/L
- 43 - 7578ABM4/96
- 44 - 7616ABM4
- 45 - 7616AIM4
- 46 - 75710BSNM4/96
- 47 - P7759MBM4/96
- 48 - P7759MNM4/96
- 49 - P7759FBM4/96

Ce présentoir peut différer sensiblement des présentoirs actuels.
Actual boards may be slightly different than the one above.

Qline poignées / handles

Présentoir Q-100 Presentation Board

- 1 - 0734BAB832/31
- 2 - 0734BAC832/31
- 3 - 0734BN832/31
- 4 - 0734BSB832/31
- 5 - 0734BSN832/31
- 6 - 0734PB832/31
- 7 - 0734PC832/31
- 8 - 0734SC832/31
- 9 - 0754PB832/96
- 10 - 1610-1RBG-B
- 11 - 1611-1RBG-B
- 12 - 1614-1RBG-B
- 13 - 1615-1RBG-B
- 14 - 1616-1RBG-B
- 15 - 1617-1RBG-B
- 16 - 1618-1RBG-B
- 17 - 1619-1RBG-B
- 18 - 1621-1AG-B
- 19 - 1623-1AG-B
- 20 - 1625-1AG-B
- 21 - 1629-1AG-B
- 22 - 2054-155-P
- 23 - 2056-155-P
- 24 - 2057-1FE-P
- 25 - 2058-1FB-P
- 26 - 2060-1FB-P
- 27 - 2061-1AP-P
- 28 - 2491-315-P
- 29 - 2920-1BPN-P
- 30 - 2927-155-P
- 31 - 2930-1BPN-P
- 32 - 2931-1BBN-P
- 33 - 2937-155-P
- 34 - 4992-3BAC-P
- 35 - 4996-3BAC-P
- 36 - 6932-115-C
- 37 - 7011SC832/36
- 38 - 7024ABM4/L
- 39 - 7025ABM4
- 40 - 7028ABM4
- 41 - 7030BSNM4/96
- 42 - 7064-107-C
- 43 - 7093-1BPN-C
- 44 - 7100-115-C
- 45 - 7100SCM4/96
- 46 - 7101SC832/128
- 47 - 7102MNM4/45
- 48 - 7129BSNM4/30
- 49 - 72043BNM4/96
- 50 - 72043BSNM4/96
- 51 - 72050MNM4/96



- 52 - 72052PCWHM4/L
- 53 - 72385ABM4/28
- 54 - 72385AIM4/28
- 55 - 72385MGM4/28
- 56 - 72385LMNM4/28
- 57 - 72476MB832/28
- 58 - 72476MNM4/28
- 59 - 72476PCM4/28
- 60 - 734PBAB832/31
- 61 - 734PBAC832/31
- 62 - 734PBN832/31
- 63 - 734PBSB832/31
- 64 - 734PBSN832/31
- 65 - 734PPB832/31
- 66 - 734PPC832/31
- 67 - 734PSC832/31
- 68 - 7569ABM4/60
- 69 - 75700BSNM4/128
- 70 - 75700BSNM4/160
- 71 - 75700BSNM4/192
- 72 - 75700BSNM4/224
- 73 - 75700BSNM4/320
- 74 - 75700BSNM4/384
- 75 - 75700BSNM4/448
- 76 - 75700BSNM4/576
- 77 - 75700BSNM4/736
- 78 - 75700BSNM4/860
- 79 - 75700BSNM4/96
- 80 - 7570ABM4/L
- 81 - 7570ABM4/M
- 82 - 75710BSNM4/96
- 83 - 7573ABM4/L
- 84 - 7578ABM4/96
- 85 - 7616ABM4
- 86 - 7616AIM4
- 87 - 7740PC10M4/160
- 88 - 7740SC8M4/96
- 89 - 9719-1BAC-P
- 90 - 9722-1BAC-P
- 91 - 9874-1CT-B
- 92 - 9879-1RB-B
- 93 - 9880-1RB-B
- 94 - 9881-1RB-B
- 95 - 9882-1RP-B
- 96 - 9883-1RP-B
- 97 - 9889-1WC-P
- 98 - 99602AP-P
- 99 - 9966-2AP-P
- 100 - P7759MBM4/96
- 101 - P7759MNM4/96
- 102 - P7759PBM4/96

Ce présentoir peut différer sensiblement des présentoirs actuels.
Actual boards may be slightly different than the one above.

Q line poignées / handles

Poignées de portes / *Door handles*

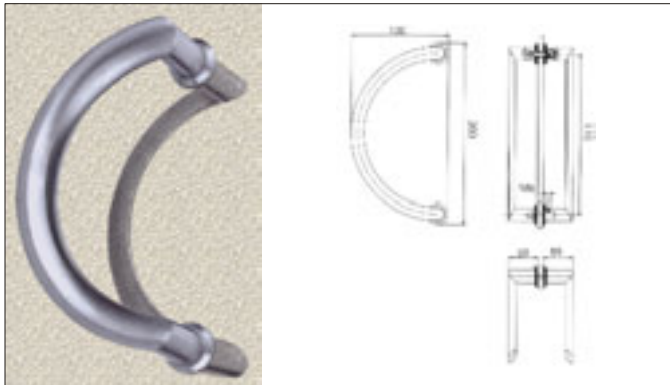

7950

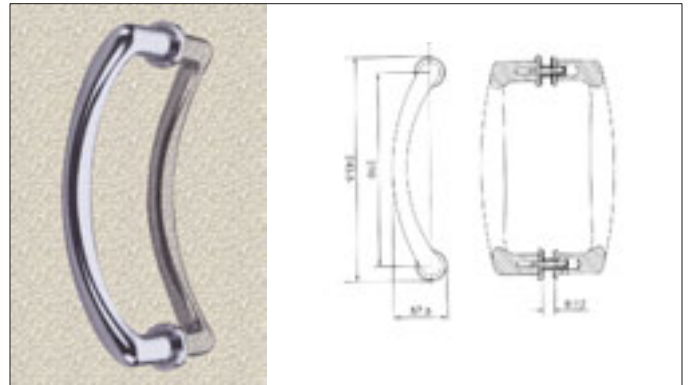

7951

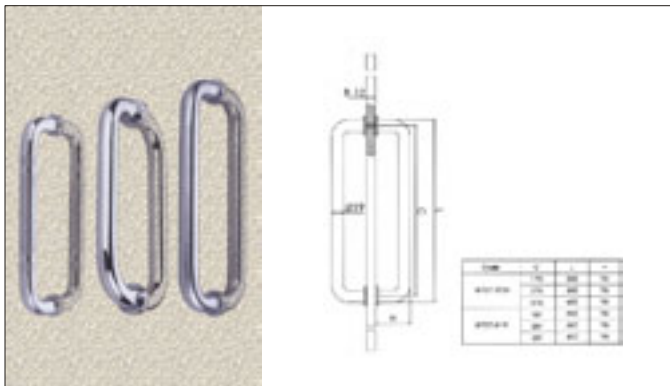

7952

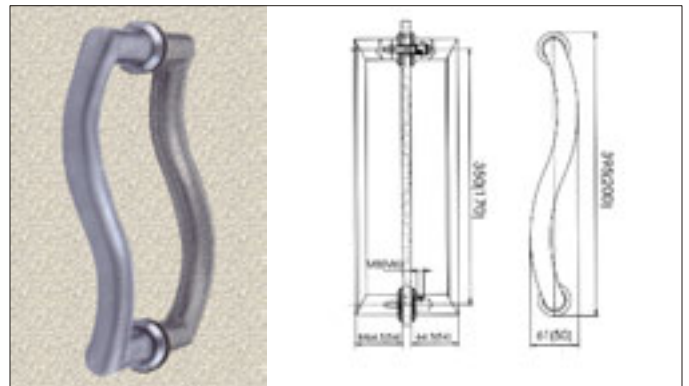

7953

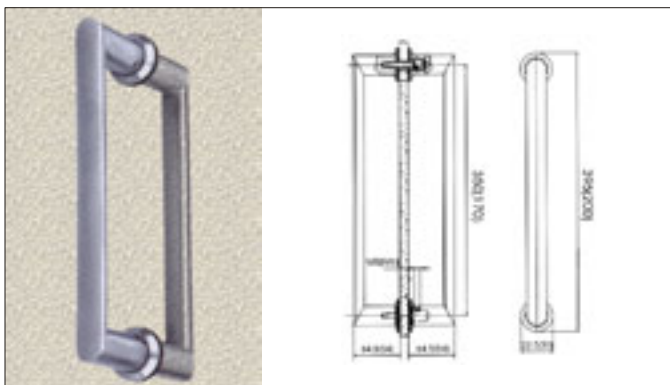

7954

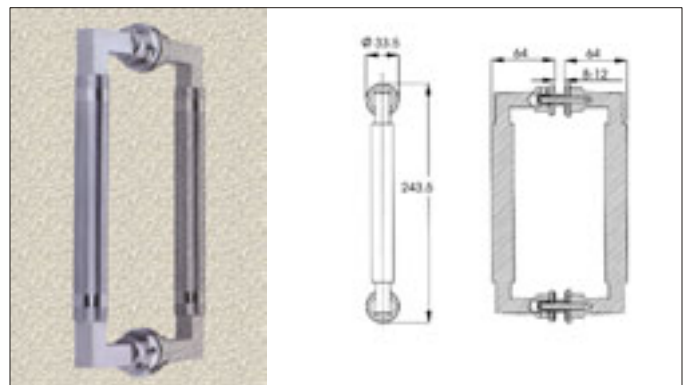

7955

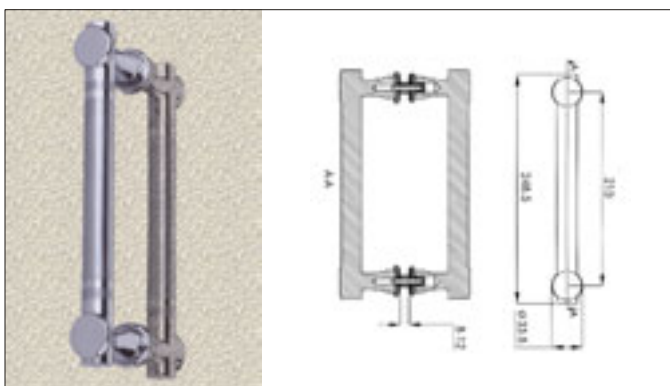

7956

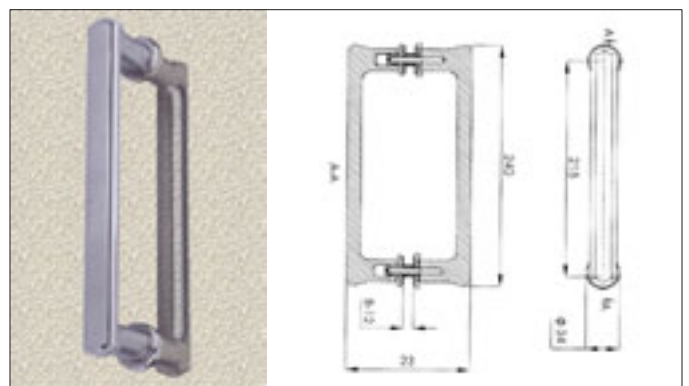

7957

Q line poignées / handles

Poignées de portes / *Door handles*

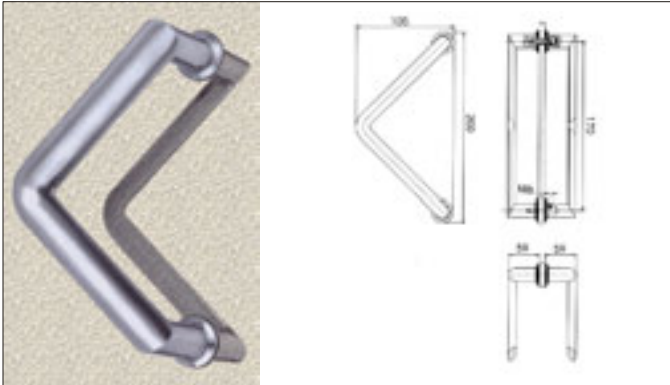

7958

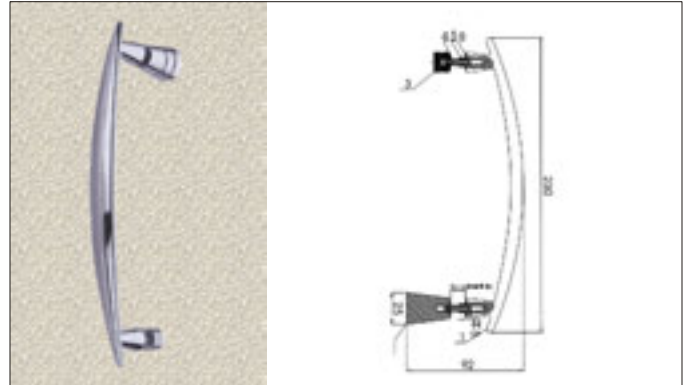

7959

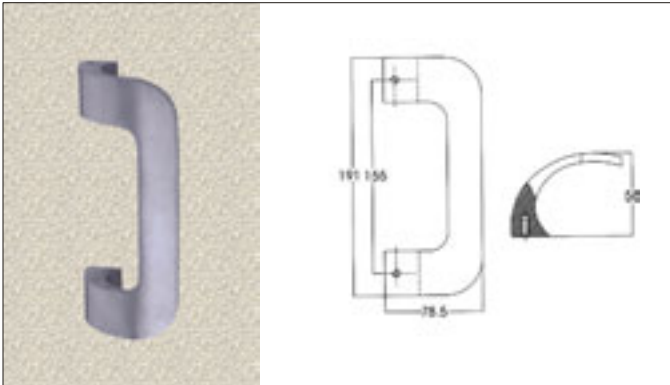

7960

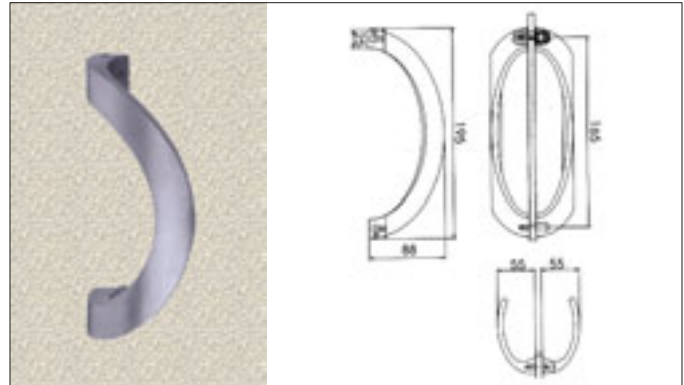

7961

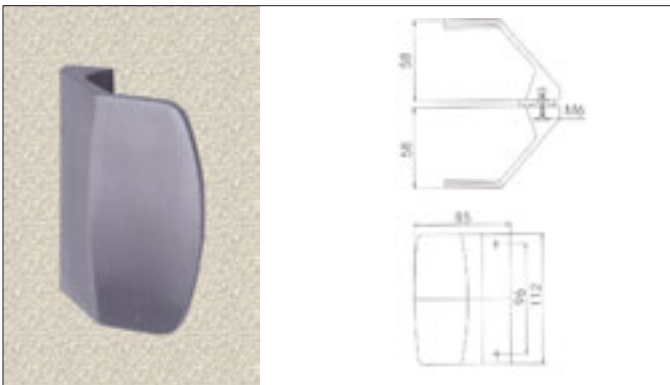

7962

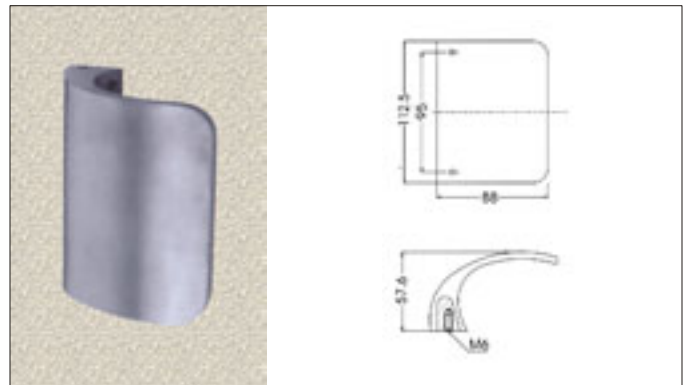

7963

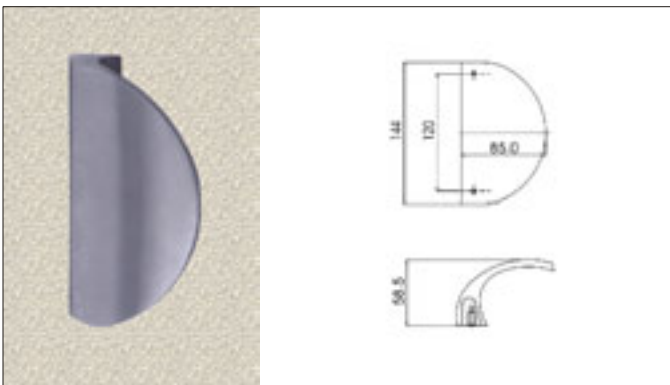

7964

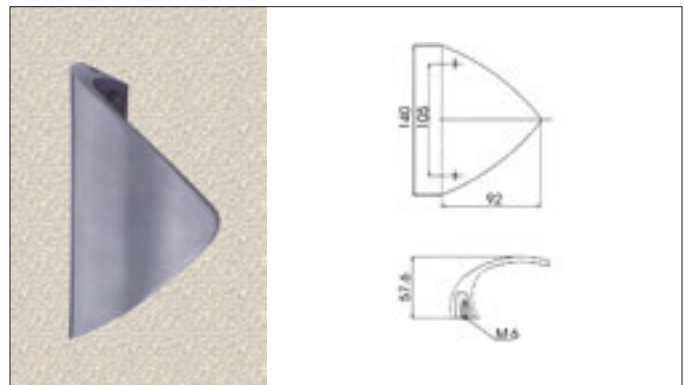

7965

Qline

CROCHETS À MANTEAUX / COAT HOOKS



Code / SKU	Dimension / Dimension	Fini / Finish	Matériel / Material	MCX / PCS
7997-1PC/HK	31 mm x 22 mm	C.P. / P.C. *	S.S. **	1
7997-2PC/HK	98 mm x 22 mm	C.P. / P.C. *	S.S. **	2
7997-4PC/HK	144 mm x 22 mm	C.P. / P.C. *	S.S. **	4

* C.P = Chrome poli / P.C. = Polished Chrome
** S.S. = Acier Inoxydable / Stainless Steel
Vis et cache-vis inclus / Screws and screw covers included

Code / SKU	Dimension / Dimension	Fini / Finish	Matériel / Material	MCX / PCS
7998-1PC/HK	62 mm x 22 mm	C.P. / P.C. *	S.S. *	1
7998-2PC/HK	98 mm x 22 mm	C.P. / P.C. *	S.S. *	2
7998-4PC/HK	244 mm x 22 mm	C.P. / P.C. *	S.S. *	4



* C.P = Chrome poli / P.C. = Polished Chrome
** S.S. = Acier Inoxydable / Stainless Steel
Vis et cache-vis inclus / Screws and screw covers included



Code / SKU	Dimension / Dimension	Fini / Finish	Matériel / Material	MCX / PCS
4672-CH	83 mm x 83 mm	Chrome	Fonte / Die Cast	1
4672-LT	83 mm x 83 mm	Laiton / Brass	Fonte / Die Cast	1

S'installe au plafond du garde-robe / To be mounted on the wardrobe ceiling
Vis et cache-vis inclus / Screws and screw covers included

Code / SKU	Dimension / Dimension	Fini / Finish	Matériel / Material	MCX / PCS
7996-2BSN/HK40	40 mm x 70 mm	Nickel Satiné Brossé / Brushed Satin Nickel	Fonte / Die Cast	1



Vis et cache-vis inclus / Screws and screw covers included

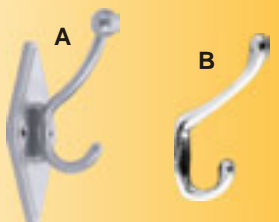

Code / SKU	Dimension / Dimension	Fini / Finish	Matériel / Material	MCX / PCS
(A) 7995-PC	89 mm x 51 mm	C.P. / P.C. *	Fonte / Die Cast	1
(A) 7995-PB	89 mm x 51 mm	L.P. / P.B. **	Fonte / Die Cast	1
(B) 4673	89 mm x 51 mm	C.P. / P.C. *	Acier / Steel	1

* C.P = Chrome poli / P.C. = Polished Chrome
** L.P = Laiton poli / P.B. = Polished Brass
Vis et cache-vis inclus / Screws and screw covers included

Code / SKU	Dimension / Dimension	Fini / Finish	Matériel / Material	MCX / PCS
7994	80 mm x 70 mm	C.P. / P.C. *	Acier / Steel	1



* C.P = Chrome poli / P.C. = Polished Chrome

Q line

PATTES DÉCORATIVES / DECORATIVE LEGS



175XX-710 Series

Couleurs (XX) / Colors (XX) :
BL, GA, MN, NR
Hauteur / Height : **710 mm**
Diamètre / Diameter : **60 mm**
(1 plaque & 1 vis de fixation inclus /
1 plate and 1 fixing screw included)

Q line®



160XX-710 Series

Couleurs (XX) / Colors (XX) :
BL, GA, MN, NR
Hauteur / Height : **710 mm**
Diamètre / Diameter : **60 x 30 mm**
(1 plaque & 1 vis de fixation inclus /
1 plate and 1 fixing screw included)



176XX-710 Series

Couleurs (XX) / Colors (XX) :
GA, MN, NB, NR
Hauteur / Height : **710 mm**
Diamètre / Diameter : **76 mm**
(1 plaque & 1 vis de fixation inclus /
1 plate and 1 fixing screw included)

Légende des codes de couleurs (les deux lettres du code produit) / Color code legend (the 2-letters in the product code)

- BL** : Blanc / White
- GA** : Gris argenté / Silver Grey
- MN** : Nickel mat / Matte nickel
- N** : Noir / Black
- NB** : Noir brillant / Glossy Black
- NR** : Noir texturé / Textured Black

• • •

D'autres finis et modèles peuvent être disponibles ou personnalisés selon vos exigences spécifiques. Contactez-nous pour plus de détails. / Other finishes and models may be available or manufactured according to your specific requirements. Please contact us for further details.

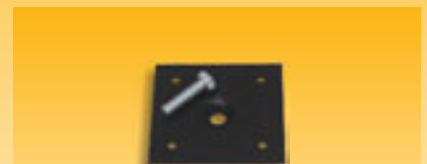

178XX-96 / 2.5

Couleurs (XX) / Colors (XX) : **GA, N**
Dimensions : **96 mm**
C.C. Trou / Hole C.C. : **64 mm**
(Système 32 mm System)
Vis de fixation en sus / Fixing screws extra



178XX-152 / 2.5

Couleurs (XX) / Colors (XX) : **GA, N**
Dimensions : **152 mm²**
C.C. Trou / Hole C.C. : **64 & 128 mm**
(Système 32 mm System)
Vis de fixation en sus / Fixing screws extra

Q line

PATTES DÉCORATIVES / DECORATIVE LEGS



Modèle / Model :

166GA-100

Hauteur / Height : **100 mm**



Modèle / Model :

173CH-120

Hauteur / Height : **120 mm**



Modèle / Model :

167GA-130

Hauteur / Height : **130 mm**



Modèles / Models :

170GA-125, 170NR-125

Hauteur / Height : **125 mm**



Modèle / Model :

165GA-100

Hauteur / Height : **100 mm**

Légende des codes de couleurs (les deux lettres du code produit) / Color code legend (the 2-letters in the product code)

CH : Chrome brillant / *Bright Chrome*
GA : Gris argenté / *Silver Grey*
NR : Noir texturé / *Textured Black*

...

D'autres finis et modèles peuvent être disponibles ou personnalisés selon vos exigences spécifiques. Contactez-nous pour plus de détails. / *Other finishes and models may be available or manufactured according to your specific requirements. Please contact us for further details.*



Modèle / Model :

168GA-120

Hauteur / Height : **120 mm**

Ensemble de treillis pour cellier / Wine Rack Kit

Disponible chez / Available at
Quinko-Tek
 1800-363-6363 / 1-800-363-6363
 1-800-363-6363 / 1-800-363-6363

SPECIAL \$82

Unités par unité / 2
 Capacité: 36 bouteilles (750 ml et 1 L)
 Matière: Acier inoxydable
 Couleur: Émaille en blanc
 Dimensions: 36" x 36"
 Hauteur maximale: 48" x 48"
 Hauteur minimale: 42" x 42"
 Hauteur maximale: 48" x 48"
 Hauteur minimale: 42" x 42"
 Montage: Facile à monter / Facile à monter / Facile à monter

Unités par unité / 2
 Capacité: 36 bouteilles (750 ml et 1 L)
 Matière: Acier inoxydable
 Couleur: Émaille en blanc
 Dimensions: 36" x 36"
 Hauteur maximale: 48" x 48"
 Hauteur minimale: 42" x 42"
 Hauteur maximale: 48" x 48"
 Hauteur minimale: 42" x 42"
 Montage: Facile à monter / Facile à monter / Facile à monter

Quinko-Tek

1800-363-6363 / 1-800-363-6363
 1-800-363-6363 / 1-800-363-6363

LEVEL ONE

Une colle constant de qualité
 The best in contact adhesives

Les meilleurs valeurs sur le marché

- Meilleure performance
- Meilleure qualité
- Meilleure valeur
- Meilleure qualité
- Meilleure valeur

PROFESIONNELS

PROFESIONNELS
 SPECIAL
 PROFESSIONNELS

Quinko-Tek

1800-363-6363 / 1-800-363-6363
 1-800-363-6363 / 1-800-363-6363

Poubelle pivotante encastrée

Finis acier inoxydable
 Panier noir amovible
 S'ouvre avec la porte et le couvercle reste à l'intérieur
 Facile à monter
 Capacité de 12 litres

\$ 26.95
 chaque / each

SPECIAL \$ 24.95

Space Saving Swivel Waste Bin

Stainless steel finish
 Removable black basket
 Opens with the cabinet door and the lid stays inside
 Easy to assemble
 Capacity of 12 liters

Quinko-Tek

1800-363-6363 / 1-800-363-6363
 1-800-363-6363 / 1-800-363-6363

LEVEL ONE

Une colle constant de qualité
 The best in contact adhesives

Les meilleurs valeurs sur le marché

- Meilleure performance
- Meilleure qualité
- Meilleure valeur
- Meilleure qualité
- Meilleure valeur

The best value on the market

- Best in quality, best performance
- Best in value
- Best in quality
- Best in value

Disponibles en formats standard et bonbonne
 Available in standard and gallon formats

Termes et conditions de vente

Toutes les commandes portent des termes de 1% - 15 jours, net 30 jours et seront livrées F.A.B. depuis notre entrepôt via le transport le moins cher.

Aucun escompte sur les commandes payées au comptant ou P.S.L. (C.O.D.).

Commande minimum : 50,00 \$

Aucun retour de marchandise ne sera accepté sans un numéro d'autorisation émis par **Quinko-Tek International**.

Terms and conditions of sales

All orders carry terms of 1% - 15 days, net 30 days and are shipped F.O.B. our warehouse via the least expensive transport.

No discount on cash or C.O.D. orders.

Minimum order : \$50.00

*Return of merchandise will not be accepted without a returned goods authorisation number from **Quinko-Tek International**.*